

## Degating Alignment Pins & Bushings

Alignment pins and bushings are a great help in providing the accuracy required for most degating applications.

Available in 3 standard lengths but can be ordered to fit your application needs. Contact EMI today to discuss your degating application.



Alignment Pins

Quick#	Part#	Price	Description
2970	GSC-20100-A	\$40.29	20mm Dia. 100mm Long Stainless Steel Alignment Pin
2971	GSC-20200-A	\$42.76	20mm Dia. 200mm Long Stainless Steel Alignment Pin
2972	GSC-20300-A	\$51.44	20mm Dia. 300mm Long Stainless Steel Alignment Pin

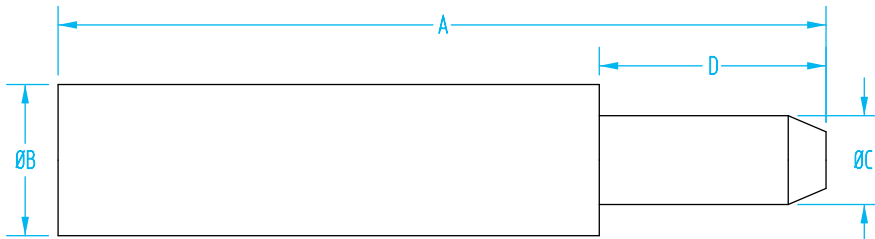

Quick#	A	B	C	D
2970	101.6	20	11.8	30
2971	203.2	20	11.8	30
2972	304.8	20	11.8	30

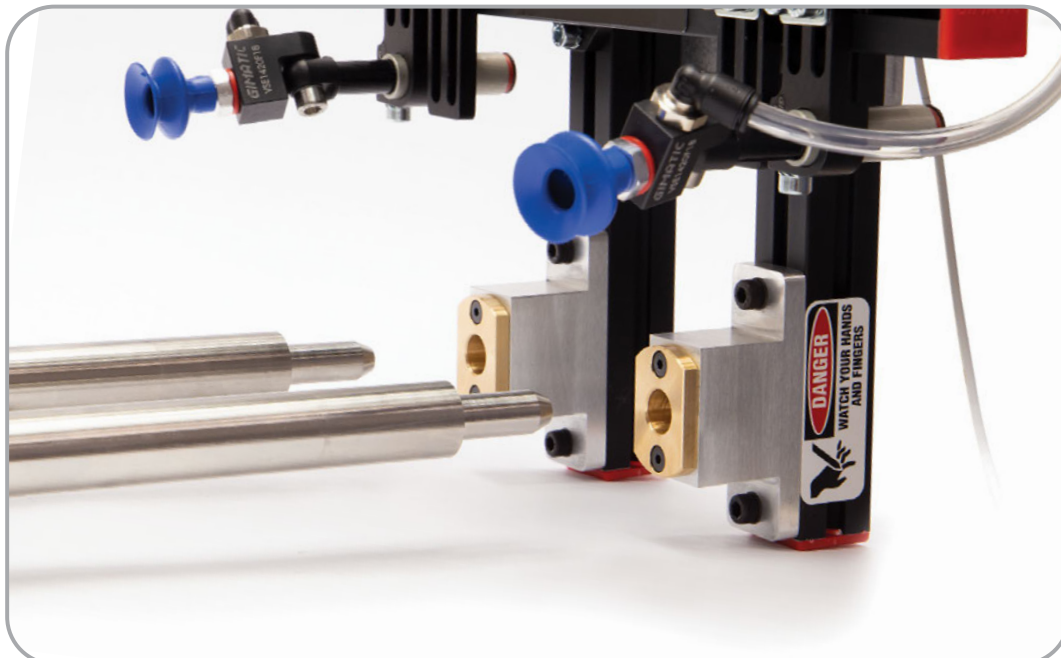

## Degating Alignment Pins & Bushings

### Alignment Bushing

Quick#	Part#	Price	Description
2969	GSC-20ABB-B	\$71.55	Alignment Bushing Bracket with Bronze Bushing & Flange

*Fasteners Included.*

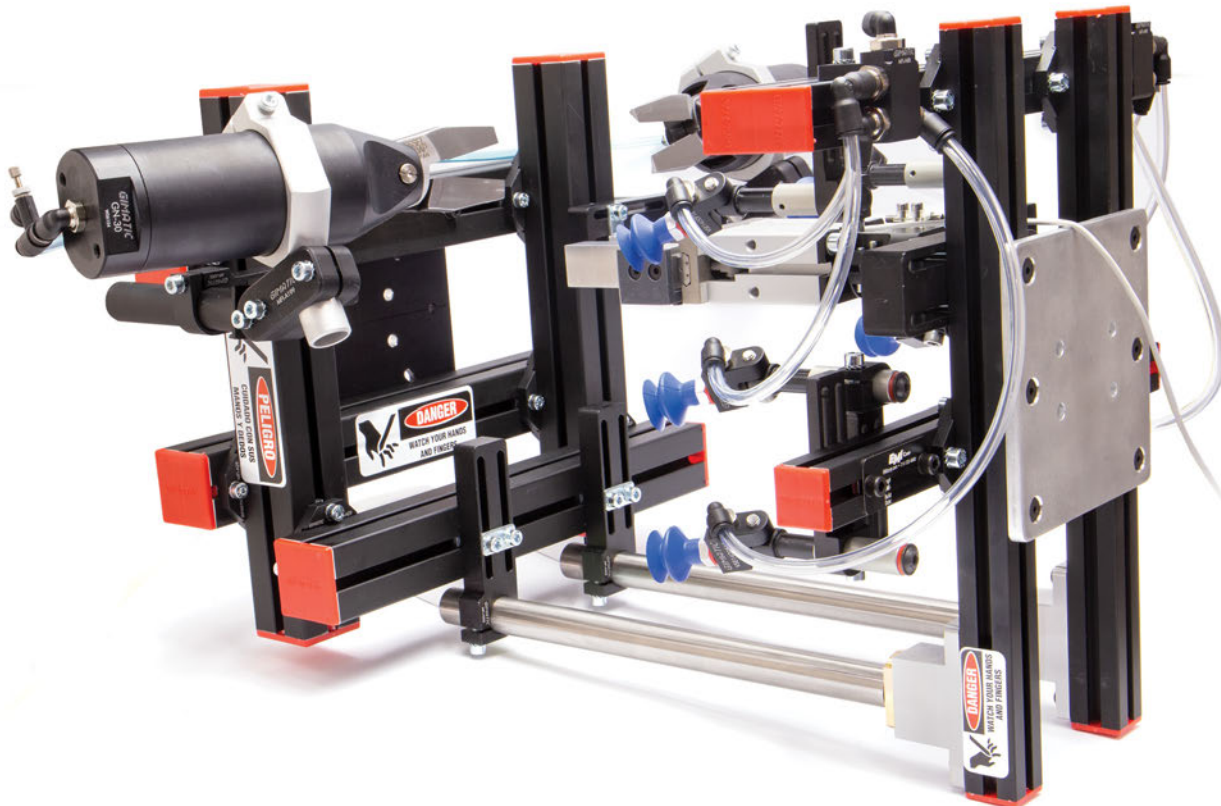
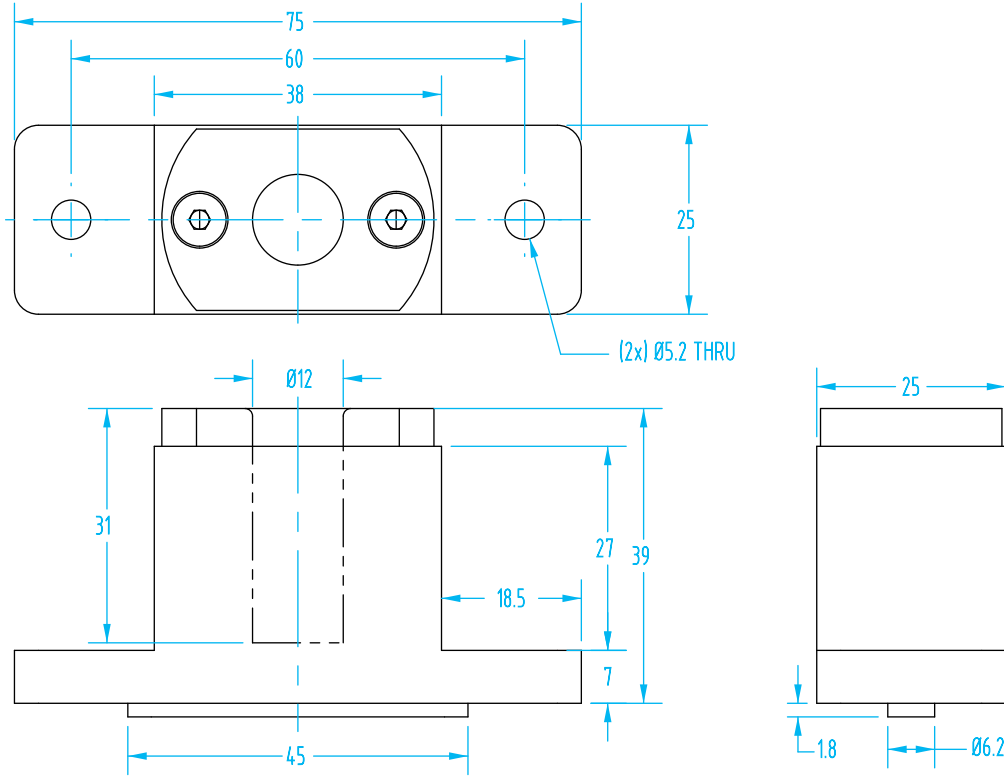

## Contact EMI for All Your Degating Applications

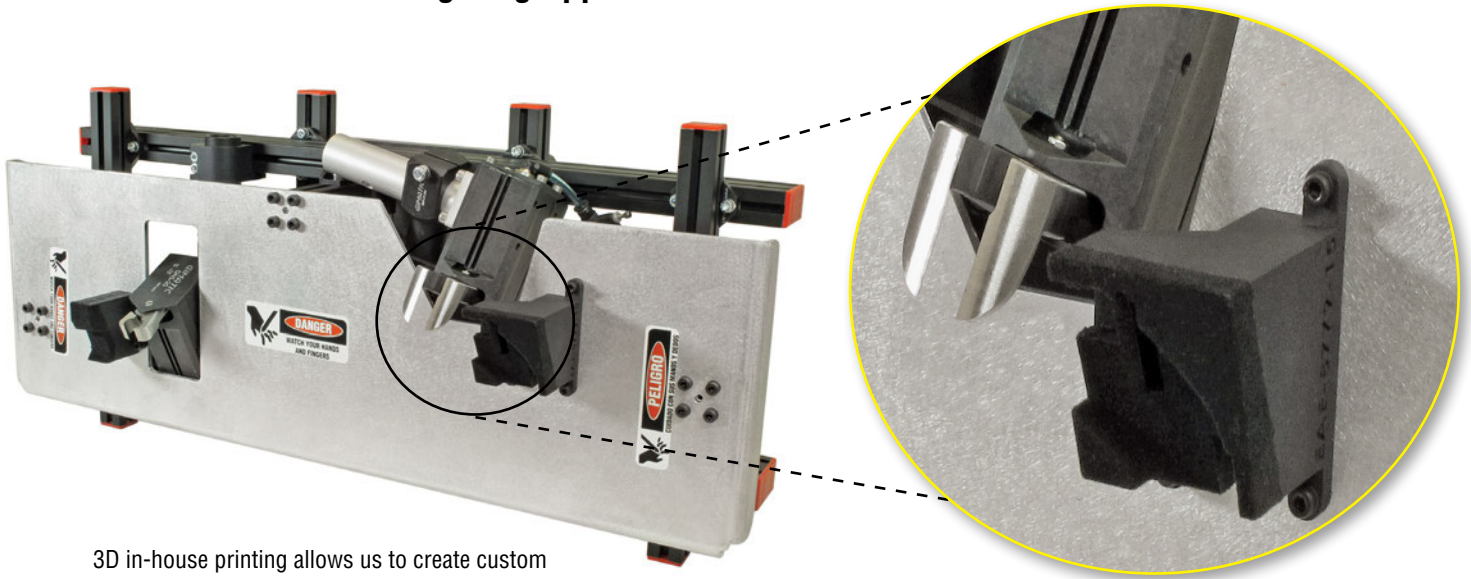

3D in-house printing allows us to create custom and cost effective nests for parts, enabling precise degating! Fiber-lined nests are used here for a soft-touch interface.

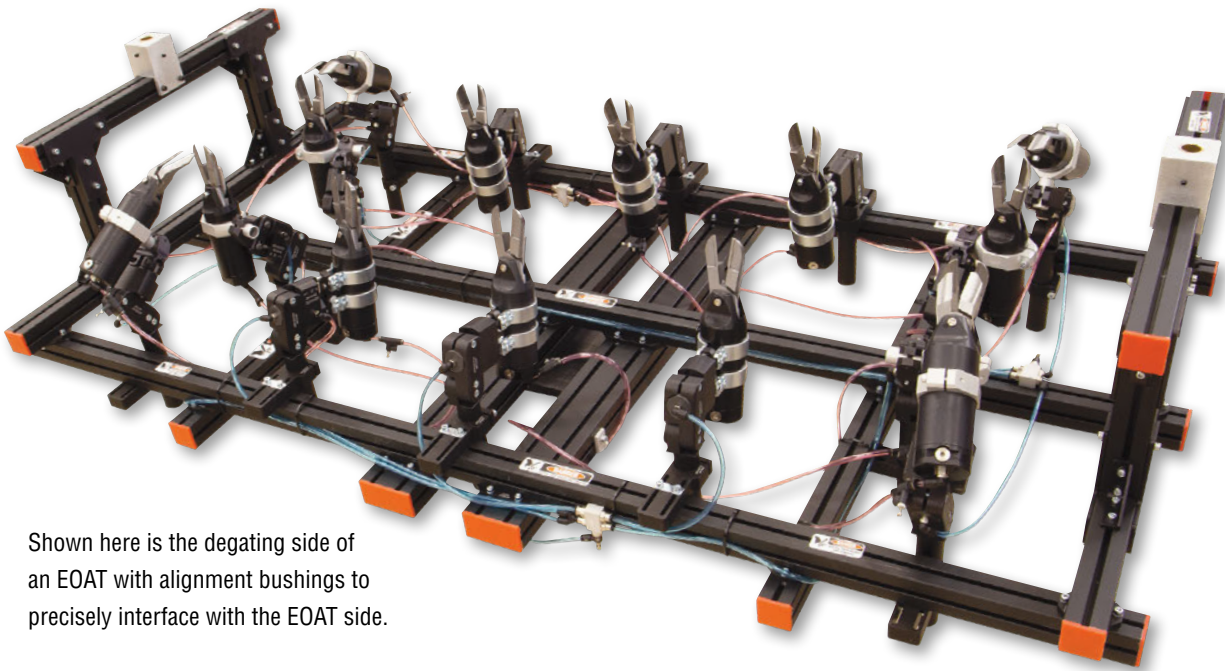

Shown here is the degating side of an EOAT with alignment bushings to precisely interface with the EOAT side.

### Degate Stand Price Examples

Stand Type	Total US\$
1m Profile Floor Mounted	\$1,319.75
1m Profile With Castors	\$1,478.43
1m Welded & Floor Mounted	\$1,250.00
2m Profile Floor Mounted	\$1,420.29
2m Profile With Castors	\$1,577.98
2m Welded & Floor Mounted	\$1,350.00

\*Castors available, Call EMI for pricing.

\*\*Pricing listed is for stands only, quick changers, lifting rings and other accessories are sold separately.

## Welded and Profile Frame Degate Stands

Manufactured in our Jackson Center, Ohio facility, these powder-coated degate stands can be custom painted per your specifications. These are completely modular and can include: quick changers, lifting hoist rings, and through holes for floor mounting.

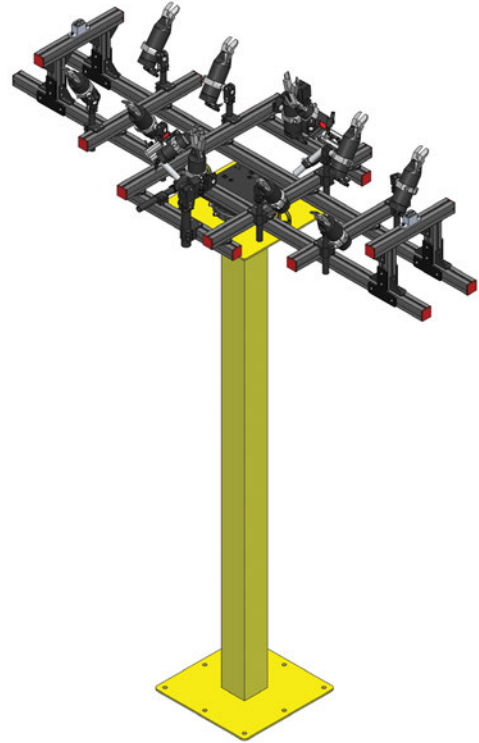

Profile based degate stands are another option from EMI. These are also modular and can include: quick changers, lifting hoist rings, and a mobile stand with locking castors.

