

Extension and Interface Cables

- Continuous flex cables can handle the high cycle requirements of many automation applications.
- Thin cables can be used when space is tight and multiple cables are required such as sensor boxes.
- Pin diagrams and other specifications can be found on our online product pages at: www.EMICorp.com
- See page 60 for OnRobot cables.
- See page 28 for Wingman cables & connectors.
- Additional cables and connectors on EMI's website.
- Contact us with any questions: Cobots@emicorp.com

Power your Cobot End Effectors!



#7714, 3-Pin M8 to M8 Interface Cable



#7160, 3-Pin Cable with M8 Connector



#7827, 8-Pin Cable with M12 Connector

Pin Diagrams:

3-Pin:

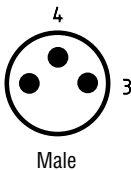
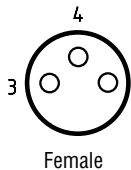

4-Pin:

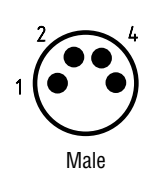
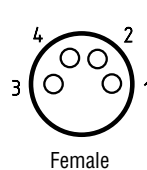

5-Pin:

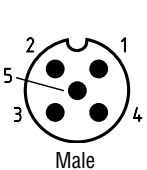
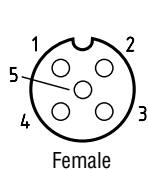

8-Pin:

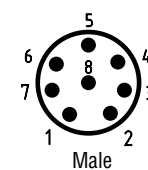
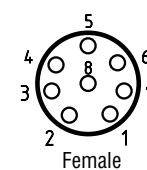

Interface Cables

(connectors on both ends)



Quick#	Part#	End 1 (to component)		Cord		End 2 (to robot)		Notes:	Price
		Pins	Connector	Length	Ø	Pins	Connector		
7712	GSE-TSC180-M803	3 (F)	M8 Straight	0.3m	2.2mm	3 (M)	M8 Straight	Thin cable	\$13.94
7713	GSE-TSC180-M805	3 (F)		0.5m	2.2mm	3 (M)		Thin cable	\$15.08
7714	GSE-TSC180-M812	3 (F)		1.2m	2.2mm	3 (M)		Thin cable	\$16.22
7335	GSE-CS180-M81	3 (F)		1m	4mm	3 (M)		Standard cable	\$17.00
7336	GSE-CS180-M82	3 (F)		2m	4mm	3 (M)		Standard cable	\$17.50
8084	CRC-650-3P	3 (F)		650mm	4mm	3 (M)		Continuous Flex	\$32.00
8085	CRC-750-3P	3 (F)		750mm	4mm	3 (M)		Continuous Flex	\$32.00
8086	CRC-1000-3P	3 (F)		1000mm	4mm	3 (M)		Continuous Flex	\$32.00
8088	CFGM8908CF8903010*	3 (F)		M8 Angled	100mm	4.3mm		8 (M)	M8 Angled
8089	CFGM8908CF8904010*	4 (F)	100mm		4.3mm	8 (M)	Standard cable	\$35.75	

Use Quick#s for easy online ordering.

Extension and Interface Cables

Extension Cables
(connector with free lead wire)



Quick#	Part#	End 1 (plug)		Cord		End 2 (free leads reference)	Notes:	Price		
		Pins	Connector	Length	Ø					
7161	CFGM890325P	3-Pin Female	M8 Angled	2.5m	4.3mm	3 wire 1 - Brown 3 - Blue 4 - Black	Continuous Flex	\$13.00		
2582	GSE-NAN-3A			5m	3.8mm		Standard cable	\$15.00		
7720	GSE-TSCE90-M825			2.5m	2.2mm		Thin cable	\$12.43		
7160	CFGM800325P			2.5m	4.3mm		Continuous Flex	\$13.00		
7159	CFGM800325		M8 Straight	2.5m	3.8mm		Standard cable	\$13.00		
2583	GSE-NAN-3F			5m	3.8mm		Standard cable	\$15.00		
7715	GSE-TSCE-M825			2.5m	2.2mm		Thin cable	\$12.43		
461	GSF-VMC-90			4-Pin Female	M8 Angled		5m	3.8mm	4 wire 1 - Brown 2 - White 3 - Blue 4 - Black	Standard cable
7719	GSE-TSCE90-M825-4P	2.5m	2.5mm			Thin cable	\$14.75			
8082	GSE-RFC-M8-4P	M8 Straight	5m		4.3mm	Continuous Flex	\$16.00			
462	GSF-VMC-S		5m		3.8mm	Standard cable	\$15.00			
7718	GSE-TSCE-M825-4P		2.5m		2.5mm	Thin cable	\$14.75			
7824	GSE-ACS-F5M12A-5M	5-Pin Female	M12 Angled	5m	6mm	5 wire 1 - Brown 2 - White 3 - Blue 4 - Black 5 - Grey	Standard cable	\$23.00		
7823	GSE-SCS-F5M12A-5M		M12 Straight	5m	5mm		Standard cable	\$23.00		
7826	GSE-ACS-M5M12A-5M	5-Pin Male	M12 Angled	5m	5mm		Standard cable	\$25.00		
7825	GSE-SCS-M5M12A-5M		M12 Straight	5m	5mm		Standard cable	\$25.00		
8087	CFGM890802P*	8-Pin Female	M8 Angled	200mm	5mm		8 wire 1 - White 2 - Brown 3 - Green 4 - Yellow 5 - Gray 6 - Pink 7 - Blue 8 - Red	Standard cable	\$33.88	
7831	GSE-ACS-F8M8-5M			5m	5mm	Standard cable		\$37.50		
2581	GSE-RCS-8FS-5000		M8 Straight	5m	5mm	Standard cable		\$26.75		
7828	GSE-ACS-F8M12A-5M			M12 Angled	5m	6mm		Standard cable	\$42.00	
7827	GSE-SCS-F8M12A-5M			M12 Straight	5m	6mm		Standard cable	\$42.00	
7832	GSE-ACS-M8M8-5M			M8 Straight	M8 Angled	5m		5mm	Standard cable	\$37.50
2580	GSE-RCS-8MS-5000		5m		5mm	Standard cable		\$40.35		
8079	CMGM800803P*		8-Pin Male		300mm	5mm		Standard cable	\$27.92	
7830	GSE-ACS-M8M12A-5M				M12 Angled	5m		6mm	Standard cable	\$42.00
7829	GSE-SCS-M8M12A-5M				M12 Straight	5m		6mm	Standard cable	\$42.00

- CU
- QC
- VG
- VC
- VA
- SG
- GR
- MT
- AC
- CS
- CC

Field Wireable Connectors

- Field wireable connectors provide a quick-disconnect and the ability to make custom length cables.
- Can be used in applications where a custom-built connections need to be added to cables.
- Pin diagrams and other specifications can be found on our online product pages at: www.EMICorp.com

Pin Diagrams:

3-Pin:

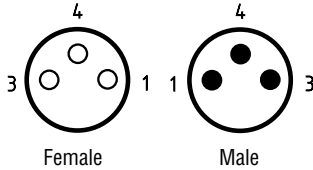

4-Pin:

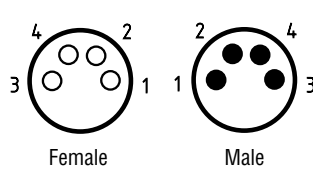

5-Pin:

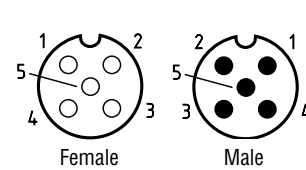

8-Pin:

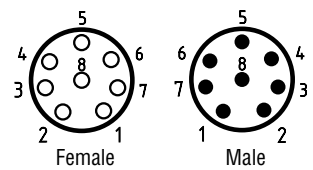

Quick#	Part#	Pins	Connector	Connection Type	Price
7810	GSE-AFC-F3M8-ST	3-Pin Female	M8 Angled	Screw Terminals	\$26.05
7284	CFGM800300		M8 Straight	Screw Terminals	\$14.00
7808	GSE-SFC-F3M8-ID		M8 Straight	Insulation Displacement Terminals	\$26.00
7811	GSE-AFC-M3M8-ST	3-Pin Male	M8 Angled	Screw Terminals	\$25.00
7285	CMGM800300		M8 Straight	Screw Terminals	\$14.00
7809	GSE-SFC-M3M8-ID		M8 Straight	Insulation Displacement Terminals	\$26.67
7814	GSE-AFC-F4M8-ST	4-Pin Female	M8 Angled	Screw Terminals	\$30.22
7699	CFGM800400		M8 Straight	Screw Terminals	\$14.00
7812	GSE-SFC-F4M8-ID		M8 Straight	Insulation Displacement Terminals	\$25.33
7815	GSE-AFC-M4M8-ST	4-Pin Male	M8 Angled	Screw Terminals	\$27.08
7698	CMGM800400		M8 Straight	Screw Terminals	\$14.00
7813	GSE-SFC-M4M8-ID		M8 Straight	Insulation Displacement Terminals	\$25.33
7817	GSE-AFC-F5M12A-ST	5-Pin Female	M12 Angled	Screw Terminals	\$25.33
7816	GSE-SFC-F5M12A-ST		M12 Straight	Screw Terminals	\$25.33
7819	GSE-AFC-M5M12A-ST	5-Pin Male	M12 Angled	Screw Terminals	\$28.00
7818	GSE-SFC-M5M12A-ST		M12 Straight	Screw Terminals	\$28.00
7822	GSE-AFC-F8M12A-ST	8-Pin Female	M12 Angled	Screw Terminals	\$33.00
7684	GSE-SFC-F8M12A-ST		M12 Straight	Screw Terminals	\$33.00
7820	GSE-AFC-F8M12A-ID		M12 Angled	Insulation Displacement Terminals	\$54.17
7686	CMGM1290800	8-Pin Male	M12 Angled	Screw Terminals	\$32.00
7821	GSE-AFC-M8M12A-ID		M12 Angled	Insulation Displacement Terminals	\$58.33
7685	GSE-SFC-M8M12A-ST		M12 Straight	Screw Terminals	\$33.00

Use Quick#s for easy online ordering.

M8 Angled Connectors with Screw Terminals:



#7810, Female 3-Pin

#7811, Male 3-Pin

M8 & 12 Straight Connector with Screw Terminals:



#7685, Male 8-Pin

#7284, Female 3-Pin

Insulation displacement connection: A type of wire termination in which the wire is punched down into a metal holder that cuts into the insulation wire and makes contact with the conductor, thus causing the electrical connection to be made. An advantage of this connection type is the insulation on the wires does not have to be stripped prior to termination, or soldered, or individually crimped.

M8 Straight Connectors with Insulation Displacement Terminals:



#7809, Male 3-Pin shown with spares that are included with these connectors.

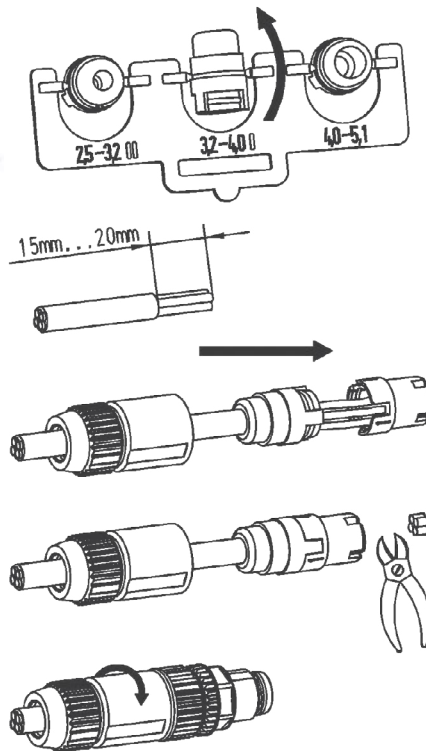

Remove the required seal.

Fully tighten seal and replace when worn.

M12 Angled Connector with Insulation Displacement Terminals:



#7820, Female 8-Pin

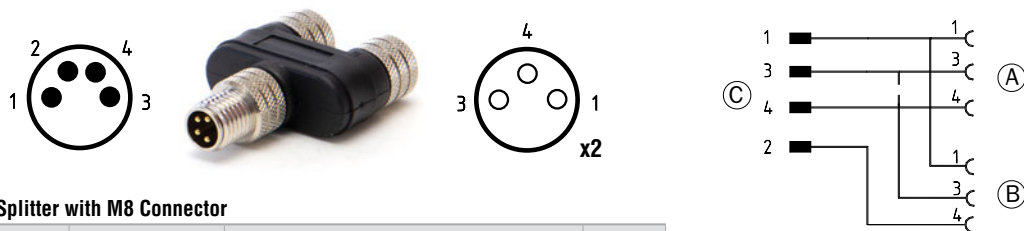

Y-Splitter with M8 Connector

Quick#	Part#	Description	Price
8081	GSE-E12269	2x M8 3-pin female, 1x M8 4-pin Male	\$41.00

Combine two sensor cables to simplify I/O requirements.

- CU
- QC
- VG
- VC
- VA
- SG
- GR
- MT
- AC
- CS
- CC