

# Dovetail Quick Changer – Robot-Side – With Fittings

(Dimensioned drawings shown 1/3 scale)

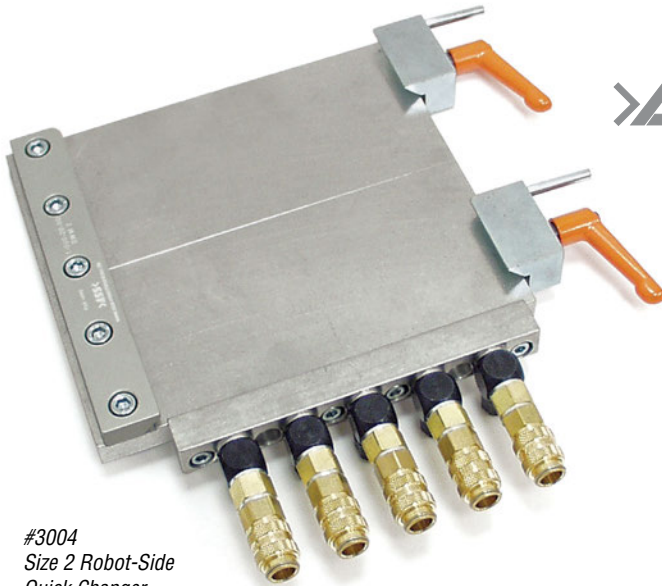

#3004  
Size 2 Robot-Side  
Quick Changer

- Five sizes available that will work with all profile systems.
- Order EOAT-Side mounting plates separately, see page 68.
- Safety loads listed on page 68.
- See page 69 for additional quick disconnect nipples.
- See page 69 for storage hangers.

SWMGR-0  
Quick#: 3002

SWMGR-01  
Quick#: 3001

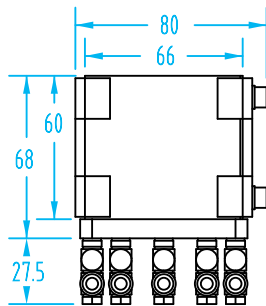
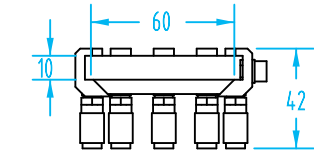
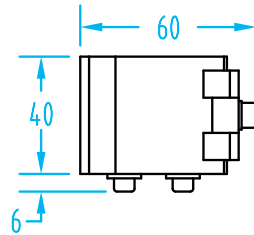
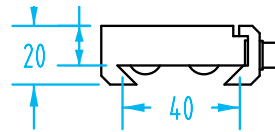

SWMGR-1  
Quick#: 3003

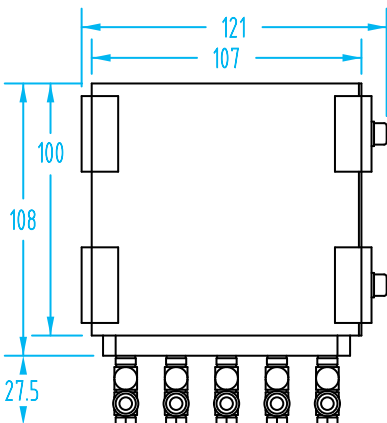
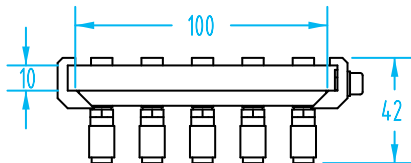

SWMGR-2  
Quick#: 3004

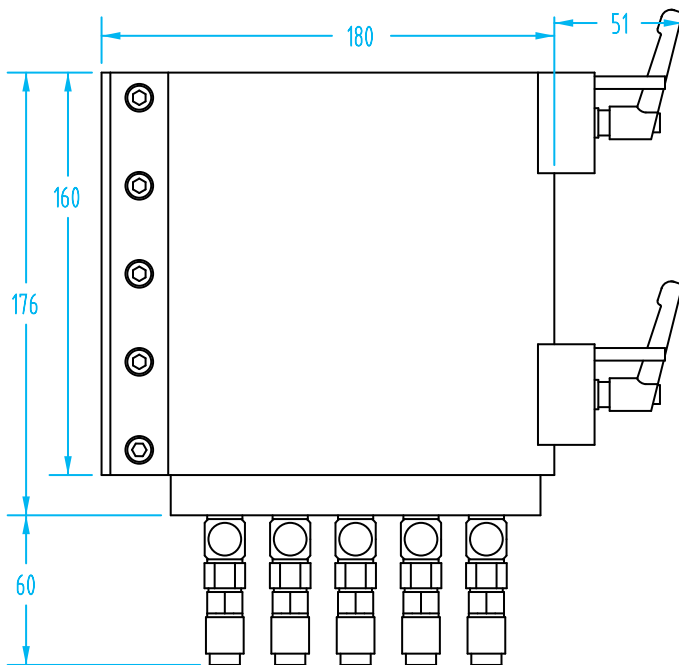
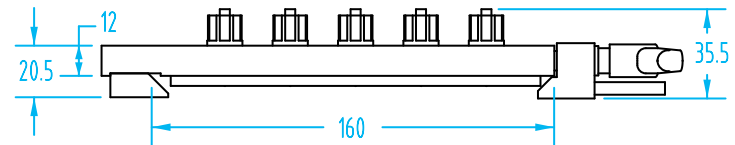

## Dovetail Quick Changer – Robot-Side – With Fittings

(Dimensioned drawings shown 1/3 scale)

**Robot Plate (with fittings)**

Quick#	Part#	>ASS< #	Price	Wt.	STN nipple size
3001	SWMGR-01	1-000-05-00	\$285.60	110g	–
3002	SWMGR-0	1-000-10-00	\$357.00	362g	M5
3003	SWMGR-1	1-000-15-00	\$467.25	570g	M5
3004	SWMGR-2	1-000-20-00	\$619.50	1772g	G1/8"
3005	SWMGR-3	1-000-25-00	\$829.50	4570g	G1/4"

**Note:** Each SWM robot-side plate includes a set of 5 plug-in nipples (not pictured).

Use Quick#s for easy online ordering.

