

# ShorTec® Dual Durometer – 1.5 Bellows

(Shown Actual Size)



## Dual Durometer Vacuum Cups!

Dual durometer-style vacuum cups are considered to be the best performing polyurethane cup and are now available at a lower price.

These blue dual durometer cups are comparable to the brand-name OEM green and yellow cups in that they use mark-free and long-lasting polyurethane, have the same dual-shore rating, and fit the same size nipples. They have a sturdy dark blue bellows with a 60° shore and a large, flexible sealing surface with a lighter blue 30° shore.

Vacuum Cup Properties

Material	Color	Max Temp.	Durometer
Polyurethane	Blue / Blue	122°F	60° / 30° Shore

Order nipples separately. See page 356–357 for nipple dimensions.

**NEW**

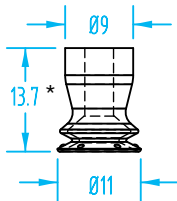

\* 11mm Compressed

Cup Ø	Material	Quick#	Part#	Price
10mm	Polyurethane	5948	15B-DD-10	\$3.78
<b>Nipple</b>	M5 Male	411	GSF-NF1-M5	\$1.75

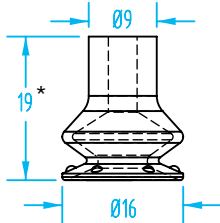

\* 15mm Compressed

Cup Ø	Material	Quick#	Part#	Price
15mm	Polyurethane	5976	15B-DD-15	\$4.46
<b>Nipple</b>	M5 Male	411	GSF-NF1-M5	\$1.75

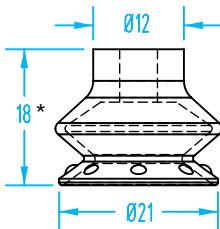

\* 12mm Compressed

Cup Ø	Material	Quick#	Part#	Price
20mm	Polyurethane	5977	15B-DD-20	\$5.04
<b>Nipple</b>	G1/8" Male	5982	F02-G8M	\$3.25
	G1/8" Female	5983	F02-G8F	\$3.25

**NEW**

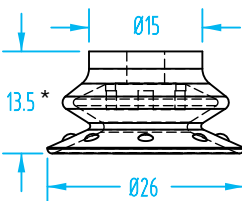

\* 8mm Compressed

Cup Ø	Material	Quick#	Part#	Price
25mm	Polyurethane	5949	15B-DD-25	\$5.88
<b>Nipple</b>	G1/8" Male	5982	F02-G8M	\$3.25
	G1/8" Female	5983	F02-G8F	\$3.25

**ShorTec® Dual Durometer – 1.5 Bellows**

(Shown Actual Size)

\* 11.5mm Compressed

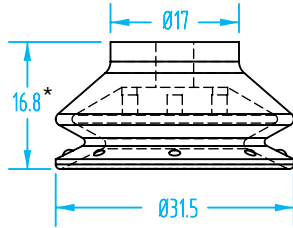
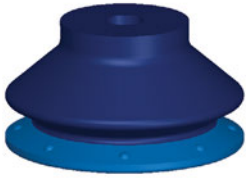

Cup Ø	Material	Quick#	Part#	Price
30mm	Polyurethane	5978	15B-DD-30	\$7.18
Nipple	G1/4" Male	5984	F03-G4M	\$4.00
	G1/4" Female	5985	F03-G4F	\$4.00

**NEW**

\* 11.5mm Compressed

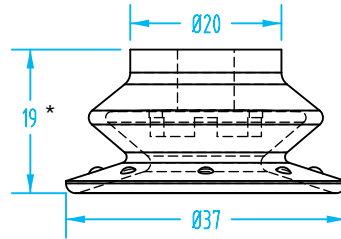

Cup Ø	Material	Quick#	Part#	Price
35mm	Polyurethane	2080	15B-DD-35	\$8.30
Nipple	G1/4" Male	5984	F03-G4M	\$4.00
	G1/4" Female	5985	F03-G4F	\$4.00

\* 16mm Compressed

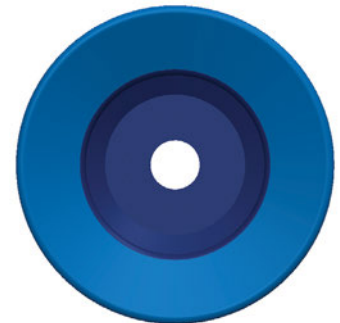
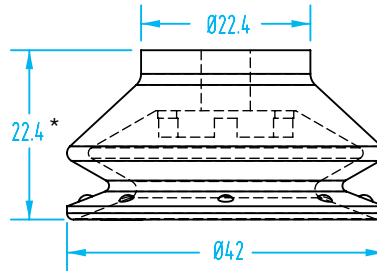
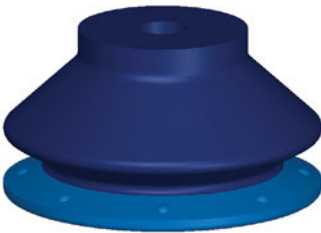

Cup Ø	Material	Quick#	Part#	Price
40mm	Polyurethane	5979	15B-DD-40	\$9.29
Nipple	G1/4" Male	5984	F03-G4M	\$4.00
	G1/4" Female	5985	F03-G4F	\$4.00

\* 21mm Compressed

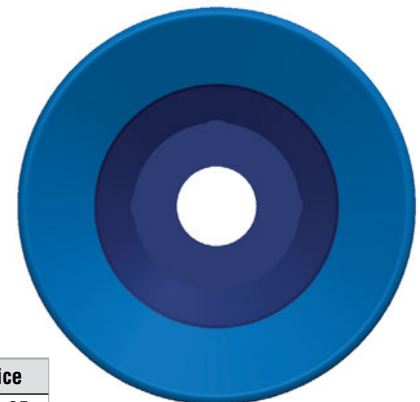
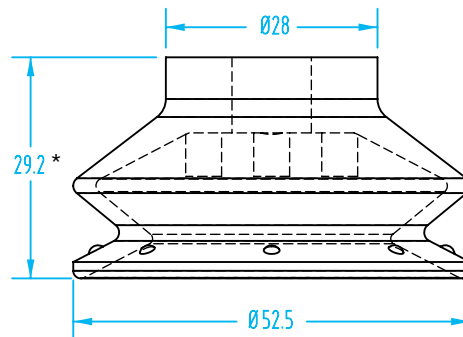

G3/8" to G1/4" reducer fittings are available on catalog page 1069.

Cup Ø	Material	Quick#	Part#	Price
50mm	Polyurethane	5980	15B-DD-50	\$10.95
Nipple	G3/8" Male	5986	F04-G3M	\$4.40
	G3/8" Female	5987	F04-G3F	\$4.40

Cup Ø	Material	Quick#	Part#	Price
70mm	Polyurethane	5981	15B-DD-70	\$22.69

Note: G3/8" Male Nipple Included