

Suction cups / FDA-compliant silicone with ring in silicone foam

VG.B16F.SFO bellows suction cups in FDA-compliant silicone with silicone foam ring

- Ideal to handle uneven and porous surfaces
- High adaptability on rough wood panels, corrugated sheet metal and non-slip sheet metal
- Ring in mark-free silicone foam



Application example



Technical features

Material	Color	Temperature range
Silicone, FDA SIL	Transparent	-67 - +392 °F

Identification codes

Drawing	Alphanumeric code	Suction cups with fitting	Order code
A	VG.B16F.50.M5F.E8.SFO	VG.B16 suction cup, FDA-compliant silicone, 50 Shore, M5 female, 8 mm hex with silicone foam ring	0321545
B	VG.B16F.50.M5M.E8.SFO	VG.B16 suction cup, FDA-compliant silicone, 50 Shore, M5 male, 8 mm hex with silicone foam ring	0321547
C	VG.B16F.50.G18F.E13.SFO	VG.B16 suction cup, FDA-compliant silicone, 50 Shore, G1/8" female, 13 mm hex with silicone foam ring	0321548
D	VG.B16F.50.G18M.E13.SFO	VG.B16 suction cup, FDA-compliant silicone, 50 Shore, G1/8" male, 13 mm hex with silicone foam ring	0321549

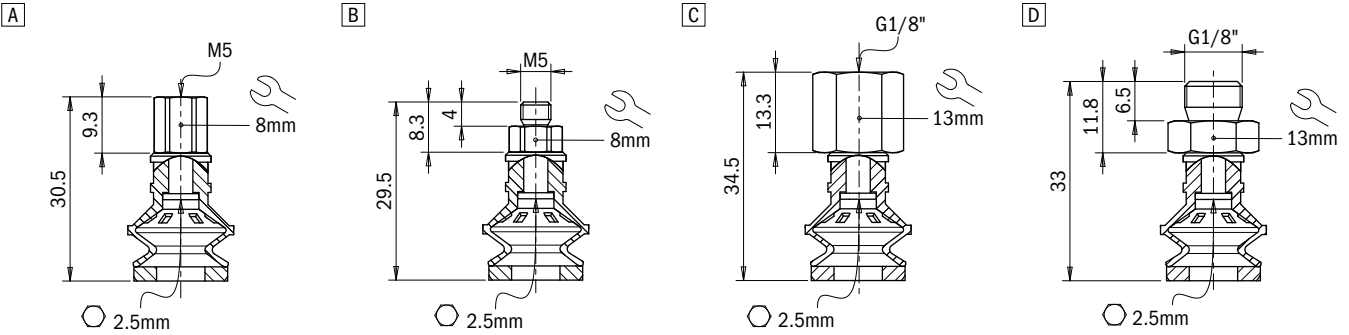

Identification codes

Drawing	Alphanumeric code	Suction cups	Order code
A	VG.B16F.SFO	VG.B16 suction cup in FDA-compliant silicone, 50 Shore, with silicone foam ring	0321546

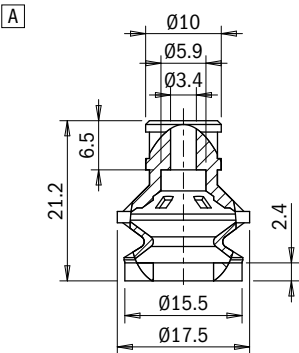

Identification codes

Drawing	Alphanumeric code	Fittings	Order code
A	FT.M5F.E8	M5 female fitting, 8 mm hex	2321408
B	FT.M5M.E8	M5 male fitting, 8 mm hex	2321410
C	FT.G18F.E13	G1/8" female fitting, 13 mm hex	2321412
D	FT.G18M.E13	G1/8" male fitting, 13 mm hex	2321414

