

Suction cups / FDA-compliant silicone with ring in silicone foam

VG.B53F.SFO bellows suction cups in FDA-compliant silicone with silicone foam ring

- Ideal to handle uneven and porous surfaces
- High adaptability on rough wood panels, corrugated sheet metal and non-slip sheet metal
- Ring in mark-free silicone foam



Application example

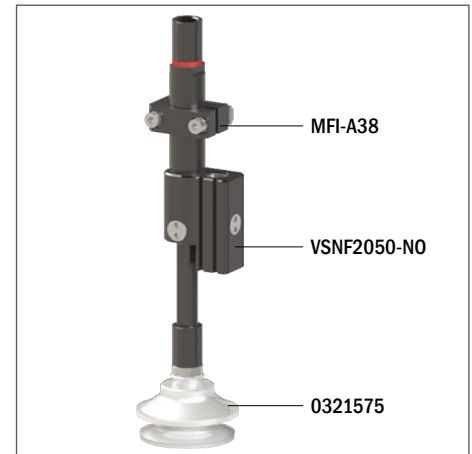

Technical features

Material	Color	Temperature range
Silicone, FDA SIL	Transparent	-67 - +392 °F

Identification codes

Drawing	Alphanumeric code	Suction cups with fitting	Order code
A	VG.B53F.50.G18F.E12.SFO	VG.B53 suction cup, FDA-compliant silicone, 50 Shore, G1/8" female, 12 mm hex with silicone foam ring	0321569
B	VG.B53F.50.G18M.E12.SFO	VG.B53 suction cup, FDA-compliant silicone, 50 Shore, G1/8" male, 12 mm hex with silicone foam ring	0321571
C	VG.B53F.50.G18F.E16.SFO	VG.B53 suction cup, FDA-compliant silicone, 50 Shore, G1/8" female, 16 mm hex with silicone foam ring	0321572
D	VG.B53F.50.G18M.E16.SFO	VG.B53 suction cup, FDA-compliant silicone, 50 Shore, G1/8" male, 16 mm hex with silicone foam ring	0321573
E	VG.B53F.50.G14F.E16.SFO	VG.B53 suction cup, FDA-compliant silicone, 50 Shore, G1/4" female, 16 mm hex with silicone foam ring	0321574
F	VG.B53F.50.G14M.E17.SFO	VG.B53 suction cup, FDA-compliant silicone, 50 Shore, G1/4" male, 17 mm hex with silicone foam ring	0321575

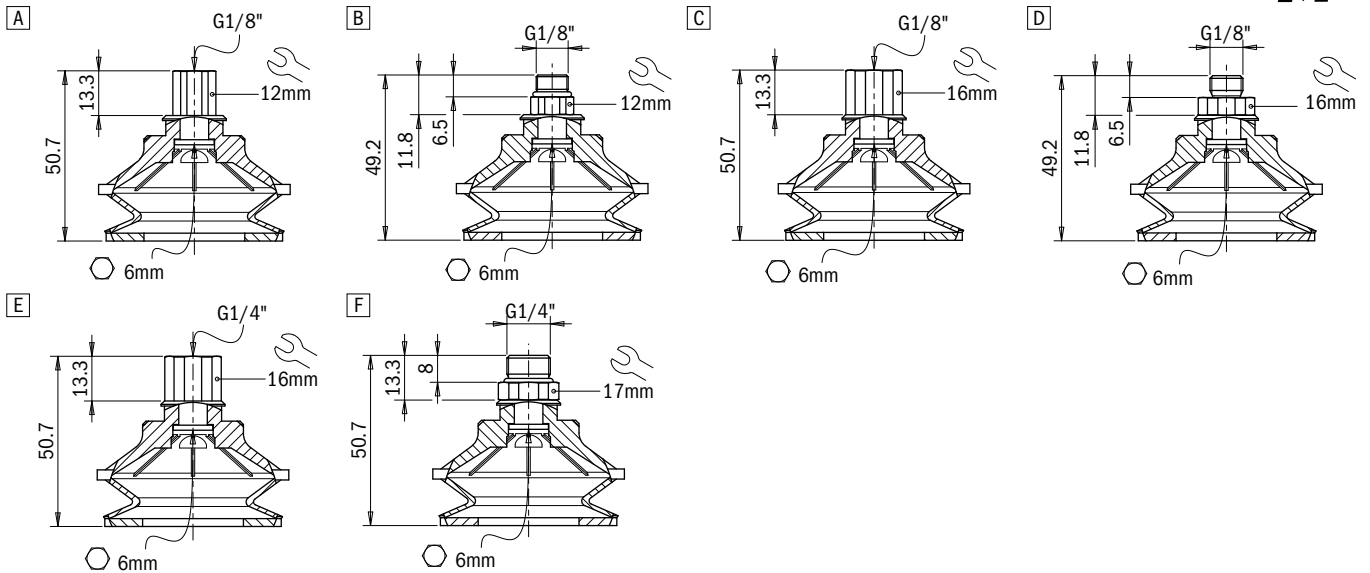

Identification codes

Drawing	Alphanumeric code	Suction cups	Order code
A	VG.B53F.SFO	VG.B53 suction cup in FDA-compliant silicone, 50 Shore, with silicone foam ring	0321570

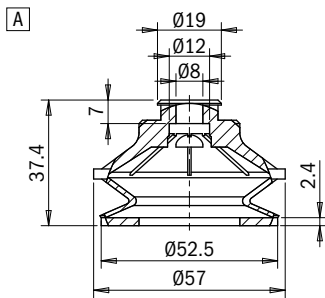

Identification codes

Drawing	Alphanumeric code	Fittings	Order code
A	FT.G18F.E12	G1/8" female fitting, 12 mm hex	2321422
B	FT.G18M.E12	G1/8" male fitting, 12 mm hex	2321424
C	FT.G18F.E16	G1/8" female fitting, 16 mm hex	2321426
D	FT.G18M.E16	G1/8" male fitting, 16 mm hex	2321428
E	FT.G14F.E16	G1/4" female fitting, 16 mm hex	2321430
F	FT.G14M.E17	G1/4" male fitting, 17 mm hex	2321432

