

Vacuum Cups Overview

Hithane® p.204



A hybrid, high-temperature, non-silicone, non-marking cup good for use with hot plastic parts.
Maximum temperature 320°F.
Good flexibility.

Material	Flat w/Ribs	Flat	Oval	1.5 Bellows	2.5 Bellows
Silicone					
Polyurethane					
Hybrid	8–50mm		4–75mm	14–53mm	7–42mm
Nitrile					

OEM Replacement p.214



Now available in Hithane.
The translucent clear silicone cups are very nice quality.
Ideal for customers wanting non-colored silicone cups.
Popular design fits PIAB nipples.
Non-branded for OEM applications.

Material	Flat w/Ribs	Flat	Deep	1.5 Bellows	2.5 Bellows
Silicone	16–50mm	5–50mm		5–50mm	
Hithane®	16–50mm	5–50mm		5–50mm	
Polyurethane					
Nitrile	16–50mm	5–50mm		5–50mm	

Piab® p.220



Excellent performing silicone.
Low-cost chloroprene for lower temperature, non-critical applications.

Material	Flat w/Ribs	Flat	Deep	1.5 Bellows	2.5 Bellows
Silicone	15–75mm	2–50mm	15–50mm	5–50mm	
Polyurethane	15–50mm			15–50mm	
Chloroprene	15–30mm	4–20mm	15–50mm	5–40mm	
Nitrile	40–75mm	30–50mm	15–50mm	50mm	

>S< Style p.242



Good quality, high performing vacuum cups in a broad size and material range.
Silicone maximum temperature 482°F.
Polyurethane max. temperature 248°F.
New Foam cups!

Material	Foam	Foam, 1.5 Bellows	Flat	1.5 Bellows	2.5 Bellows
Silicone	15–50mm	20–50mm	2–95mm	10–75mm	5–90mm
Polyurethane			2–95mm	10–75mm	5–90mm
Nitrile	15–50mm	20–50mm	2–95mm	10–75mm	5–90mm

SMC® p.256



We make ordering SMC vacuum cups easy. See step by step ordering guide on page 257.
Good variety of alternate vacuum entries with push-in fittings and barbed fittings.

Material	Flat w/Ribs	Flat	Deep	1.5 Bellows	2.5 Bellows
Silicone	10–50mm	2–50mm	10–40mm	6–50mm	
Polyurethane	10–50mm	2–50mm	10–40mm	6–50mm	
Anti-Static		2–16mm		6–16mm	
Nitrile	10–50mm	2–50mm	10–40mm	6–50mm	

Senvex® p.274



One-nipple-size-fits-all Senvex cups make it easy to standardize with fewer nipples, suspensions, and mounting brackets.
Nipple-integrated suspensions are also available.

Material	Flat w/Ribs	Flat	Deep	1.5 Bellows	2.5 Bellows
Silicone	10–40mm			10–40mm	
Polyurethane	10–40mm			10–40mm	
Special PU					
Nitrile					

Star® p.282



Very nice quality vacuum cups.
Two nipple sizes fit the entire range.
Nipple integrated suspensions are available.

Material	Flat w/Ribs	Flat	Deep	1.5 Bellows	2.5 Bellows
Silicone	15–20mm	6–45mm			6–40mm
Polyurethane					
Fluorine		6–40mm			12–20mm
Nitrile					

Apex® p.278



Long lasting, slightly thicker silicone.
One-nipple-size-fits-all.
Good quality, basic vacuum cups.

Material	Flat w/Ribs	Flat	Deep	1.5 Bellows	2.5 Bellows
Silicone	10–50mm			5–40mm	
Polyurethane					
Special PU					
Nitrile					

Vacuum Cups Overview

Material	Flat w/Ribs	Flat	Oval	1.5 Bellows	2.5 Bellows
Silicone		11–53mm		11–53mm	
EPDM		11–53mm		11–53mm	
HNBR		11–53mm		11–53mm	
Natural Rubber		11–53mm		11–53mm	

<p>Gimatic® p.268</p>  <p>Great value! Available in two styles: flat or with 1.5 bellows. Four materials: Silicone, EPDM, and HNBR. *Call EMI for Natural Rubber cups. Diameter from 11mm to 53mm.</p>	<p>For Carbon Fiber p.302</p>  <p>PTFE vacuum cups do not stick to hot carbon fiber parts (up to 480°F) Used in applications where needle grippers would puncture and damage the structure of composites. Supporting ribs avoid suction and deformation of soft materials.</p>	<p>Aclathane® p.308</p>  <p>A special, long-life, non-marking polyurethane. Maximum temperature 212°F. Relatively stiff.</p>	
<p>Duraflex® p.228</p>  <p>One of the best polyurethane cups for use with EOAT. Green PU is stiffer to provide excellent part support when carrying the part vertically. Yellow PU is very flexible to provide excellent sealing. 1.5 & 2.5 bellows 11–75mm.</p>	<p>Foam p.288</p>  <p>Very soft, closed-cell silicone foam vacuum cups for textured surfaces. Flat 8–40mm. 1.5 bellows 20–60mm.</p>	<p>ShorTec® with Larger Lip p.232</p>  <p>These new dual durometer cups offer excellent quality and feature a larger and more flexible lip. Available at a lower price compared to other similar polyurethane cups. Made of mark-free polyurethane. 2.5 bellows 25–55mm.</p>	<p>ShorTec® p.234</p>  <p>These dual durometer cups offer excellent quality and features like the popular brand name dual durometer cups, but at a lower price. Made of mark-free polyurethane. 1.5 & 2.5 bellows 15–40mm.</p>
<p>Packaging & Paper p.305</p>  <p>DURAFLEX® mark-free material features the elasticity of rubber in combination with the wear resistance of polyurethane. High-flow fitting allows for high initial vacuum flow needed for bag handling. 30–40mm.</p>	<p>Paper & Foil p.306</p>  <p>Special ridges keep paper, foil, and other thin material from being sucked into the cup. Natural rubber vacuum cups 15–40mm.</p>	<p>Oval p.290</p>  <p>From 5x15mm to 20x60mm. Translucent silicone. Hard to find 2.5 bellows silicone.</p>	<p>Hi-Speed p.304</p>  <p>Optimized for high speed attachment and release. Great for high speed thin wall molding applications. Silicone and very flexible polyurethane materials.</p>
<p>Mini p.294</p>  <p>For those tiny parts, vacuum cups as small as Ø1mm. Flat, 1.5 bellows, and 2.5 bellows.</p>	<p>Long Neck p.273</p>  <p>Translucent silicone. 6–25mm. Softer durometer. Good for small parts.</p>	<p>Anti-Static p.258</p>  <p>Anti-Static vacuum cups are typically used in electronic, packaging, and small parts applications. These are from the SMC family of vacuum cups. Available in Flat, and 1.5 bellows up to 16mm.</p>	<p>4.5 Bellows p.312</p>  <p>Great for use with angled and contoured surfaces. Translucent silicone. 20–50mm.</p>

Vacuum Cups

Hithane® - Flat

(Shown Actual Size)



Hithane - Time Proven!

This hybrid non-marking cup combines the high-temperature and flexibility properties of silicone with the wear resistance and non-marking properties of polyurethane.

It contains no silicone so it is suitable to be used with parts that will be painted.

Hithane is designed not to leave residue, mold release marks, or ghost marks on hot, injection molded plastic parts.

Hithane Vacuum Cup Properties

Material	Color	Max Temp.	Durometer
Hithane	Blue	320°F	55°

See page 212-213 for nipple dimensions.

Vacuum Cups

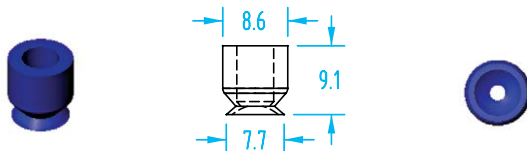

Cup Ø	Material	Quick#	Part#	Price
8mm	Hithane	1645	GSV-FHT-8	\$5.01
Nipple	Female M5	5431	GSF-HTN1-M5F	\$3.59
	Male M5	408	GSF-N16-M5M	\$3.35

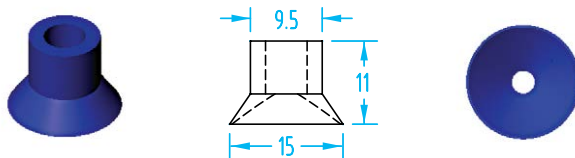

Cup Ø	Material	Quick#	Part#	Price
15mm	Hithane	1646	GSV-FHT-15	\$6.31
Nipple	Female M5	5431	GSF-HTN1-M5F	\$3.59
	Male M5	408	GSF-N16-M5M	\$3.35
	Male G1/8"	1604	GSF-PFN-G8M	\$3.80
	Female G1/8"	1603	GSF-PFN-G8F	\$3.80

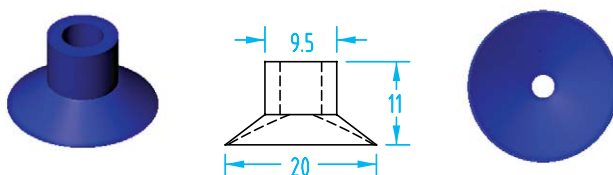

Cup Ø	Material	Quick#	Part#	Price
20mm	Hithane	1647	GSV-FHT-20	\$5.01
Nipple	Female M5	5431	GSF-HTN1-M5F	\$3.59
	Male M5	408	GSF-N16-M5M	\$3.35
	Male G1/8"	1604	GSF-PFN-G8M	\$3.80
	Female G1/8"	1603	GSF-PFN-G8F	\$3.80

Hithane® - Flat

(Shown Actual Size)

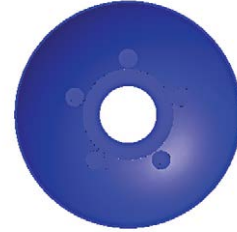
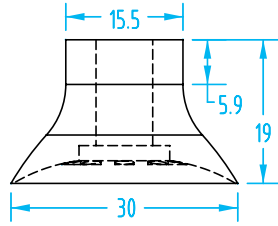

Cup Ø	Material	Quick#	Part#	Price
30mm	Hithane	1648	GSV-FHT-30	\$7.50
Nipple	Female G1/8"	5432	GSF-HTN1-G8F	\$3.67
	Male G1/8"	5433	GSF-HTN1-G8M	\$3.67
	Female G1/4"	1744	GSF-HTN4-G4F	\$6.46
	Male G1/4"	1743	GSF-HTN4-G4M	\$6.45

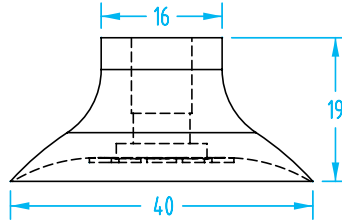

Cup Ø	Material	Quick#	Part#	Price
40mm	Hithane	1649	GSV-FHT-40	\$13.45
Nipple	Female G1/8"	5432	GSF-HTN1-G8F	\$3.67
	Male G1/8"	5433	GSF-HTN1-G8M	\$3.67
	Female G1/4"	1744	GSF-HTN4-G4F	\$6.46
	Male G1/4"	1743	GSF-HTN4-G4M	\$6.45

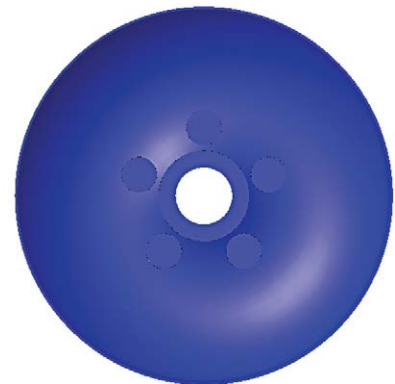
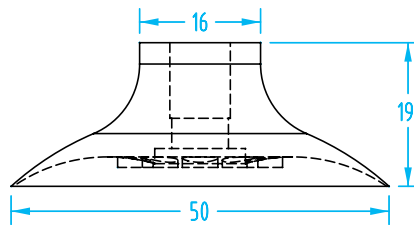

Cup Ø	Material	Quick#	Part#	Price
50mm	Hithane	1650	GSV-FHT-50	\$10.06
Nipple	Female G1/8"	5432	GSF-HTN1-G8F	\$3.67
	Male G1/8"	5433	GSF-HTN1-G8M	\$3.67
	Female G1/4"	1744	GSF-HTN4-G4F	\$6.46
	Male G1/4"	1743	GSF-HTN4-G4M	\$6.45

Fittings Available
on page 935



Hithane® - 1.5 Bellows

(Shown Actual Size)



Hithane - Time Proven!

This hybrid non-marking cup combines the high-temperature and flexibility properties of silicone with the wear resistance and non-marking properties of polyurethane.

It contains no silicone so it is suitable to be used with parts that will be painted.

Hithane is designed not to leave residue, mold release marks, or ghost marks on hot, injection molded plastic parts.

Hithane Vacuum Cup Properties

Material	Color	Max Temp.	Durometer
Hithane	Blue	320°F	55°

See page 212-213 for nipple dimensions.

Vacuum Cups

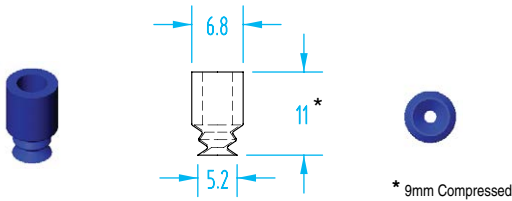

Cup Ø	Material	Quick#	Part#	Price
5mm	Hithane	5988	GSV-BHT-5	\$10.93
Nipple	Male M5	258	GSF-BS-M506	\$0.78
	Female M5	1070	ZPT1B5	\$3.10

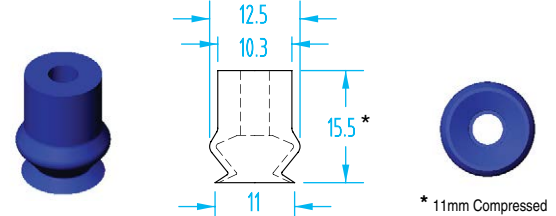

Cup Ø	Material	Quick#	Part#	Price
11mm	Hithane	5989	GSV-BHT-11	\$6.83
Nipple	Male M5	408	GSF-N16-M5M	\$3.35
	Female M5	5431	GSF-HTN1-M5F	\$3.59

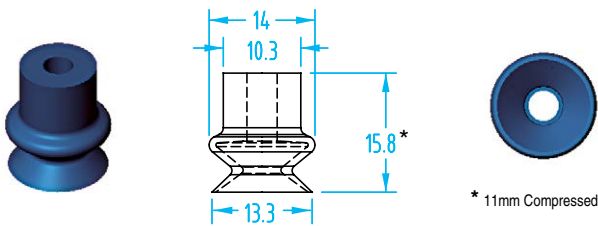

Cup Ø	Material	Quick#	Part#	Price
14mm	Hithane	1651	GSV-BHT-14	\$6.04
Nipple	Male M5	408	GSF-N16-M5M	\$3.35
	Female M5	5431	GSF-HTN1-M5F	\$3.59
	Male G1/8"	1604	GSF-PFN-G8M	\$3.80
	Female G1/8"	1603	GSF-PFN-G8F	\$3.80

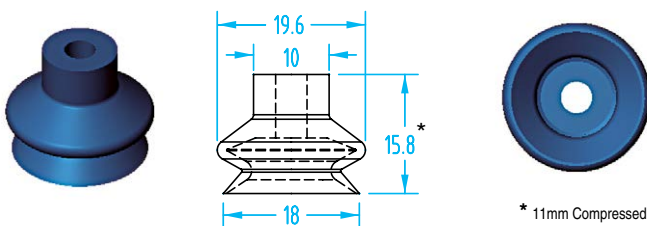

Cup Ø	Material	Quick#	Part#	Price
20mm	Hithane	1652	GSV-BHT-20	\$7.32
Nipple	Male M5	408	GSF-N16-M5M	\$3.35
	Female M5	5431	GSF-HTN1-M5F	\$3.59
	Male G1/8"	1604	GSF-PFN-G8M	\$3.80
	Female G1/8"	1603	GSF-PFN-G8F	\$3.80

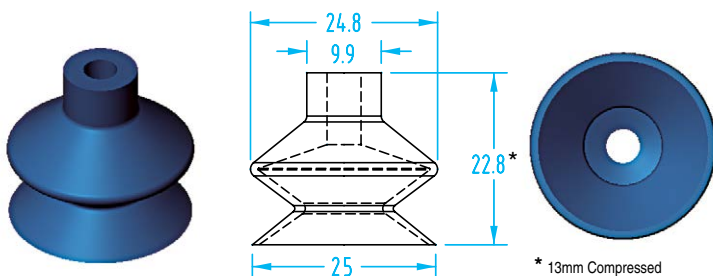

Cup Ø	Material	Quick#	Part#	Price
25mm	Hithane	1653	GSV-BHT-25	\$7.44
Nipple	Male M5	408	GSF-N16-M5M	\$3.35
	Female M5	5431	GSF-HTN1-M5F	\$3.59
	Male G1/8"	1604	GSF-PFN-G8M	\$3.80
	Female G1/8"	1603	GSF-PFN-G8F	\$3.80

Hithane® - 1.5 Bellows

(Shown Actual Size)

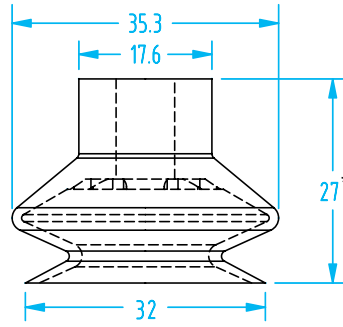
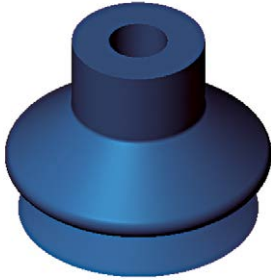

* 19mm Compressed



Cup Ø	Material	Quick#	Part#	Price
33mm	Hithane	1654	GSV-BHT-33	\$10.15
Nipple	Female G1/8"	5432	GSF-HTN1-G8F	\$3.67
	Male G1/8"	5433	GSF-HTN1-G8M	\$3.67
	Female G1/4"	1744	GSF-HTN4-G4F	\$6.46
	Male G1/4"	1743	GSF-HTN4-G4M	\$6.45

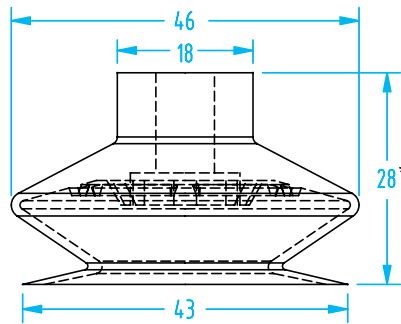
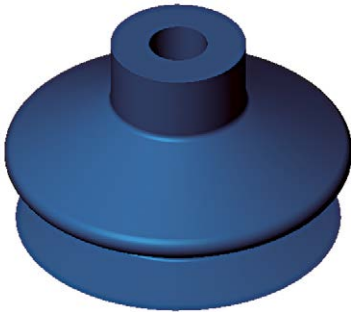

* 19mm Compressed

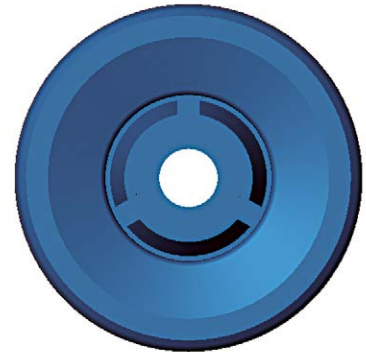

Cup Ø	Material	Quick#	Part#	Price
43mm	Hithane	1655	GSV-BHT-43	\$11.21
Nipple	Female G1/8"	5432	GSF-HTN1-G8F	\$3.67
	Male G1/8"	5433	GSF-HTN1-G8M	\$3.67
	Female G1/4"	1744	GSF-HTN4-G4F	\$6.46
	Male G1/4"	1743	GSF-HTN4-G4M	\$6.45

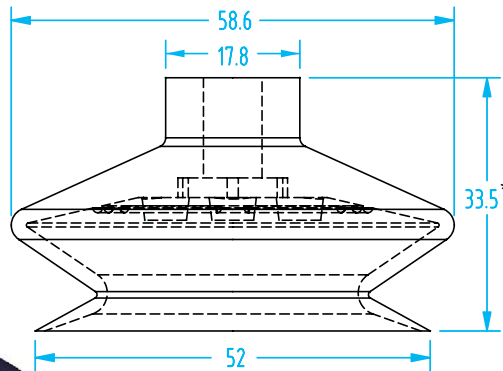
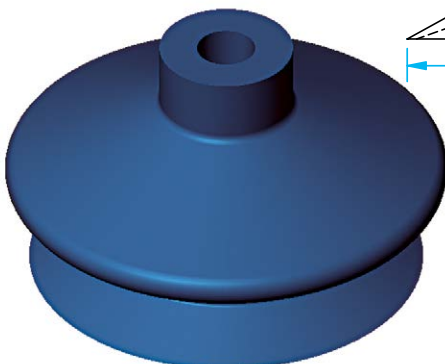

* 21mm Compressed

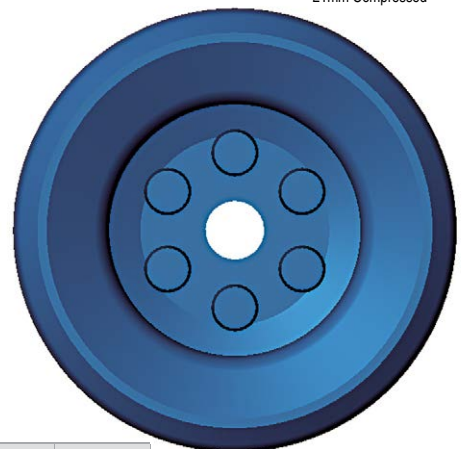

Cup Ø	Material	Quick#	Part#	Price
53mm	Hithane	1656	GSV-BHT-53	\$12.18
Nipple	Female G1/8"	5432	GSF-HTN1-G8F	\$3.67
	Male G1/8"	5433	GSF-HTN1-G8M	\$3.67
	Female G1/4"	1744	GSF-HTN4-G4F	\$6.46
	Male G1/4"	1743	GSF-HTN4-G4M	\$6.45

Hithane® - 2.5 Bellows

(Shown Actual Size)



Hithane Vacuum Cup Properties

Material	Color	Max Temp.	Durometer
Hithane	Blue	320°F	55°

See page 212–213 for nipple dimensions.

Vacuum Cups

* 9mm Compressed

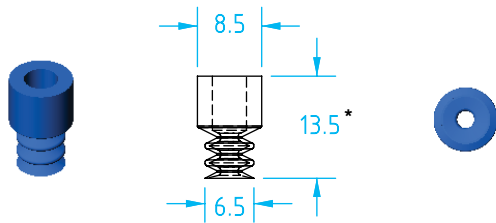

Cup Ø	Material	Quick#	Part#	Price
7mm	Hithane	5442	GSV-2BHT-7	\$8.60
Nipple	Male M5	408	GSF-N16-M5M	\$3.35
	Female M5	5431	GSF-HTN1-M5F	\$3.59

* 11.5mm Compressed

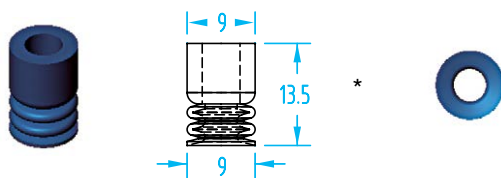

Cup Ø	Material	Quick#	Part#	Price
9mm	Hithane	1657	GSV-2BHT-9	\$6.83
Nipple	Male M5	408	GSF-N16-M5M	\$3.35
	Female M5	5431	GSF-HTN1-M5F	\$3.59
	Male G1/8"	1604	GSF-PFN-G8M	\$3.80
	Female G1/8"	1603	GSF-PFN-G8F	\$3.80

* 12.25mm Compressed

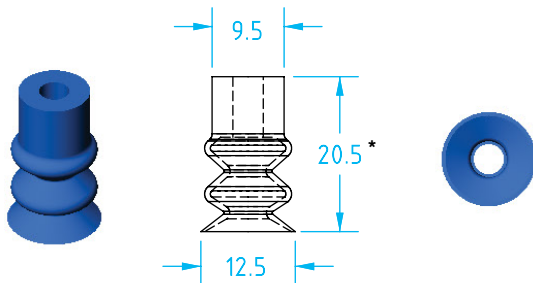

Cup Ø	Material	Quick#	Part#	Price
12mm	Hithane	5443	GSV-2BHT-12	\$7.40
Nipple	Male M5	408	GSF-N16-M5M	\$3.35
	Female M5	5431	GSF-HTN1-M5F	\$3.59
	Male G1/8"	1604	GSF-PFN-G8M	\$3.80
	Female G1/8"	1603	GSF-PFN-G8F	\$3.80

* 14mm Compressed

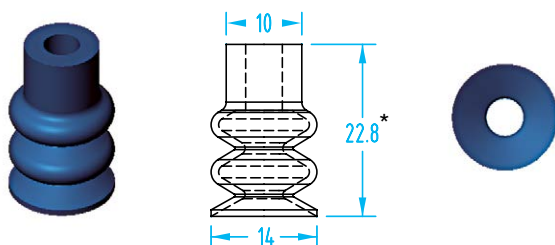

Cup Ø	Material	Quick#	Part#	Price
14mm	Hithane	1658	GSV-2BHT-14	\$7.07
Nipple	Male M5	408	GSF-N16-M5M	\$3.35
	Female M5	5431	GSF-HTN1-M5F	\$3.59

Hithane® - 2.5 Bellows

(Shown Actual Size)

* 14mm Compressed

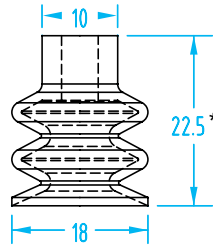

Cup Ø	Material	Quick#	Part#	Price
18mm	Hithane	1659	GSV-2BHT-18	\$7.07
Nipple	Male M5	408	GSF-N16-M5M	\$3.35
	Female M5	5431	GSF-HTN1-M5F	\$3.59

* 16mm Compressed

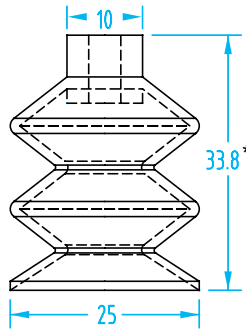
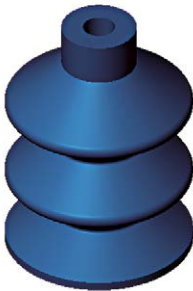

Cup Ø	Material	Quick#	Part#	Price
25mm	Hithane	1660	GSV-2BHT-25	\$11.19
Nipple	Male M5	408	GSF-N16-M5M	\$3.35
	Female M5	5431	GSF-HTN1-M5F	\$3.59

* 26mm Compressed

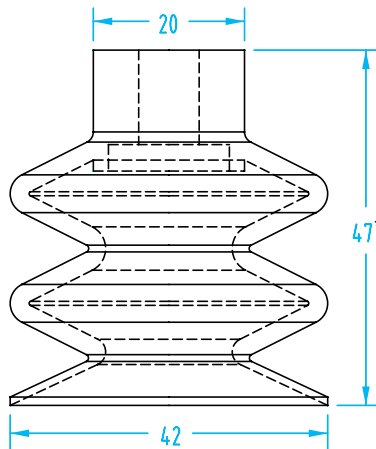
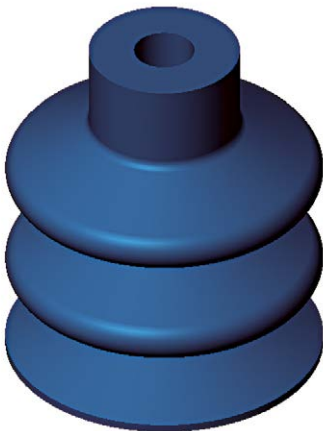

Cup Ø	Material	Quick#	Part#	Price
42mm	Hithane	1661	GSV-2BHT-42	\$12.35
Nipple	Female G1/8"	5432	GSF-HTN1-G8F	\$3.67
	Male G1/8"	5433	GSF-HTN1-G8M	\$3.67
	Female G1/4"	1744	GSF-HTN4-G4F	\$6.46
	Male G1/4"	1743	GSF-HTN4-G4M	\$6.45

Hithane® - Oval

(Shown Actual Size)



Hithane Vacuum Cup Properties

Material	Color	Max Temp.	Durometer
Hithane	Blue	320°F	55°

See page 212–213 for nipple dimensions.

Vacuum Cups

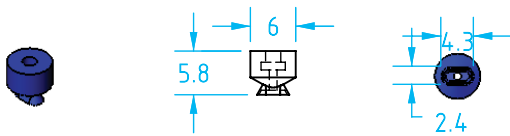

Cup Size	Material	Quick#	Part#	Price
2x4mm	Hithane	5416	GSV-OHT-24	\$9.50
Nipple	Male M3	3285	VSA5	\$5.80
	Female M5	5434	GSF-HTN2-M5FXS	\$3.59
	Male M5	5435	GSF-HTN2-M5MXS	\$3.59

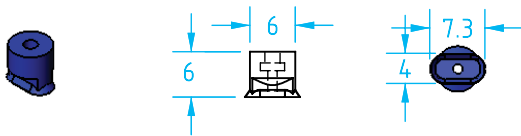

Cup Size	Material	Quick#	Part#	Price
3.5x7mm	Hithane	5417	GSV-OHT-357	\$9.64
Nipple	Male M3	3285	VSA5	\$5.80
	Female M5	5434	GSF-HTN2-M5FXS	\$3.59
	Male M5	5435	GSF-HTN2-M5MXS	\$3.59

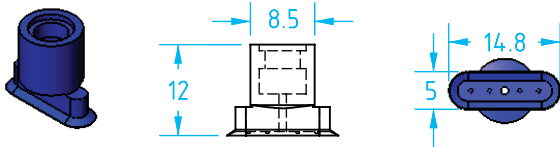

Cup Size	Material	Quick#	Part#	Price
5x15mm	Hithane	5418	GSV-OHT-515	\$18.64
Nipple	Male M5	378	GSF-N21-M5M	\$5.50
	Female M5	379	GSF-N21-M5F	\$5.50

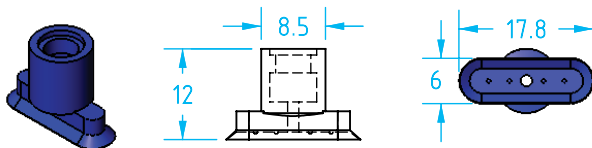

Cup Size	Material	Quick#	Part#	Price
6x18mm	Hithane	5419	GSV-OHT-618	\$19.58
Nipple	Male M5	378	GSF-N21-M5M	\$5.50
	Female M5	379	GSF-N21-M5F	\$5.50

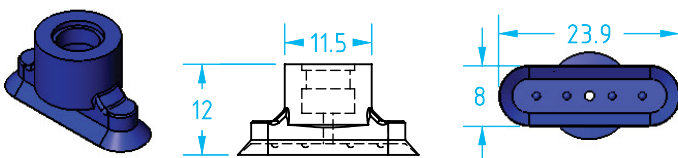

Cup Size	Material	Quick#	Part#	Price
8x24mm	Hithane	5420	GSV-OHT-824	\$22.14
Nipple	Female M5	5438	GSF-HTN2-M5FM	\$3.62
	Male M5	5439	GSF-HTN2-M5MM	\$3.62

Hithane® - Oval

(Shown Actual Size)

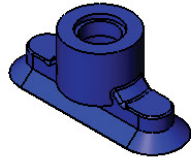

Cup Size	Material	Quick#	Part#	Price
10x30mm	Hithane	5421	GSV-OHT-1030	\$24.98
Nipple	Female M5	5438	GSF-HTN2-M5FM	\$3.62
	Male M5	5439	GSF-HTN2-M5MM	\$3.62

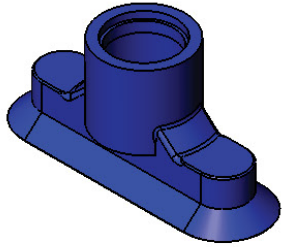
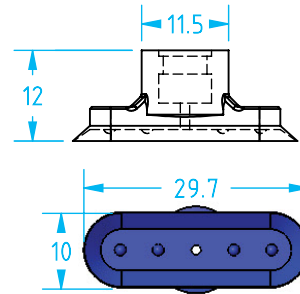

Cup Size	Material	Quick#	Part#	Price
15x45mm	Hithane	5422	GSV-OHT-1545	\$25.66
Nipple	Female G1/8"	5440	GSF-HTN2-G8FL	\$3.67
	Male G1/8"	5441	GSF-HTN2-G8ML	\$3.67

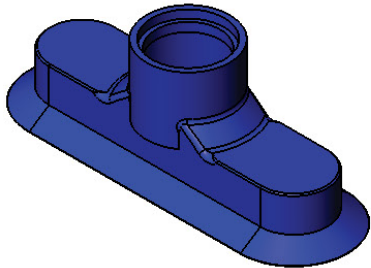
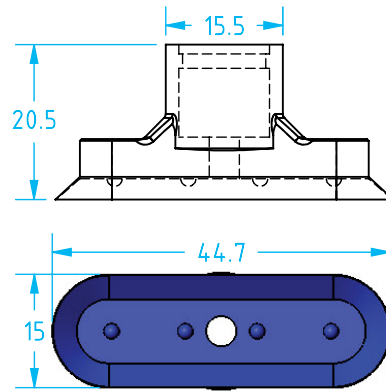

Cup Size	Material	Quick#	Part#	Price
20x60mm	Hithane	5423	GSV-OHT-2060	\$31.24
Nipple	Female G1/8"	5440	GSF-HTN2-G8FL	\$3.67
	Male G1/8"	5441	GSF-HTN2-G8ML	\$3.67

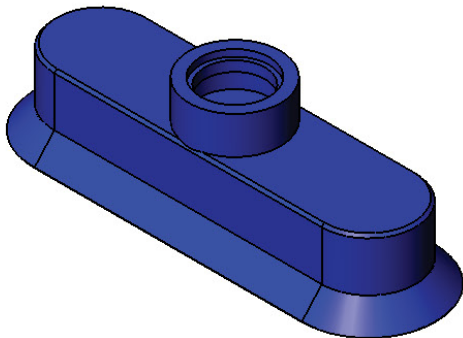
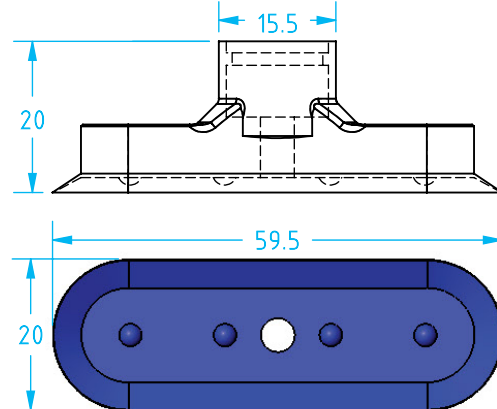

Cup Size	Material	Quick#	Part#	Price
25x75mm	Hithane	5424	GSV-OHT-2575	\$39.84
Nipple	Female G1/8"	5440	GSF-HTN2-G8FL	\$3.67
	Male G1/8"	5441	GSF-HTN2-G8ML	\$3.67

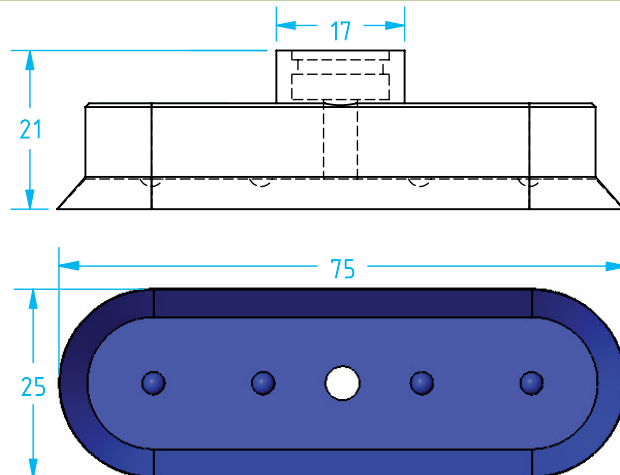

Hithane® - Vacuum Cup Nipples

(Shown Actual Size)

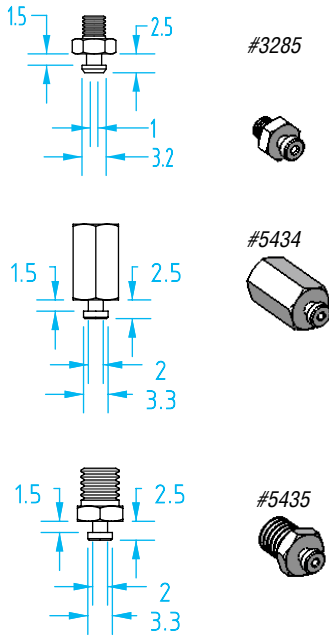

Thread	Quick#	Part#	Price
Male M3	3285	VSA5	\$5.80
Female M5	5434	GSF-HTN2-M5FX5	\$3.59
Male M5	5435	GSF-HTN2-M5MX5	\$3.59

For: Oval Cups: 2x4mm and 3.5x7mm

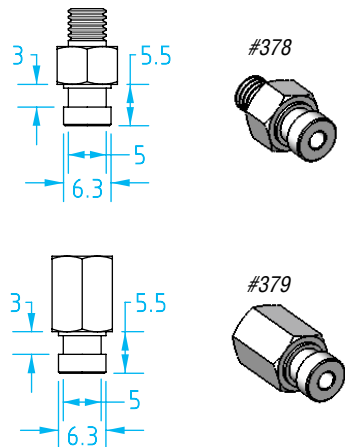

Thread	Quick#	Part#	Price
Male M5	378	GSF-N21-M5M	\$5.50
Female M5	379	GSF-N21-M5F	\$5.50

For: Oval Cups: 5x15mm and 6x18mm

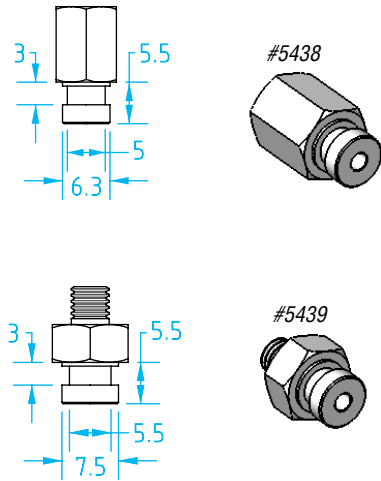

Thread	Quick#	Part#	Price
Female M5	5438	GSF-HTN2-M5FM	\$3.62
Male M5	5439	GSF-HTN2-M5MM	\$3.62

For: Oval Cups: 8x24mm and 10x30 mm

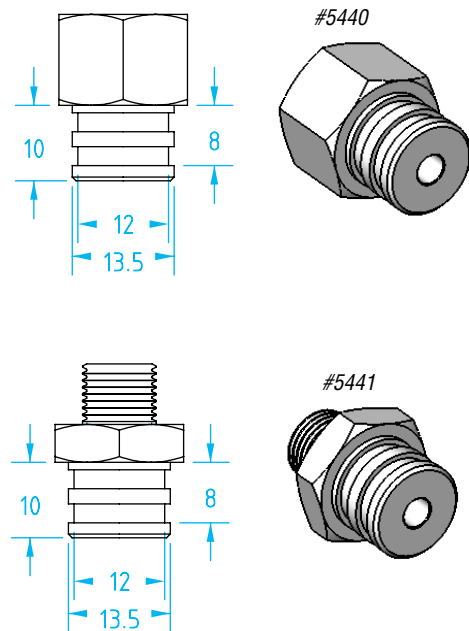

Thread	Quick#	Part#	Price
Female G1/8"	5440	GSF-HTN2-G8FL	\$3.90
Male G1/8"	5441	GSF-HTN2-G8ML	\$4.10

For: Oval Cups: 15x45mm, 20x60mm, and 25x75mm

Hithane® - Vacuum Cup Nipples

(Shown Actual Size)

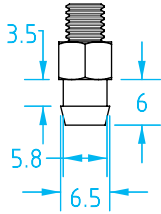

#408, nickle-plated, FDA approved

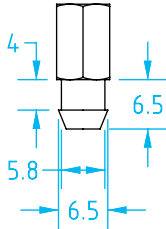

#5431



Thread	Quick#	Part#	Price
Female M5	5431	GSF-HTN1-M5F	\$3.59
Male M5	408	GSF-N16-M5M	\$3.35

For: Flat Cups: 5mm, 8mm, 11mm, 15mm, and 20mm
 1.5 Bellows Cups: 11mm, 14mm, 20mm, and 25mm
 2.5 Bellows Cups: 7mm, 9mm, 12mm, 14mm, 18mm, and 25mm

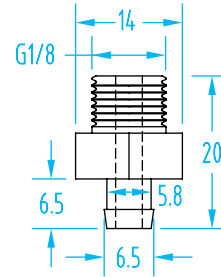

#1604

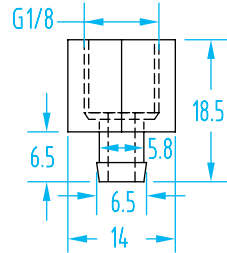

#1603



Thread	Quick#	Part#	Price
Male G1/8"	1604	GSF-PFN-G8M	\$3.80
Female G1/8"	1603	GSF-PFN-G8F	\$3.80

For: Flat Cups: 5mm, 8mm, 11mm, 15mm, and 20mm
 1.5 Bellows Cups: 14mm, 20mm, and 25mm
 2.5 Bellows Cups: 7mm, 9mm, 12mm, 14mm, 18mm, and 25mm

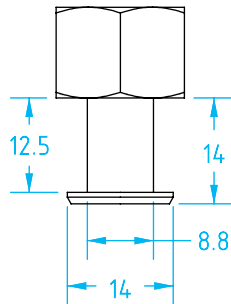

#5432

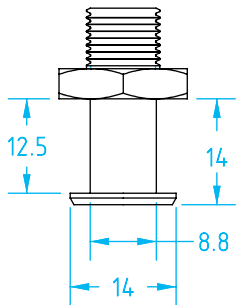
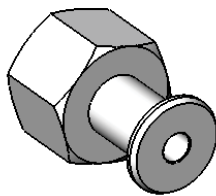

#5433

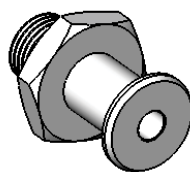

Thread	Quick#	Part#	Price
Female G1/8"	5432	GSF-HTN1-G8F	\$4.00
Male G1/8"	5433	GSF-HTN1-G8M	\$3.67

For: Flat Cups: 30mm, 40mm, and 50mm
 1.5 Bellows Cups: 33mm, 43mm, and 53mm
 2.5 Bellows Cups: 42mm

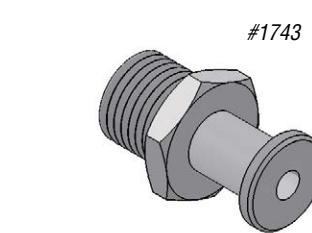

#1743

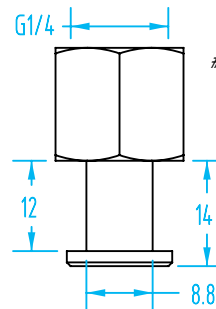
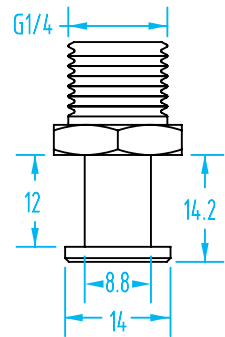

#1744

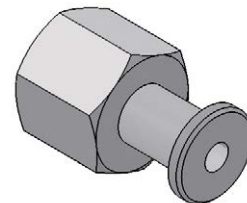

Thread	Quick#	Part#	Price
Male G1/4"	1743	GSF-HTN4-G4M	\$6.45
Female G1/4"	1744	GSF-HTN4-G4F	\$6.46

For: Flat Cups: 30mm, 40mm, and 50mm
 1.5 Bellows Cups: 33mm, 43mm, and 53mm
 2.5 Bellows Cups: 42mm

OEM Replacement - Flat Smooth

(Shown Actual Size)



Compatible with PIAB nipples!

OEM replacement vacuum cups are available in Hithane. This EMI exclusive material combines the high-temperature and flexibility properties of silicone with the wear resistance and non-marking properties of polyurethane.

OEM Replacement Vacuum Cup Properties

Material	Color	Max Temp.	Durometer
Silicone	Semi-translucent white	392°F	50°
Hithane	Blue	320°F	55°
Nitrile	Black	240°F	50°

Vacuum Cups

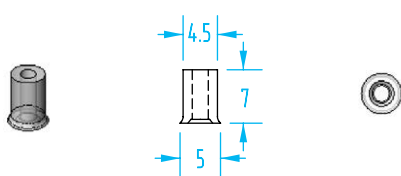

Cup Ø	Material	Quick#	Part#	Price
5mm	Silicone	673	GSV-FOS-5	\$2.10
	Hithane	1113	GSV-FOH-5	\$5.42
	Nitrile	1153	GSV-FON-5	\$1.85
Nipple	M5 Male	688	GSF-NF11-M5	\$2.20

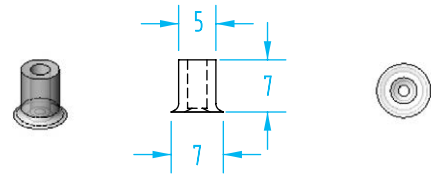

Cup Ø	Material	Quick#	Part#	Price
7mm	Silicone	674	GSV-FOS-7	\$2.39
	Hithane	1114	GSV-FOH-7	\$5.42
	Nitrile	1154	GSV-FON-7	\$1.85
Nipple	M5 Male	688	GSF-NF11-M5	\$2.20

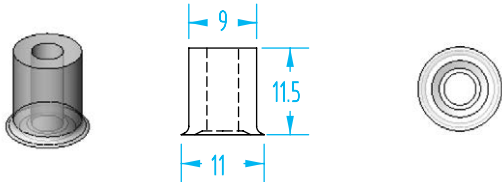

Cup Ø	Material	Quick#	Part#	Price
11mm	Silicone	675	GSV-FOS-11	\$3.19
	Hithane	1115	GSV-FOH-11	\$5.77
	Nitrile	1155	GSV-FON-11	\$2.02
Nipple	M5 Male	411	GSF-NF1-M5	\$1.67

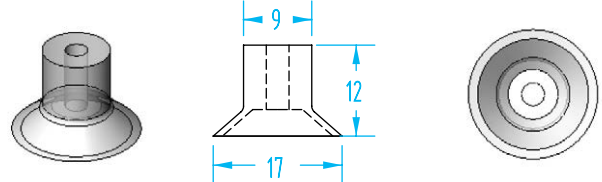

Cup Ø	Material	Quick#	Part#	Price
16mm	Silicone	676	GSV-FOS-16	\$3.51
	Hithane	1116	GSV-FOH-16	\$5.52
	Nitrile	1156	GSV-FON-16	\$2.13
Nipple	M5 Male	411	GSF-NF1-M5	\$1.67

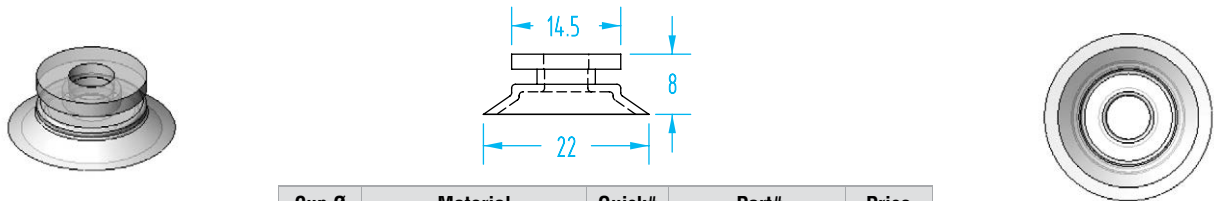

Cup Ø	Material	Quick#	Part#	Price
20mm	Silicone	677	GSV-FOS-20	\$3.22
	Hithane	1117	GSV-FOH-20	\$5.47
	Nitrile	1157	GSV-FON-20	\$2.78
Nipple	Male G1/8"/Female M5	412	GSF-NF2-G8M5	\$5.00

OEM Replacement - Flat Smooth

(Shown Actual Size)

Order nipples separately. See page 238–239 for nipple dimensions.

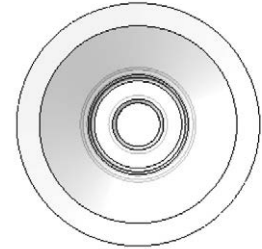
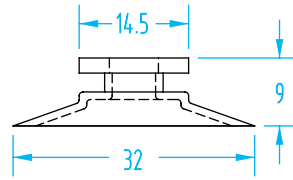
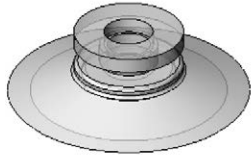

Cup Ø	Material	Quick#	Part#	Price
30mm	Silicone	679	GSV-FOS-30	\$5.07
	Hithane	1118	GSV-FOH-30	\$7.38
	Nitrile	1158	GSV-FON-30	\$3.29
Nipple	Male G1/8"/Female M5	412	GSF-NF2-G8M5	\$5.00

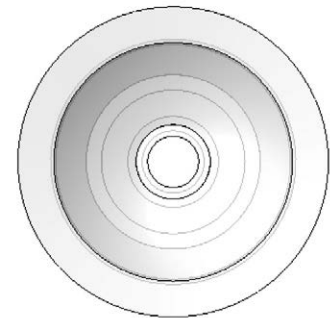
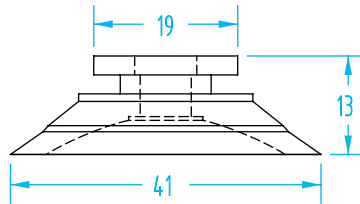
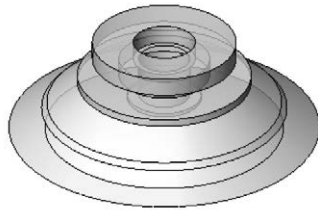

Cup Ø	Material	Quick#	Part#	Price
40mm	Silicone	680	GSV-FOS-40	\$5.31
	Hithane	1119	GSV-FOH-40	\$11.15
	Nitrile	1159	GSV-FON-40	\$4.56
Nipple	G1/8" Female	413	GSF-NF3-G8	\$6.25

Vacuum Cups

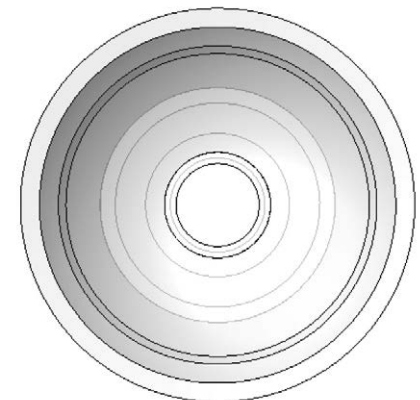
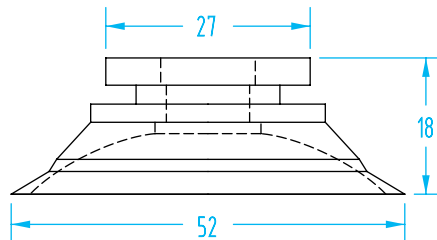
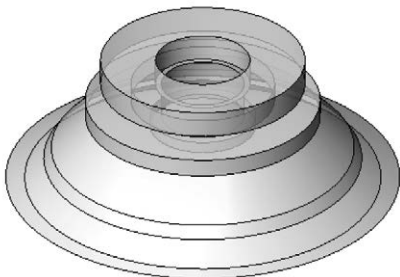

Cup Ø	Material	Quick#	Part#	Price
50mm	Silicone	681	GSV-FOS-50	\$6.76
	Hithane	1120	GSV-FOH-50	\$11.96
	Nitrile	1160	GSV-FON-50	\$5.37
Nipple	G1/8" Female	646	GSF-NF5-G8F	\$5.50

OEM Replacement - Flat Ribbed

(Shown Actual Size)

Compatible with PIAB nipples!

OEM replacement vacuum cups are available in Hithane. This EMI exclusive material combines the high-temperature and flexibility properties of silicone with the wear resistance and non-marking properties of polyurethane.

OEM Replacement Vacuum Cup Properties

Material	Color	Max Temp.	Durometer
Silicone	Semi-translucent White	392°F	50°
Hithane	Blue	320°F	55°
Nitrile	Black	240°F	50°

Order nipples separately. See page 238–239 for nipple dimensions.

Vacuum Cups

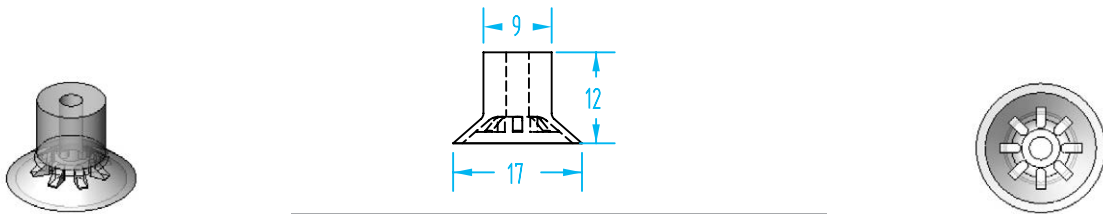

Cup Ø	Material	Quick#	Part#	Price
16mm	Silicone	682	GSV-FOS-16R	\$3.45
	Hithane	1122	GSV-FOH-16R	\$5.33
	Nitrile	1121	GSV-FON-16R	\$2.25
Nipple	M5 Male	411	GSF-NF1-M5	\$1.67

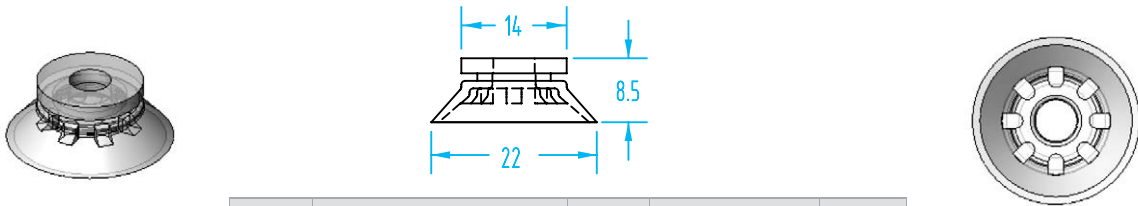

Cup Ø	Material	Quick#	Part#	Price
20mm	Silicone	683	GSV-FOS-20R	\$3.89
	Hithane	1124	GSV-FOH-20R	\$5.58
	Nitrile	1123	GSV-FON-20R	\$2.92
Nipple	Male G1/8"/Female M5	412	GSF-NF2-G8M5	\$5.00

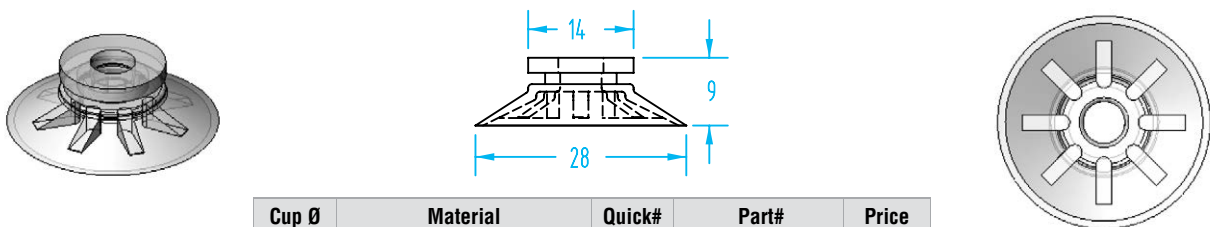

Cup Ø	Material	Quick#	Part#	Price
25mm	Silicone	684	GSV-FOS-25R	\$3.98
	Hithane	1126	GSV-FOH-25R	\$7.31
	Nitrile	1125	GSV-FON-25R	\$3.58
Nipple	Male G1/8"/Female M5	412	GSF-NF2-G8M5	\$5.00

OEM Replacement - Flat Ribbed

(Shown Actual Size)

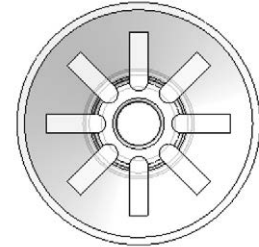
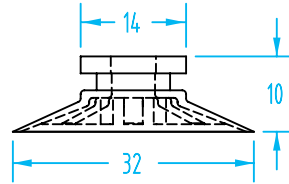
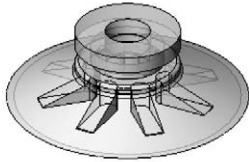

Cup Ø	Material	Quick#	Part#	Price
30mm	Silicone	685	GSV-FOS-30R	\$4.35
	Hithane	1128	GSV-FOH-30R	\$8.08
	Nitrile	1127	GSV-FON-30R	\$3.73
Nipple	Male G1/8"/Female M5	412	GSF-NF2-G8M5	\$5.00

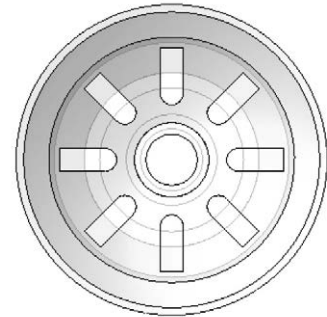
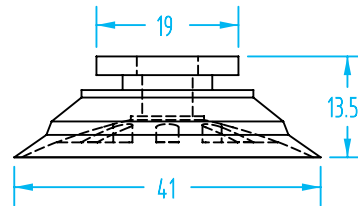
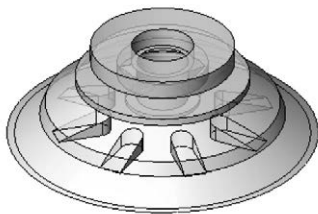

Cup Ø	Material	Quick#	Part#	Price
40mm	Silicone	686	GSV-FOS-40R	\$5.19
	Hithane	1130	GSV-FOH-40R	\$12.31
	Nitrile	1129	GSV-FON-40R	\$4.42
Nipple	G1/8" Female	413	GSF-NF3-G8	\$6.25

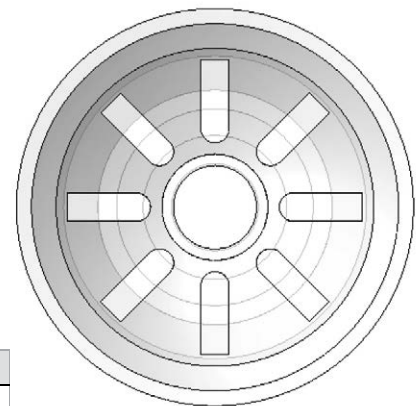
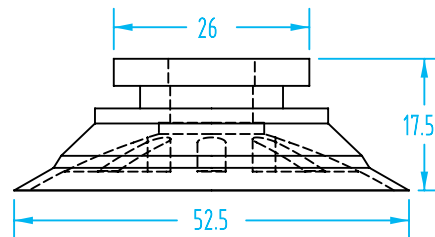
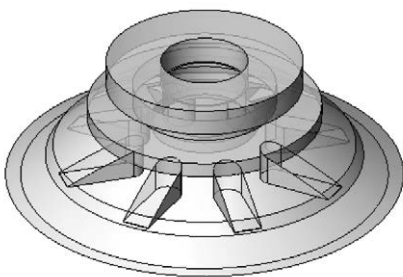

Cup Ø	Material	Quick#	Part#	Price
50mm	Silicone	687	GSV-FOS-50R	\$6.76
	Hithane	1132	GSV-FOH-50R	\$12.24
	Nitrile	1131	GSV-FON-50R	\$5.22
Nipple	G1/8" Female	646	GSF-NF5-G8F	\$5.50

Vacuum Cups

OEM Replacement - 1.5 Bellows

(Shown Actual Size)



Compatible with PIAB nipples!

OEM replacement vacuum cups are available in Hithane. This EMI exclusive material combines the high-temperature and flexibility properties of silicone with the wear resistance and non-marking properties of polyurethane.

OEM Replacement Vacuum Cup Properties

Material	Color	Max Temp.	Durometer
Silicone	Semi-translucent White	392°F	50°
Hithane	Blue	320°F	55°
Nitrile	Black	240°F	50°

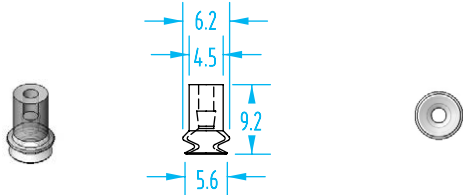

Cup Ø	Material	Quick#	Part#	Price
5mm	Silicone	1142	GSV-BOS-5	\$3.66
	Hithane	1133	GSV-BOH-5	\$6.69
	Nitrile	1144	GSV-BON-5	\$2.03
Nipple	M5 Male	688	GSF-NF11-M5	\$2.20

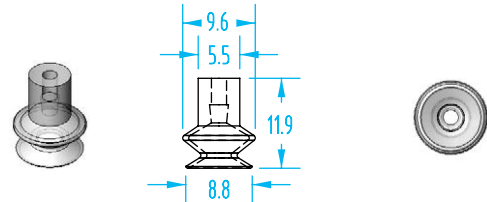

Cup Ø	Material	Quick#	Part#	Price
8mm	Silicone	1143	GSV-BOS-8	\$4.12
	Hithane	1134	GSV-BOH-8	\$6.35
	Nitrile	1145	GSV-BON-8	\$2.21
Nipple	M5 Male	688	GSF-NF11-M5	\$2.20

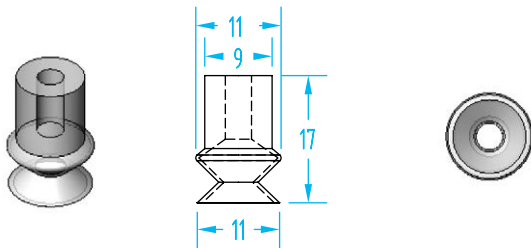

Cup Ø	Material	Quick#	Part#	Price
11mm	Silicone	640	GSV-BOS-11	\$2.22
	Hithane	1135	GSV-BOH-11	\$6.80
	Nitrile	1146	GSV-BON-11	\$2.47
Nipple	M5 Male	411	GSF-NF1-M5	\$1.67

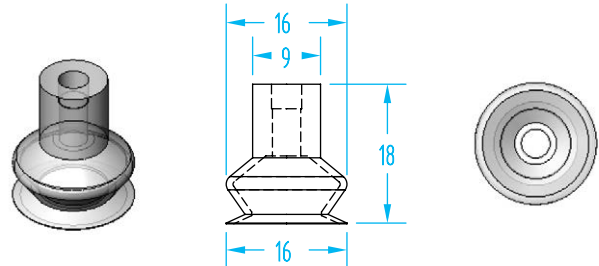

Cup Ø	Material	Quick#	Part#	Price
16mm	Silicone	641	GSV-BOS-16	\$2.88
	Hithane	1136	GSV-BOH-16	\$7.14
	Nitrile	1147	GSV-BON-16	\$2.62
Nipple	M5 Male	411	GSF-NF1-M5	\$1.67

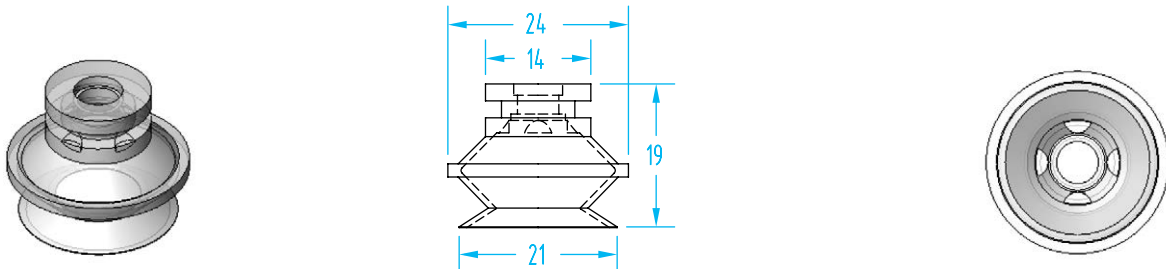

Cup Ø	Material	Quick#	Part#	Price
20mm	Silicone	642	GSV-BOS-20	\$6.30
	Hithane	1137	GSV-BOH-20	\$8.91
	Nitrile	1148	GSV-BON-20	\$4.16
Nipple	Male G1/8"/Female M5	412	GSF-NF2-G8M5	\$5.00

Vacuum Cups

OEM Replacement - 1.5 Bellows

(Shown Actual Size)

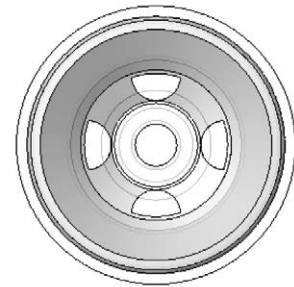
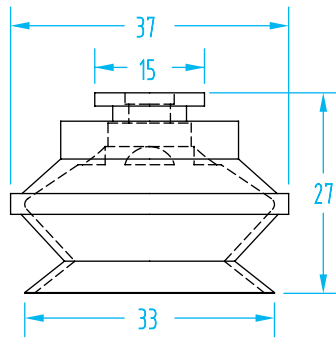

Cup Ø	Material	Quick#	Part#	Price
30mm	Silicone	643	GSV-BOS-30	\$9.07
	Hithane	1138	GSV-BOH-30	\$12.59
	Nitrile	1149	GSV-BON-30	\$5.27
Nipple	Male G1/8"/Female M5	412	GSF-NF2-G8M5	\$5.00

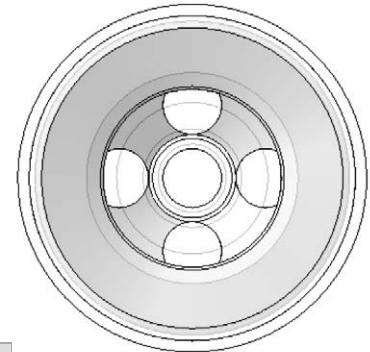
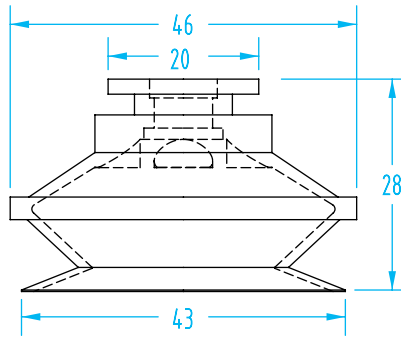
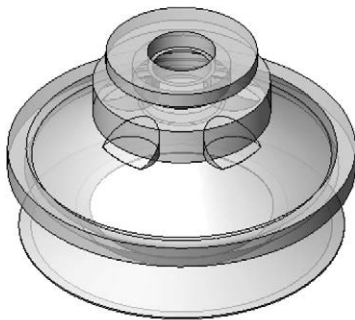

Cup Ø	Material	Quick#	Part#	Price
40mm	Silicone	644	GSV-BOS-40	\$10.56
	Hithane	1139	GSV-BOH-40	\$14.43
	Nitrile	1151	GSV-BON-40	\$6.73
Nipple	G1/8" Female	413	GSF-NF3-G8	\$6.25

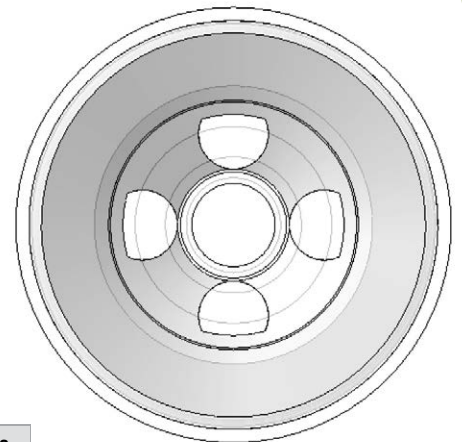
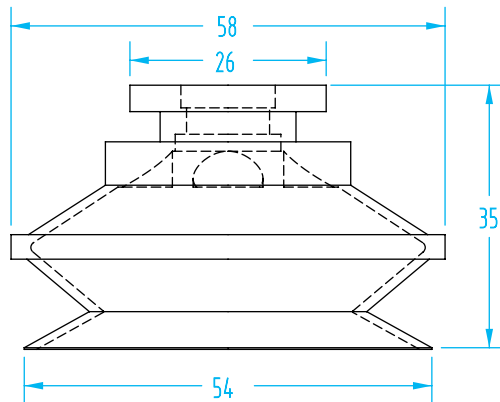
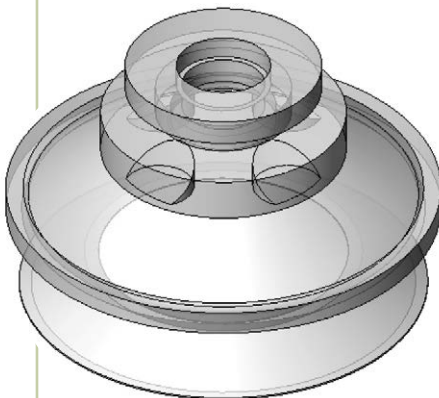

Cup Ø	Material	Quick#	Part#	Price
50mm	Silicone	645	GSV-BOS-50	\$12.22
	Hithane	1140	GSV-BOH-50	\$16.45
	Nitrile	1152	GSV-BON-50	\$8.02
Nipple	G1/8" Female	646	GSF-NF5-G8F	\$5.50

PIAB® - Flat Smooth



(Shown Actual Size)

PIAB silicone vacuum cups are among the best and longest lasting silicone cups available. PIAB's specially compounded silicone keeps its flexibility longer than others. If your silicone cups are 'cracking' at the edges and leaking vacuum, try these for longer life.

PIAB Vacuum Cup Properties

Material	Color	Max Temp.	Durometer
Silicone	Red	392°F	50°
Polyurethane TPU	Semi-Translucent White	176°F	81°
Chloroprene	Black	230°F	50°
Nitrile	Black w/ White Dot	225°F	50°

Order nipples separately. See page 238-239 for nipple dimensions.

When ordering, use Quick#s to ensure order accuracy

Vacuum Cups

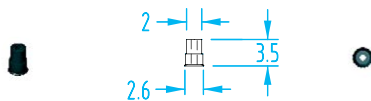

Cup Ø	Material	Quick#	Part#	Price
2mm	AS Silicone	5091	GSV-U2-25	\$8.35
Nipple	M3 Male	5464	GSF-MN15-M3	\$5.32

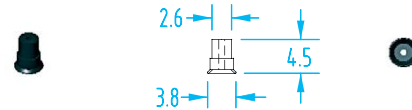

Cup Ø	Material	Quick#	Part#	Price
3mm	AS Silicone	5092	GSV-U3-25	\$8.95
Nipple	M3 Male	5464	GSF-MN15-M3	\$5.32

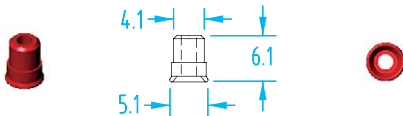

Cup Ø	Material	Quick#	Part#	Price
4mm	Silicone	5093	GSV-U4-20	\$6.15
	Chloroprene	5102	GSV-U4-10	\$2.63
Nipple	M5 Male	1438	GSV-01AB	\$1.76

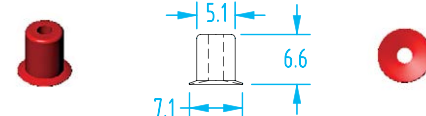

Cup Ø	Material	Quick#	Part#	Price
6mm	Silicone	5094	GSV-U6-20	\$4.70
	Chloroprene	5103	GSV-U6-10	\$2.30
Nipple	M5 Male	1438	GSV-01AB	\$1.76

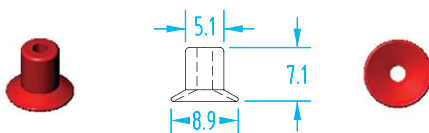

Cup Ø	Material	Quick#	Part#	Price
8mm	Silicone	5095	GSV-U8-20	\$5.08
	Chloroprene	5104	GSV-U8-10	\$2.30
Nipple	M5 Male	1438	GSV-01AB	\$1.76

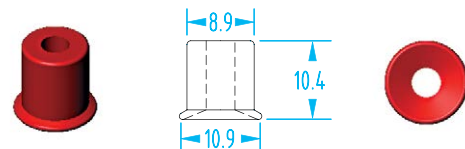

Cup Ø	Material	Quick#	Part#	Price
10mm	Silicone	5096	GSV-U10-20	\$4.98
	Chloroprene	5105	GSV-U10-10	\$2.58
Nipple	M5 Male	1439	GSV-01AC	\$1.76

PIAB® - Flat Smooth

(Shown Actual Size)

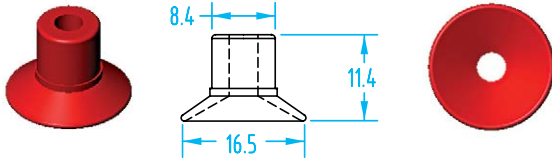

Cup Ø	Material	Quick#	Part#	Price
15mm	Silicone	5097	GSV-U15-20	\$4.98
	Chloroprene	5106	GSV-U15-10	\$2.91
Nipple	M5 Male	1439	GSV-01AC	\$1.76

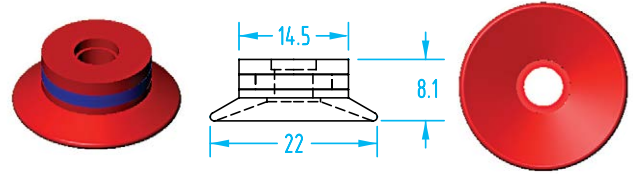

Cup Ø	Material	Quick#	Part#	Price
20mm	Silicone	5098	GSV-U20-20	\$6.64
	Chloroprene	5107	GSV-U20-10	\$4.83
Nipple	G1/8" & M5	1440	GSV-02AF	\$5.65
	G1/8" Male	5157	GSV-02AB	\$5.97

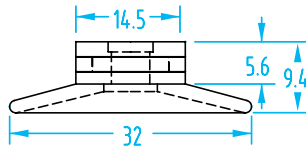

Cup Ø	Material	Quick#	Part#	Price
30mm	Silicone	5099	GSV-U30-20	\$7.30
	Nitrile	5108	GSV-U30-30	\$5.40
Nipple	G1/8" & M5	1440	GSV-02AF	\$5.65
	G1/8" Male	5157	GSV-02AB	\$5.97

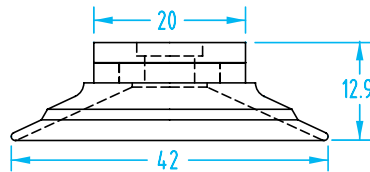

Cup Ø	Material	Quick#	Part#	Price
40mm	Silicone	5100	GSV-U40-2-20	\$12.41
	Nitrile	5109	GSV-U40-2-30	\$8.86
Nipple	G1/8" Female	1441	GSV-04AG	\$7.27

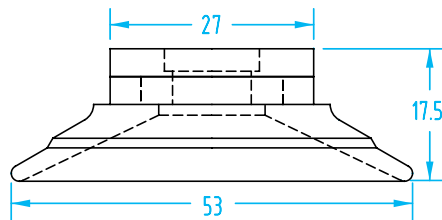

Cup Ø	Material	Quick#	Part#	Price
50mm	Silicone	5101	GSV-U50-2-20	\$15.76
	Nitrile	5110	GSV-U50-2-30	\$9.97
Nipple	G1/8" Female	1442	GSV-05AG	\$8.93



PIAB® - Flat Ribbed

(Shown Actual Size)



PIAB Vacuum Cup Properties

Material	Color	Max Temp.	Durometer
Silicone	Red	392°F	50°
Polyurethane TPU	Semi-Translucent White	176°F	81°
Chloroprene	Black	230°F	50°
Nitrile	Black w/ White Dot	225°F	50°

Order nipples separately. See page 238–239 for nipple dimensions.

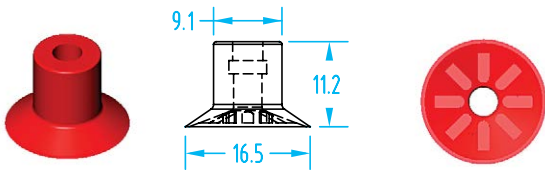

Cup Ø	Material	Quick#	Part#	Price
15mm	Silicone	1426	GSV-F15-20	\$4.35
	Polyurethane	1432	GSV-F15MF-40	\$2.79
	Chloroprene	5124	GSV-F15-10	\$2.58
Nipple	M5 Male	1439	GSV-01AC	\$1.76

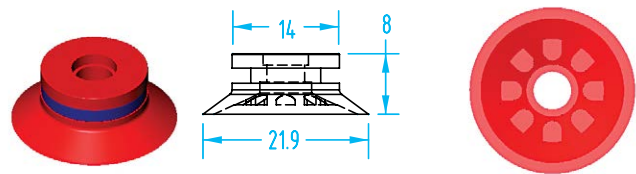

Cup Ø	Material	Quick#	Part#	Price
20mm	Silicone	1427	GSV-F20-20	\$6.37
	Polyurethane	1433	GSV-F20MF-40	\$4.92
	Chloroprene	5125	GSV-F20-10	\$4.77
Nipple	G1/8" & M5	1440	GSV-02AF	\$5.65
	G1/8" Male	5157	GSV-02AB	\$5.97

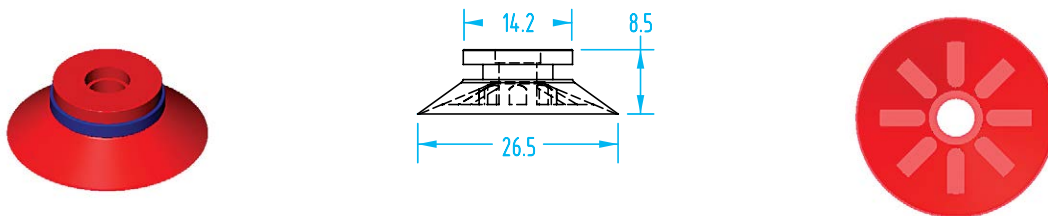

Cup Ø	Material	Quick#	Part#	Price
25mm	Silicone	1428	GSV-F25-20	\$6.78
	Polyurethane	1434	GSV-F25MF-40	\$5.08
	Chloroprene	5126	GSV-F25-10	\$5.27
Nipple	G1/8" & M5	1440	GSV-02AF	\$5.65
	G1/8" Male	5157	GSV-02AB	\$5.97

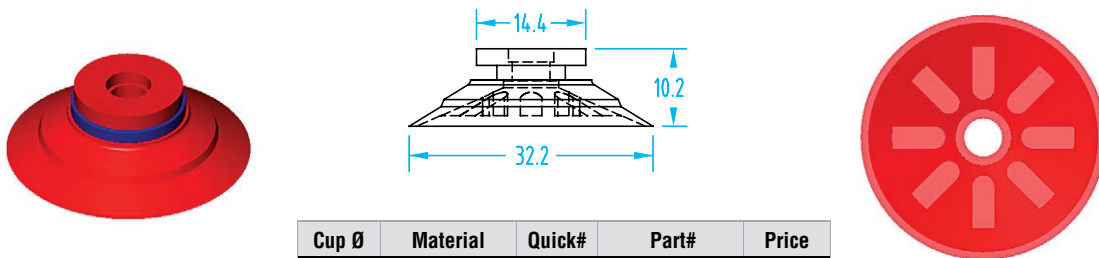

Cup Ø	Material	Quick#	Part#	Price
30mm	Silicone	1429	GSV-F30-20	\$7.14
	Polyurethane	1435	GSV-F30MF-40	\$5.58
	Chloroprene	5127	GSV-F30-10	\$5.41
Nipple	G1/8" & M5	1440	GSV-02AF	\$5.65
	G1/8" Male	5157	GSV-02AB	\$5.97

Vacuum Cups

PIAB® - Flat Ribbed

(Shown Actual Size)

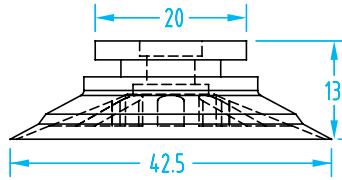

Cup Ø	Material	Quick#	Part#	Price
40mm	Silicone	1430	GSV-F40-20	\$9.80
	Polyurethane	1436	GSV-F40MF-40	\$6.83
	Nitrile	5128	GSV-F40-30	\$6.49
Nipple	G1/8" Female	1441	GSV-04AG	\$7.27

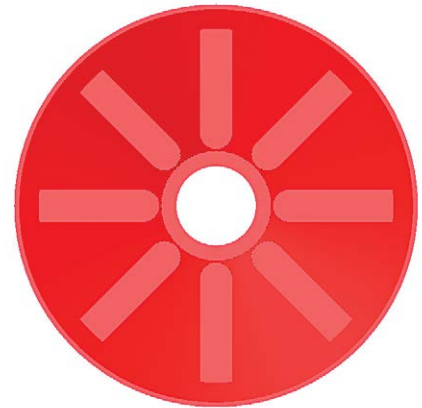
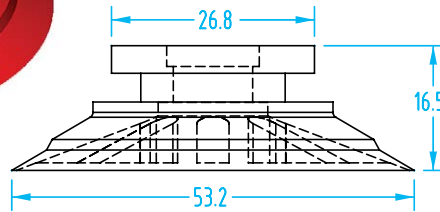

Cup Ø	Material	Quick#	Part#	Price
50mm	Silicone	1431	GSV-F50-20	\$15.65
	Polyurethane	1437	GSV-F50MF-40	\$7.85
	Nitrile	5129	GSV-F50-30	\$7.47
Nipple	G1/8" Female	1442	GSV-05AG	\$8.93

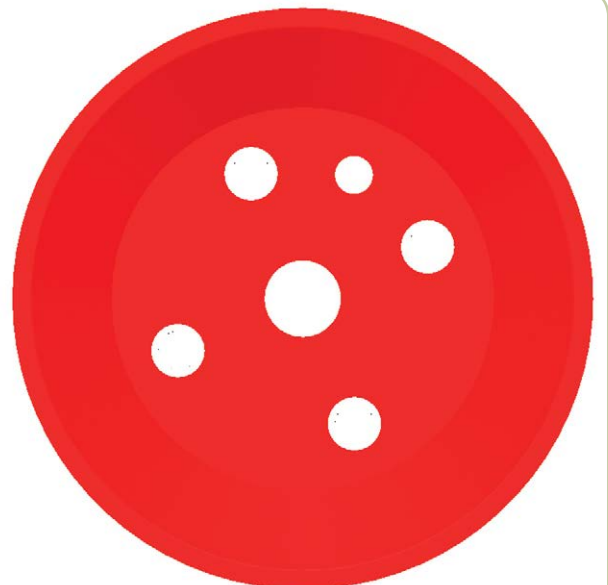
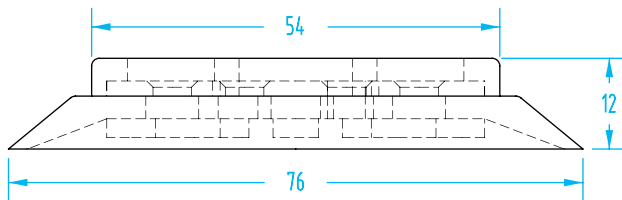

Cup Ø	Material	Quick#	Part#	Price
75mm	Silicone	5131	GSV-F75-20	\$22.68
	Nitrile	5130	GSV-F75-30	\$13.62
Nipple	G1/8" Female	2172	GSV-07UA	\$26.45

PIAB® - 1.5 Bellows



(Shown Actual Size)

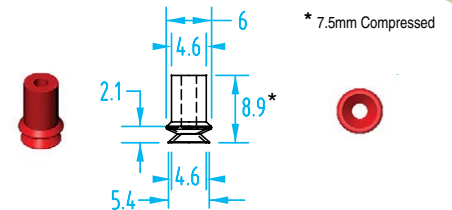

Cup Ø	Material	Quick#	Part#	Price
5mm	Silicone	1413	GSV-B5-20	\$6.59
	Chloroprene	5115	GSV-B5-10	\$2.49
Nipple	M5 Male	1438	GSV-01AB	\$1.76

Order nipples separately. See page 238–239 for nipple dimensions.

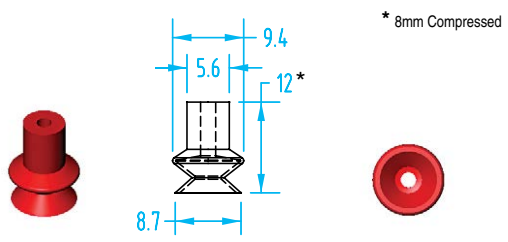

Cup Ø	Material	Quick#	Part#	Price
8mm	Silicone	1414	GSV-B8-20	\$7.70
	Chloroprene	5116	GSV-B8-10	\$2.90
Nipple	M5 Male	1438	GSV-01AB	\$1.76

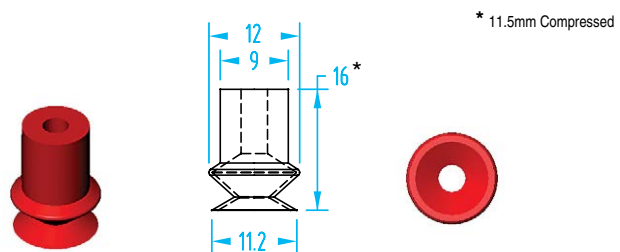

Cup Ø	Material	Quick#	Part#	Price
10mm	Silicone	1415	GSV-B10-2-20	\$6.77
	Chloroprene	5117	GSV-B10-2-10	\$3.60
Nipple	M5 Male	1439	GSV-01AC	\$1.76

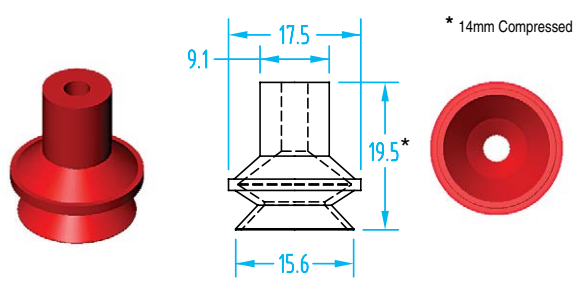

Cup Ø	Material	Quick#	Part#	Price
15mm	Silicone	1416	GSV-B15-2-20	\$8.23
	Polyurethane	1421	GSV-B15MF-40	\$3.89
	Chloroprene	5118	GSV-B15-2-10	\$3.60
Nipple	M5 Male	1439	GSV-01AC	\$1.76

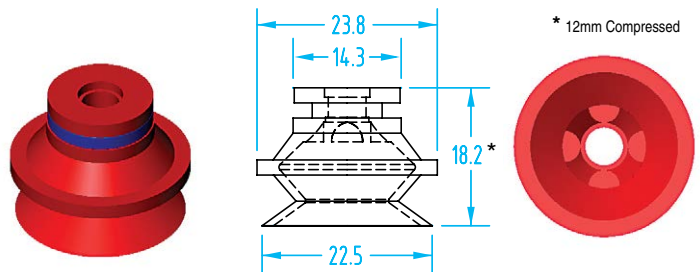

Cup Ø	Material	Quick#	Part#	Price
20mm	Silicone	1417	GSV-B20-20	\$11.09
	Polyurethane	1422	GSV-B20MF-40	\$6.18
	Chloroprene	5119	GSV-B20-10	\$6.00
Nipple	G1/8" & M5	1440	GSV-02AF	\$5.65

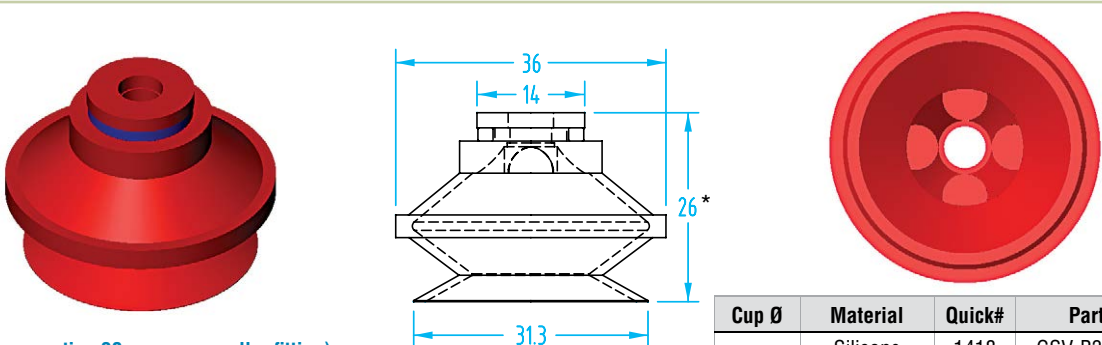

(1st generation 30mm cup—smaller fitting)

Cup Ø	Material	Quick#	Part#	Price
30mm	Silicone	1418	GSV-B30-20	\$16.08
	Chloroprene	5120	GSV-B30-10	\$8.42
Nipple	G1/8" & M5	1440	GSV-02AF	\$5.65
	G1/8" Male	5157	GSV-02AB	\$5.97

Vacuum Cups

PIAB® - 1.5 Bellows

(Shown Actual Size)

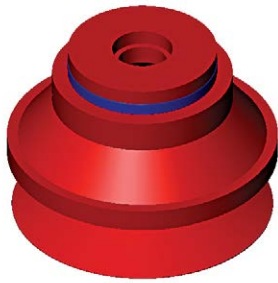

(2nd generation 30mm cup—larger fitting)

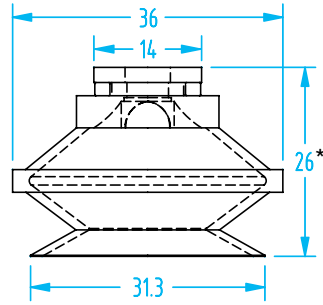

* 15mm Compressed

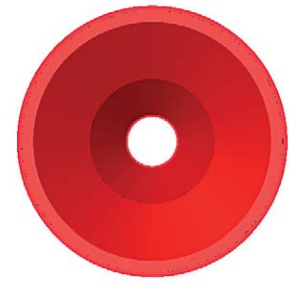

Cup Ø	Material	Quick#	Part#	Price
30mm	Silicone	2228	GSV-B30-2-20	\$16.08
	Polyurethane	1423	GSV-B30MF-40	\$8.43
	Chloroprene	5121	GSV-B30-2-10	\$8.42
Nipple	G1/8" Female	1441	GSV-04AG	\$7.27

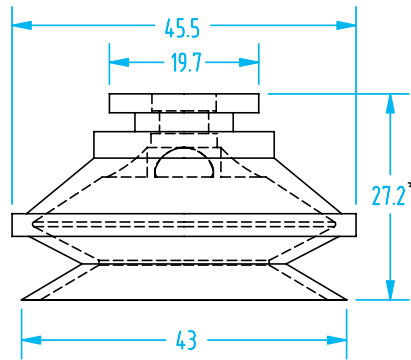

* 20mm Compressed

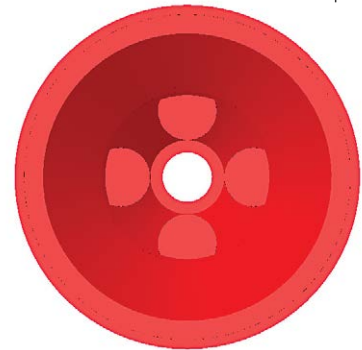

Cup Ø	Material	Quick#	Part#	Price
40mm	Silicone	1419	GSV-B40-20	\$18.90
	Polyurethane	1424	GSV-B40MF-40	\$10.56
	Chloroprene	5122	GSV-B40-10	\$10.53
Nipple	G1/8" Female	1441	GSV-04AG	\$7.27

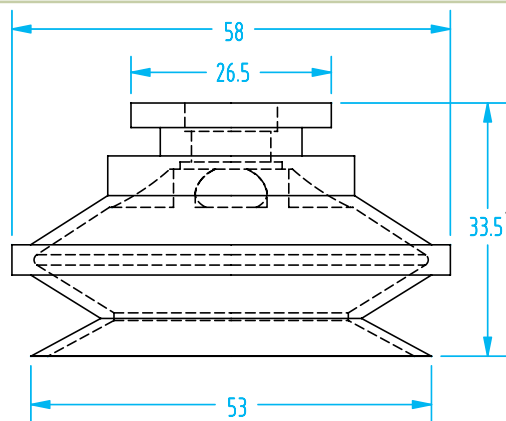
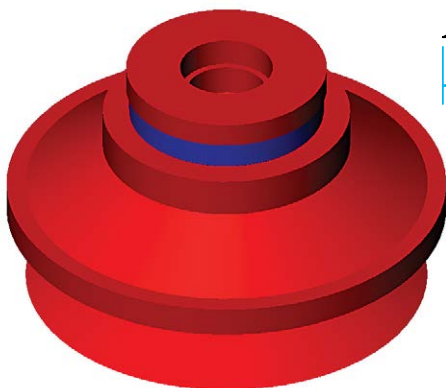

* 22mm Compressed

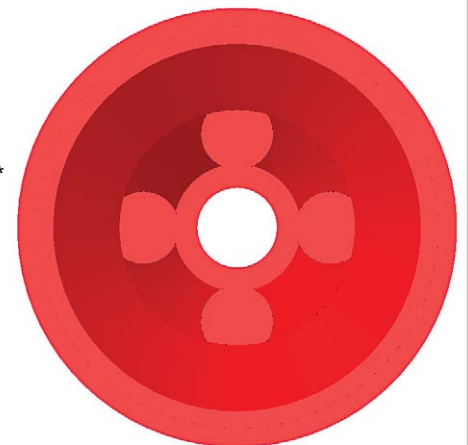

Cup Ø	Material	Quick#	Part#	Price
50mm	Silicone	1420	GSV-B50-20	\$21.74
	Polyurethane	1425	GSV-B50MF-40	\$12.14
	Nitrile	5123	GSV-B50-30	\$11.21
Nipple	G1/8" Female	1442	GSV-05AG	\$8.93

Also Available: 75mm Cup
 Q#2153 PIAB 1-1/2 Bellows
 Nitrile Vacuum Cup
 Q#1999 PIAB 1-1/2 Bellows
 Silicone Vacuum Cup

PIAB® - Deep

(Shown Actual Size)



PIAB Vacuum Cup Properties

Material	Color	Max Temp.	Durometer
Silicone	Red	392°F	50°
Polyurethane TPU	Semi-Translucent White	176°F	81°
Chloroprene	Black	230°F	50°
Nitrile	Black w/White Dot	225°F	50°

When ordering, use Quick#s to ensure order accuracy.

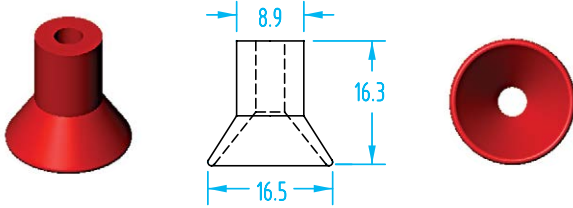

Cup Ø	Material	Quick#	Part#	Price
15mm	Silicone	5111	GSV-D15-2-20	\$5.58
	Chloroprene	5138	GSV-D15-2-10	\$3.29
Nipple	M5 Male	1439	GSV-01AC	\$1.76

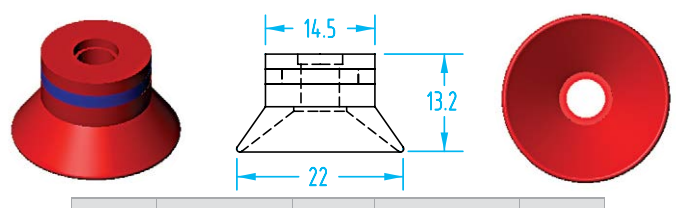

Cup Ø	Material	Quick#	Part#	Price
20mm	Silicone	5112	GSV-D20-2-20	\$7.38
	Chloroprene	5139	GSV-D20-2-10	\$4.73
Nipple	G1/8" & M5	1440	GSV-02AF	\$5.65
	G1/8" Male	5157	GSV-02AB	\$5.97

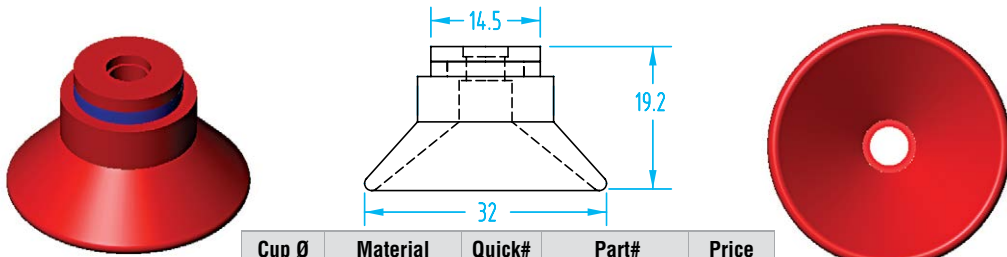

Cup Ø	Material	Quick#	Part#	Price
30mm	Silicone	5113	GSV-D30-2-20	\$9.04
	Chloroprene	5140	GSV-D30-2-10	\$6.38
Nipple	G1/8" & M5	1440	GSV-02AF	\$5.65
	G1/8" Male	5157	GSV-02AB	\$5.97

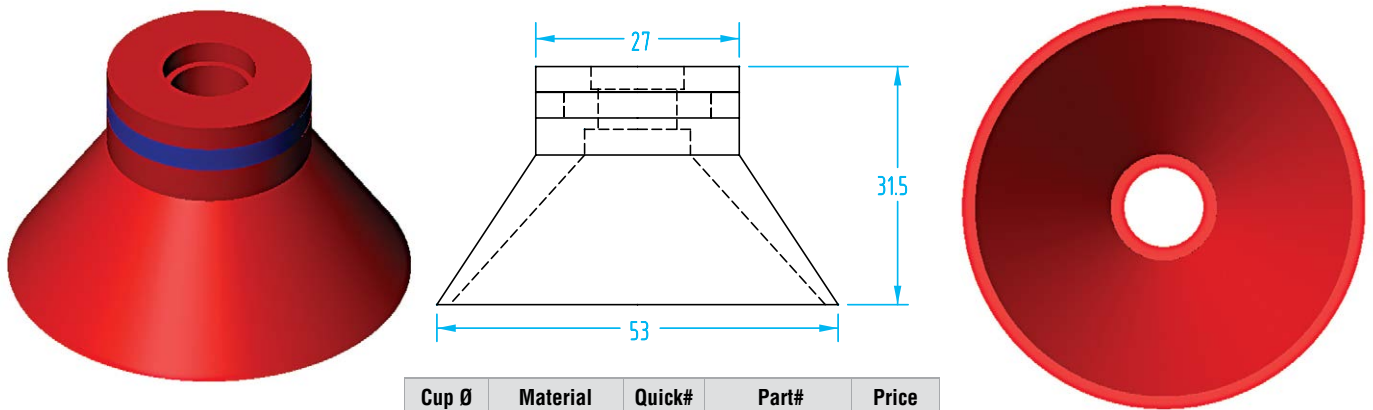

Cup Ø	Material	Quick#	Part#	Price
50mm	Silicone	5114	GSV-D50-20	\$17.57
	Chloroprene	5141	GSV-D50-10	\$10.11
Nipple	G1/8" Female	1442	GSV-05AG	\$8.93

Vacuum Cups

Quickly search over 700 Vacuum Cups with EMI's new website!

- Narrow your search by: cup diameter, style, material, and brand.
- Find dimensional drawings, technical specifications, and CAD file downloads.
- Corresponding nipples are listed on the page with vacuum cups.



www.EMInc.com

PIAB - Duraflex® Polyurethane with 2.5 Bellows

(Shown Actual Size)



Dual Durometer Polyurethane

These polyurethane vacuum cups are constructed in two different durometers (hardness). The cups have a sturdy and “forgiving” bellows (60° shore, green) and a large flexible sealing surface (30° shore, yellow) that performs extremely well on uneven surfaces. 30° shore makes these the most flexible sealing surface cups available. As shown installed in the cup on the left, white filter discs are included with 25mm and larger PIAB Dual Durometer cups.

The polyurethane makes them mark free and long lasting. The dual durometer makes these vacuum cups both strong and flexible.

Many consider these the best performing polyurethane cup available.

Dual Durometer Vacuum Cup Properties

Material	Color	Max Temp.	Durometer
Dual Durometer Polyurethane	Semi-translucent Green / Yellow	122°F	60° / 30° Shore

Order nipples separately. See page 238–239 for nipple dimensions.

Vacuum Cups

* 12.5mm Compressed

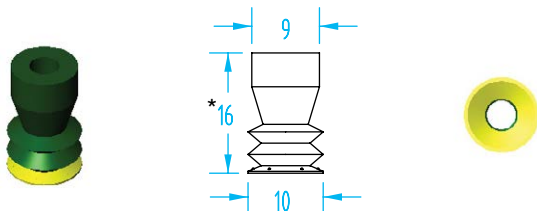

Cup Ø	Material	Quick#	Part#	Price
10mm	Polyurethane	5639	GSV-BDD-10	\$5.96
Nipple	M5 Male	1439	GSV-01AC	\$1.76

* 13.5mm Compressed

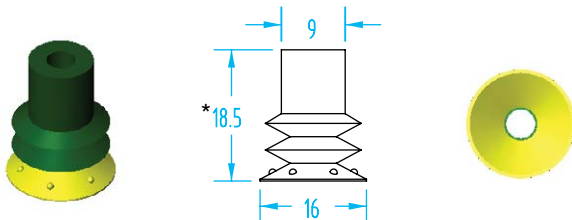

Cup Ø	Material	Quick#	Part#	Price
16mm	Polyurethane	5640	GSV-BDD-15	\$7.31
Nipple	M5 Male	1439	GSV-01AC	\$1.76

* 9mm Compressed

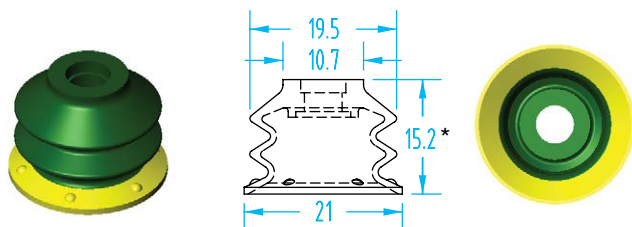

Cup Ø	Material	Quick#	Part#	Price
20mm	Polyurethane	5641	GSV-BDD-20	\$9.89
Nipple	G1/8" & M5	1440	GSV-02AF	\$5.65
	G1/8" Male	5157	GSV-02AB	\$5.97

PIAB - Duraflex® Polyurethane with 2.5 Bellows

(Shown Actual Size)

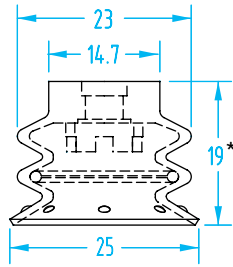

* 10mm Compressed

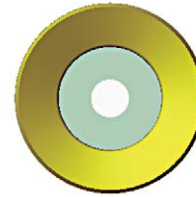

Includes filter disk

Cup Ø	Material	Quick#	Part#	Price
25mm	Polyurethane	5173	GSV-BDD-25	\$13.10
Nipple	G1/8" & M5	1440	GSV-02AF	\$5.65
	G1/8" Male	5157	GSV-02AB	\$5.97

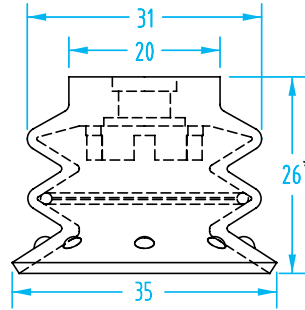
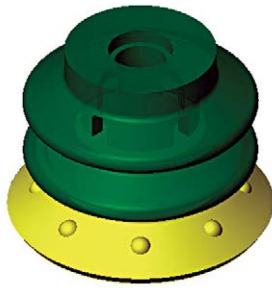

* 15mm Compressed

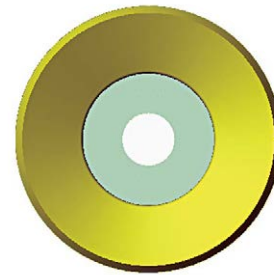

Includes filter disk

Cup Ø	Material	Quick#	Part#	Price
35mm	Polyurethane	1826	GSV-BDD-35	\$18.29
Nipple	G1/8" Female	1441	GSV-04AG	\$7.27
	G1/4" Male	5315	GSV-04AB	\$8.43

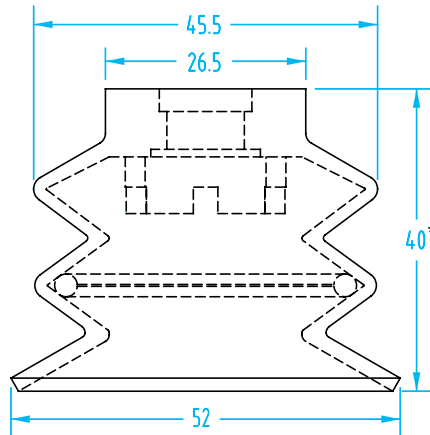
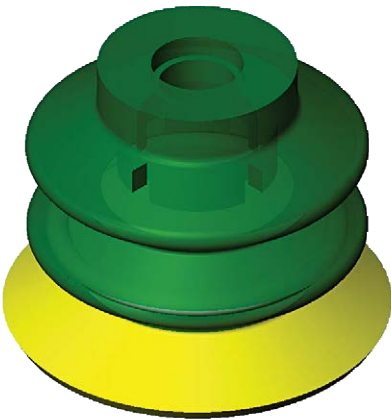

* 22mm Compressed

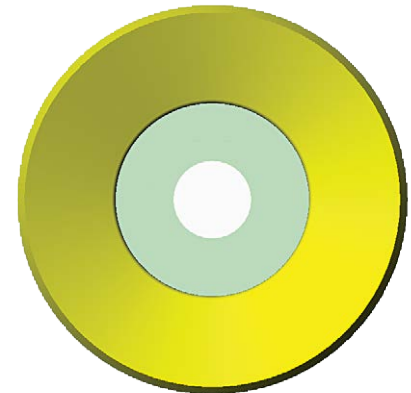

Includes filter disk

Cup Ø	Material	Quick#	Part#	Price
52mm	Polyurethane	1827	GSV-BDD-52	\$20.55
Nipple	G1/8" Female	1442	GSV-05AG	\$8.93
	G1/4" Male	5316	GSV-05AB	\$10.41

Cup Ø	Material	Quick#	Part#	Price
75mm	Polyurethane	5135	GSV-BX75P-4K-07UFF	\$37.23
Nipple	G3/8" Male / G1/8" Female			Included

* 36mm Compressed

Includes filter disk

PIAB - Duraflex® Polyurethane with 1.5 Bellows

(Shown Actual Size)



Dual Durometer Polyurethane

These polyurethane vacuum cups are constructed in two different durometers (hardness). The cups have a sturdy and “forgiving” bellows (60° shore, green) and a large flexible sealing surface (30° shore, yellow) that performs extremely well on uneven surfaces. 30° shore makes these the most flexible sealing surface cups available. As shown installed in the cup on the left, white filter discs are included with 25mm and larger PIAB Dual Durometer cups.

The polyurethane makes them mark free and long lasting. The dual durometer makes these vacuum cups both strong and flexible.

Many consider these the best performing polyurethane cup available.

Dual Durometer Vacuum Cup Properties

Material	Color	Max Temp.	Durometer
Dual Durometer Polyurethane	Semi-translucent Green / Yellow	122°F	60° / 30° Shore

Order nipples separately. See page 238–239 for nipple dimensions.

Vacuum Cups

* 10.8mm Compressed

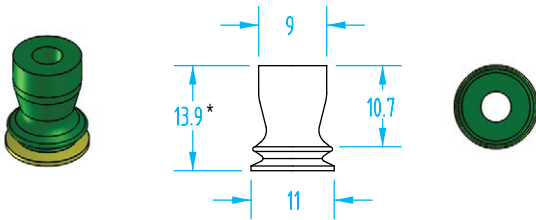

Cup Ø	Material	Quick#	Part#	Price
10mm	Polyurethane	5642	GSV-1BDD-10	\$5.92
Nipple	M5 Male	1439	GSV-01AC	\$1.76

* 11.5mm Compressed

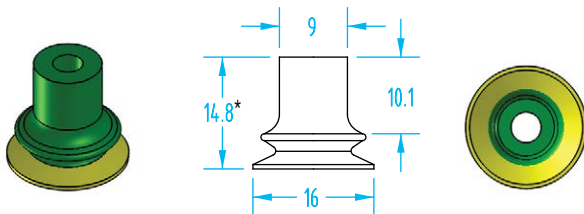

Cup Ø	Material	Quick#	Part#	Price
15mm	Polyurethane	5643	GSV-1BDD-15	\$7.26
Nipple	M5 Male	1439	GSV-01AC	\$1.76

* 5.8mm Compressed

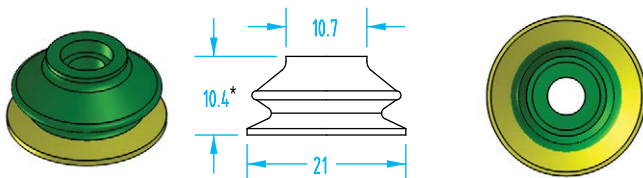

Cup Ø	Material	Quick#	Part#	Price
20mm	Polyurethane	5644	GSV-1BDD-20	\$10.27
Nipple	G1/8" & M5	1440	GSV-02AF	\$5.65
	G1/8" Male	5157	GSV-02AB	\$5.97

PIAB - Duraflex® Polyurethane with 1.5 Bellows

(Shown Actual Size)

* 7.9mm Compressed

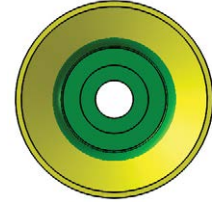
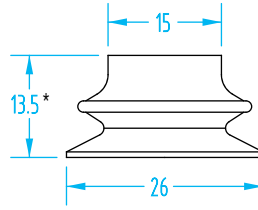
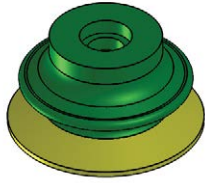

Cup Ø	Material	Quick#	Part#	Price
25mm	Polyurethane	5645	GSV-1BDD-25	\$11.44
Nipple	G1/8" & M5	1440	GSV-02AF	\$5.65
	G1/8" Male	5157	GSV-02AB	\$5.97

* 9.2mm Compressed

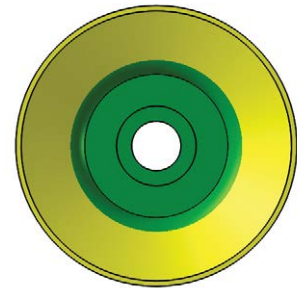
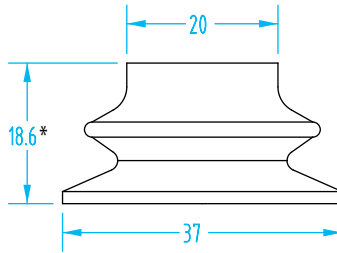
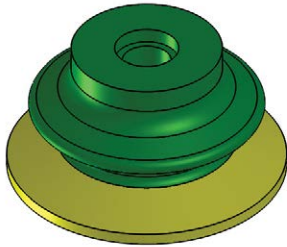

Cup Ø	Material	Quick#	Part#	Price
35mm	Polyurethane	5646	GSV-1BDD-35	\$16.56
Nipple	G1/8" Female	1441	GSV-04AG	\$7.27
	G1/4" Male	5315	GSV-04AB	\$8.43

* 15.8mm Compressed

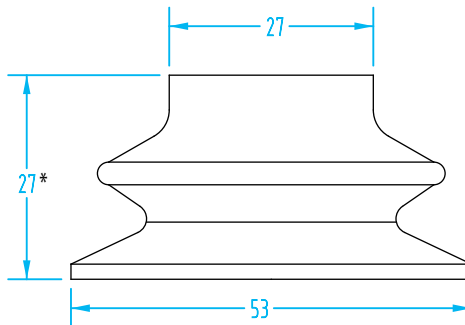
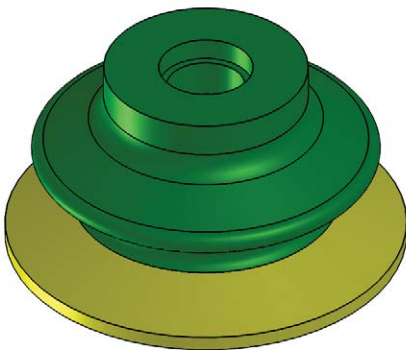

Cup Ø	Material	Quick#	Part#	Price
52mm	Polyurethane	5647	GSV-1BDD-52	\$19.44
Nipple	G1/8" Female	1442	GSV-05AG	\$8.93
	G1/4" Male	5316	GSV-05AB	\$10.41

* 36mm Compressed

Cup Ø	Material	Quick#	Part#	Price
75mm	Polyurethane	5648	GSV-1BDD-75	\$33.84
Nipple	G3/8" Male / G1/8" Female			Included

ShorTec™ Dual Durometer with Large Lip – 2.5 Bellows

(Shown Actual Size)



New Dual Durometer Vacuum Cups, now with a larger and more flexible lip!

Dual durometer-style vacuum cups are considered to be the best performing polyurethane cup.

These new yellow dual durometer cups are comparable to our current cups on page 234–235 but with larger and more flexible lips. They use mark-free and long-lasting polyurethane, and fit the same size nipples. The yellow bellows have a 55° shore and a large, flexible sealing surface with a lighter blue 30° shore.

Vacuum Cup Properties

Material	Color	Max Temp.	Durometer
Polyurethane	Yellow / Blue	122°F	30° / 55° Shore

Vacuum Cups

* 7.7mm Compressed

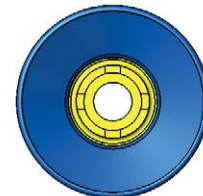
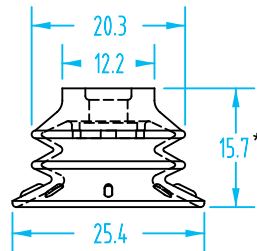

Cup Ø	Material	Quick#	Part#	Price
25mm	Polyurethane	2066	25B-DDBC-25	\$9.20
Nipple	G1/8" Male	5982	F02-G8M	\$2.88
	G1/8" Female	5983	F02-G8F	\$2.88

* 11.5mm Compressed

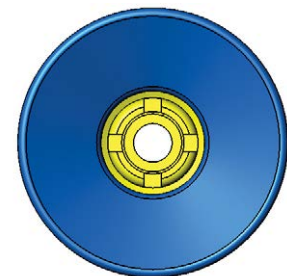
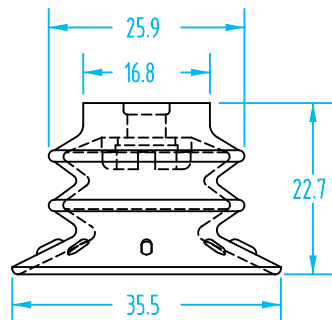
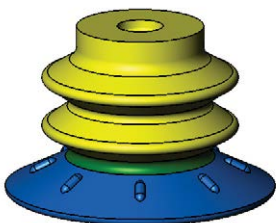

Cup Ø	Material	Quick#	Part#	Price
35mm	Polyurethane	2067	25B-DDBL-35	\$12.10
Nipple	G1/8" Male	5982	F02-G8M	\$2.88
	G1/8" Female	5983	F02-G8F	\$2.88

ShorTec™ Dual Durometer with Large Lip – 2.5 Bellows

(Shown Actual Size)

Order nipples separately. See page 238–239 for nipple dimensions.

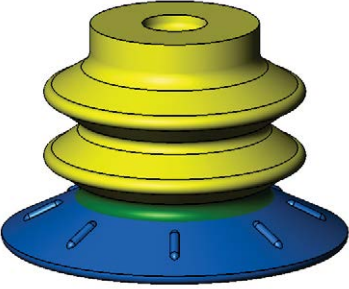
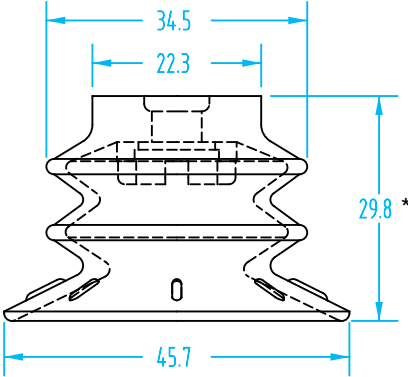
* 15mm Compressed



Cup Ø	Material	Quick#	Part#	Price
45mm	Polyurethane	2068	25B-DDBL-45	\$14.20
Nipple	G1/4" Male	5984	F03-G4M	\$3.58
	G1/4" Female	5985	F03-G4F	\$3.58

* 18mm Compressed

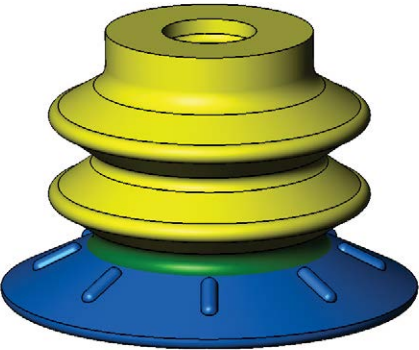
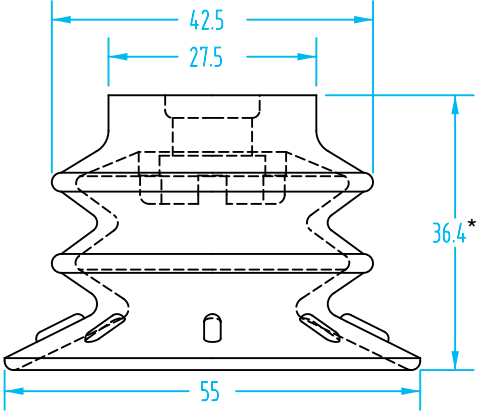

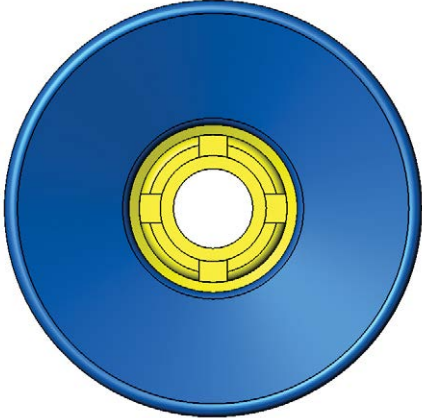
Cup Ø	Material	Quick#	Part#	Price
55mm	Polyurethane	2069	25B-DDBL-55	\$16.30
Nipple	G3/8" Male	5986	F04-G3M	\$3.92
	G3/8" Female	5987	F04-G3F	\$3.92

ShorTec™ Dual Durometer – 2.5 Bellows

(Shown Actual Size)



Dual Durometer Vacuum Cups!

Dual durometer-style vacuum cups are considered to be the best performing polyurethane cup and are now available at a lower price.

These blue dual durometer cups are comparable to the brand-name OEM green and yellow cups in that they use mark-free and long-lasting polyurethane, have the same dual-shore rating, and fit the same size nipples. They have a sturdy dark blue bellows with a 60° shore and a large, flexible sealing surface with a lighter blue 30° shore.

Vacuum Cup Properties

Material	Color	Max Temp.	Durometer
Polyurethane	Blue / Blue	122°F	60° / 30° Shore

Order nipples separately. See page 238–239 for nipple dimensions.

Vacuum Cups

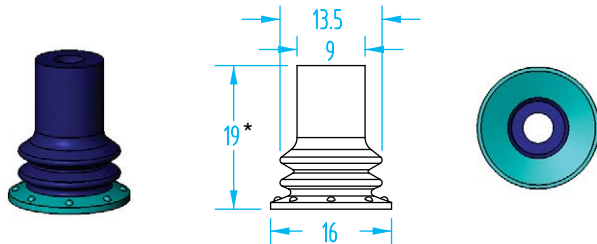

* 14mm Compressed

Cup Ø	Material	Quick#	Part#	Price
15mm	Polyurethane	5967	25B-DD-15	\$5.36
Nipple	M5 Male	411	GSF-NF1-M5	\$1.67

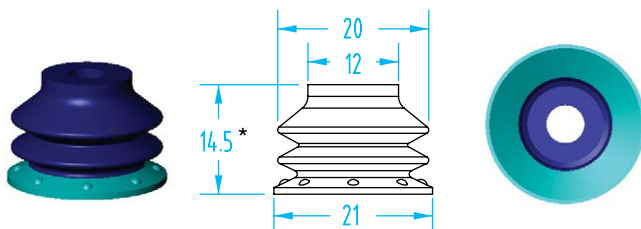

* 9mm Compressed

Cup Ø	Material	Quick#	Part#	Price
20mm	Polyurethane	5971	25B-DD-20	\$7.45
Nipple	G1/8" Male	5982	F02-G8M	\$2.88
	G1/8" Female	5983	F02-G8F	\$2.88

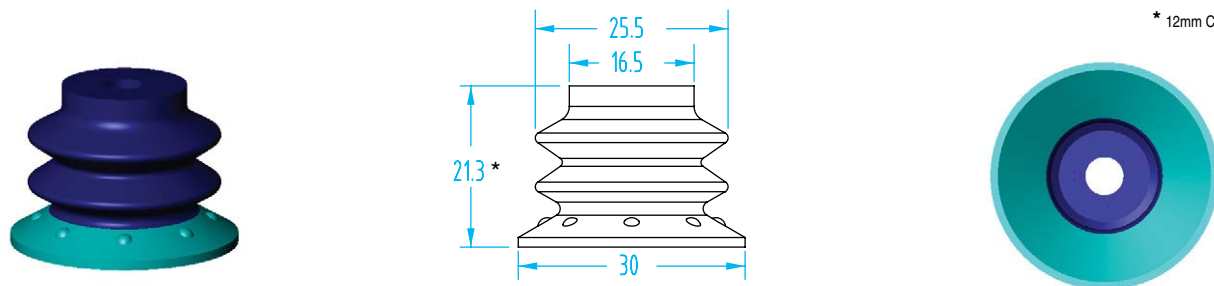

* 12mm Compressed

Cup Ø	Material	Quick#	Part#	Price
30mm	Polyurethane	5972	25B-DD-30	\$9.83
Nipple	G1/4" Male	5984	F03-G4M	\$3.58
	G1/4" Female	5985	F03-G4F	\$3.58

ShorTec™ Dual Durometer – 2.5 Bellows

(Shown Actual Size)

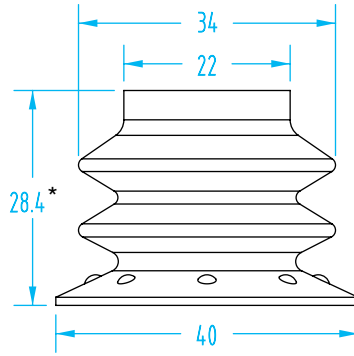

* 16mm Compressed



Cup Ø	Material	Quick#	Part#	Price
40mm	Polyurethane	5973	25B-DD-40	\$13.28
Nipple	G1/4" Male	5984	F03-G4M	\$3.58
	G1/4" Female	5985	F03-G4F	\$3.58

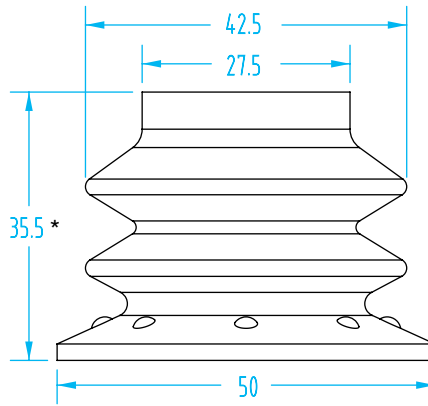

* 20mm Compressed



G3/8" to G1/4" reducer fittings are available on catalog page 959.

Cup Ø	Material	Quick#	Part#	Price
50mm	Polyurethane	5974	25B-DD-50	\$15.81
Nipple	G3/8" Male	5986	F04-G3M	\$3.92
	G3/8" Female	5987	F04-G3F	\$3.92

Vacuum Cups

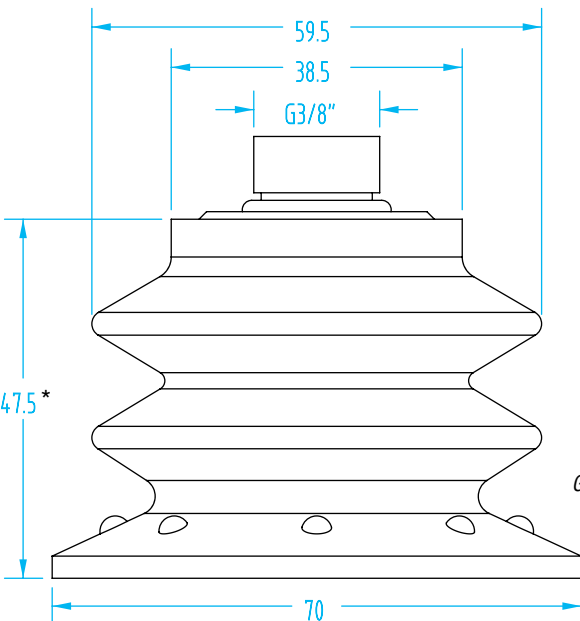

* 23mm Compressed

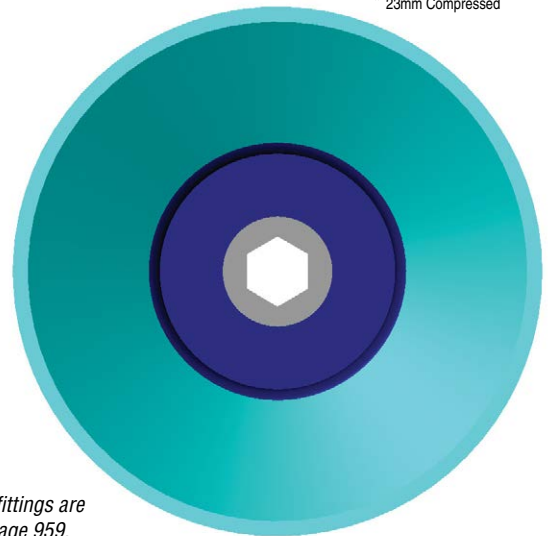

G3/8" to G1/4" reducer fittings are available on catalog page 959.

Cup Ø	Material	Quick#	Part#	Price
70mm	Polyurethane	5975	25B-DD-70	\$26.15
Note: G3/8" Male Nipple Included				

ShorTec™ Dual Durometer – 1.5 Bellows

(Shown Actual Size)



New Dual Durometer Vacuum Cups!

Dual durometer-style vacuum cups are considered to be the best performing polyurethane cup and are now available at a lower price.

These blue dual durometer cups are comparable to the brand-name OEM green and yellow cups in that they use mark-free and long-lasting polyurethane, have the same dual-shore rating, and fit the same size nipples. They have a sturdy dark blue bellows with a 60° shore and a large, flexible sealing surface with a lighter blue 30° shore.

Vacuum Cup Properties

Material	Color	Max Temp.	Durometer
Polyurethane	Blue / Blue	122°F	60° / 30° Shore

Order nipples separately. See page 238–239 for nipple dimensions.

Vacuum Cups

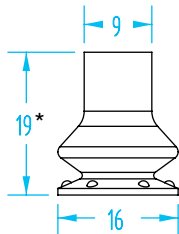

* 15mm Compressed

Cup Ø	Material	Quick#	Part#	Price
15mm	Polyurethane	5976	15B-DD-15	\$4.24
Nipple	M5 Male	411	GSF-NF1-M5	\$1.67

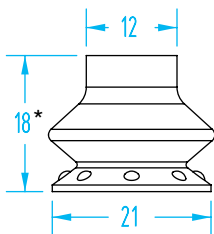

* 12mm Compressed

Cup Ø	Material	Quick#	Part#	Price
20mm	Polyurethane	5977	15B-DD-20	\$4.90
Nipple	G1/8" Male	5982	F02-G8M	\$2.88
	G1/8" Female	5983	F02-G8F	\$2.88

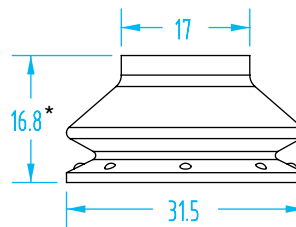

* 11.5mm Compressed

Cup Ø	Material	Quick#	Part#	Price
30mm	Polyurethane	5978	15B-DD-30	\$6.94
Nipple	G1/4" Male	5984	F03-G4M	\$3.58
	G1/4" Female	5985	F03-G4F	\$3.58

ShorTec™ Dual Durometer – 1.5 Bellows

(Shown Actual Size)

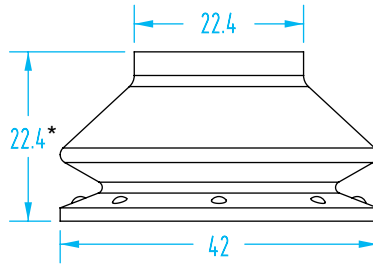

* 16mm Compressed

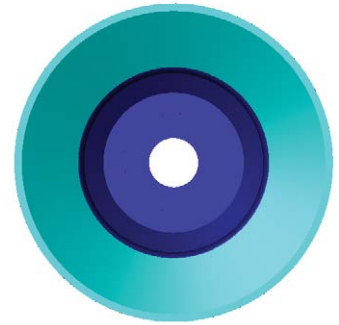

Cup Ø	Material	Quick#	Part#	Price
40mm	Polyurethane	5979	15B-DD-40	\$9.25
Nipple	G1/4" Male	5984	F03-G4M	\$3.58
	G1/4" Female	5985	F03-G4F	\$3.58

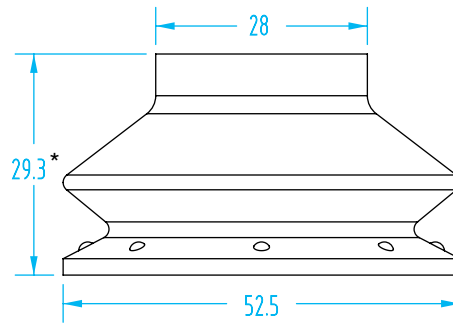

* 21mm Compressed

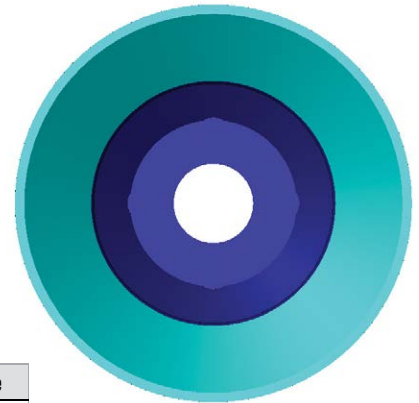

G3/8" to G1/4" reducer fittings are available on catalog page 959.

Cup Ø	Material	Quick#	Part#	Price
50mm	Polyurethane	5980	15B-DD-50	\$10.89
Nipple	G3/8" Male	5986	F04-G3M	\$3.92
	G3/8" Female	5987	F04-G3F	\$3.92

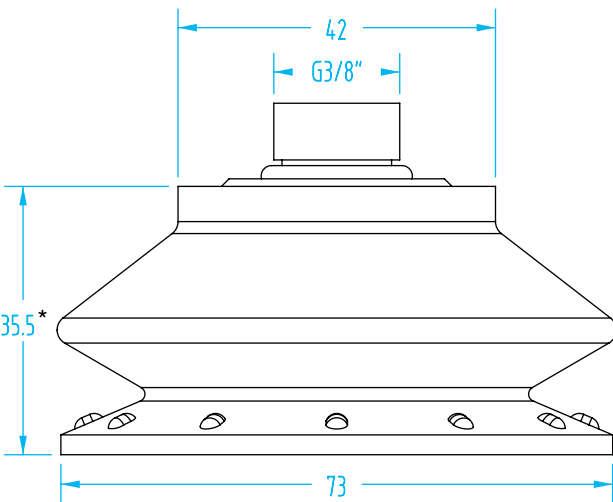

* 24mm Compressed

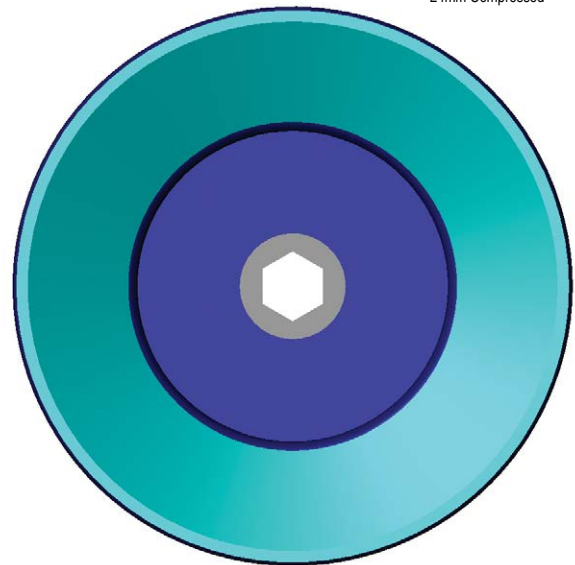

G3/8" to G1/4" reducer fittings are available on catalog page 959.

Cup Ø	Material	Quick#	Part#	Price
70mm	Polyurethane	5981	15B-DD-70	\$22.59
Note: G3/8" Male Nipple Included				

OEM, ShorTec & PIAB - Nipples

(Shown Actual Size)

M3

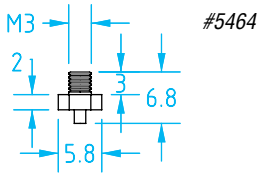

M5

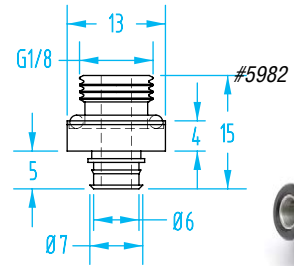
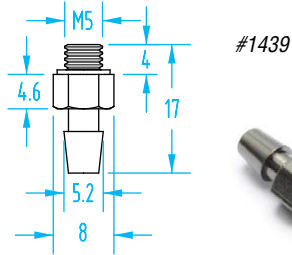
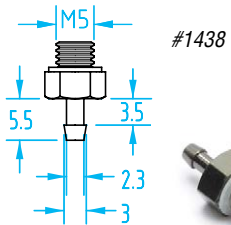
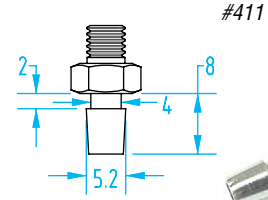
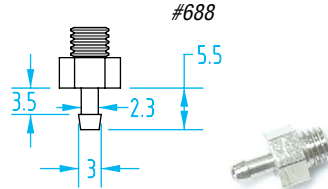

M5 Female / G1/8" Male

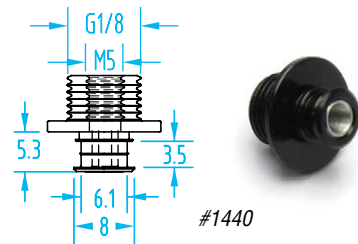
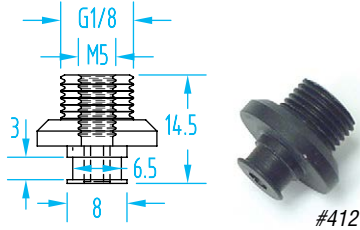

Vacuum Cups

G1/8"

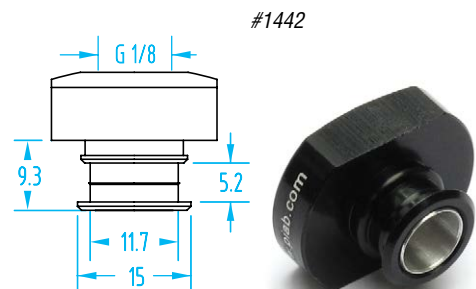
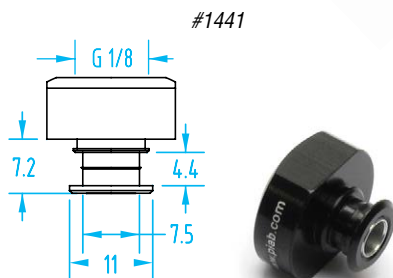
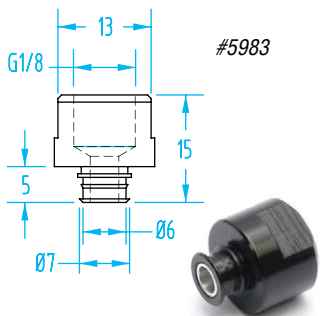
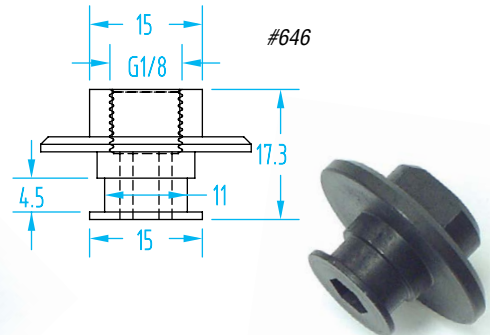
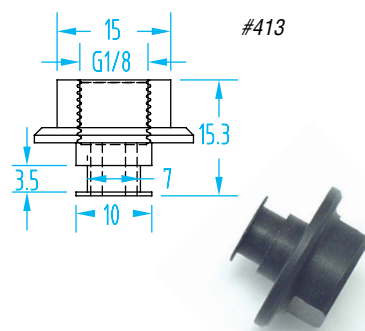
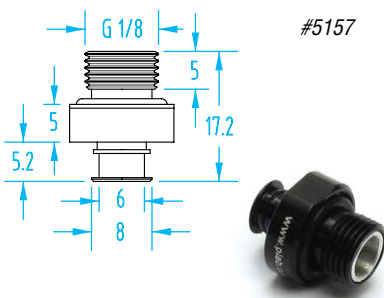

OEM, ShorTec & PIAB - Nipples

(Shown Actual Size)

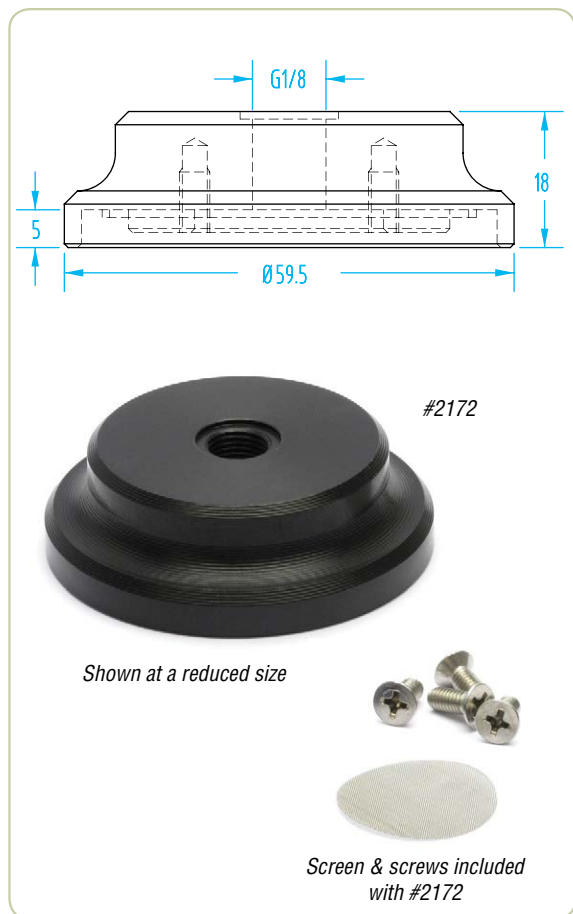
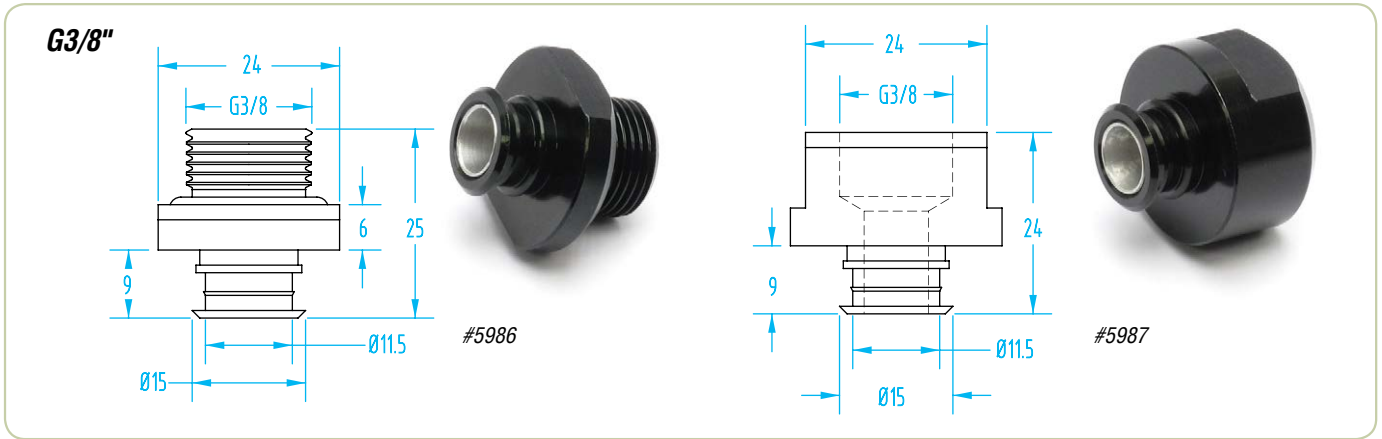
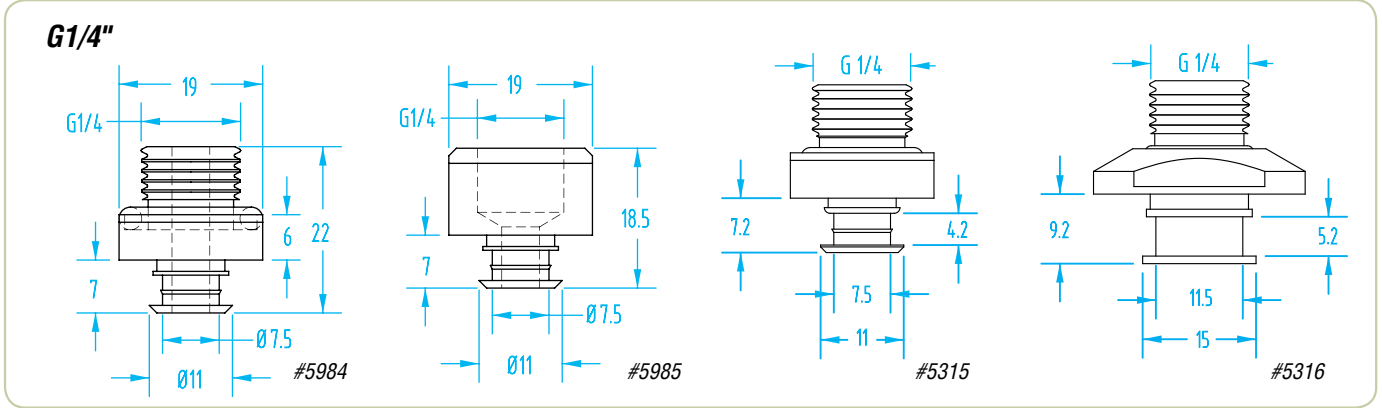

Nipples

Quick#	Part#	Nipple	Thread	Vacuum Cup Ø	Price
5464	GSF-MN15-M3	Male	M3	2-3mm	\$5.32
688	GSF-NF11-M5	Male	M5	5-7mm	\$2.20
411	GSF-NF1-M5	Male	M5	15mm	\$1.67
1438	GSV-01AB	Male	M5	4-8mm	\$1.76
1439	GSV-01AC	Male	M5	10-15mm	\$1.76
412	GSF-NF2-G8M5	Male/Female	G1/8" /M5	20-30mm	\$5.00
1440	GSV-02AF	Male/Female	G1/8" /M5	20-30mm	\$5.65
5982	F02-G8M	Male	G1/8"	20-30mm	\$2.88
5157	GSV-02AB	Male	G1/8"	20-30mm	\$5.97
5983	F02-G8F	Female	G1/8"	20-30mm	\$2.88
1441	GSV-04AG	Female	G1/8"	30-40mm	\$7.27
413	GSF-NF3-G8	Female	G1/8"	40mm	\$6.25
1442	GSV-05AG	Female	G1/8"	50mm	\$8.93
646	GSF-NF5-G8F	Female	G1/8"	50mm	\$5.50
2172	GSV-07UA	Female	G1/8"	75mm	\$26.45
5984	F03-G4M	Male	G1/4"	30-40mm	\$3.58
5985	F03-G4F	Female	G1/4"	30-40mm	\$3.58
5315	GSV-04AB	Male	G1/4"	35mm	\$8.43
5316	GSV-05AB	Male	G1/4"	50mm	\$10.41
5986	F04-G3M	Male	G3/8"	50mm	\$3.92
5987	F04-G3F	Female	G3/8"	50mm	\$3.92

Reference our Compatibility Chart on pages 240-241 to determine which nipple to use for OEM, ShorTec & PIAB Vacuum Cups!

OEM, ShorTec & PIAB - Nipples

Compatibility Chart

		Quick#	5464	688	1438	411	1439	412	1440	5157	5982	5983
		Brand	Piab	OEM	Piab	OEM	Piab	OEM	Piab	Piab	ShorTec	ShorTec
		Thread	M3-M	M5-M	M5-M	M5-M	M5-M	G1/8-M / M5-F	G1/8-M / M5-F	G1/8-M	G1/8-M	G1/8-F
2mm	Piab (flat-smooth)		✓									
3mm	Piab (flat-smooth)		✓									
4mm	Piab (flat-smooth)			✓	✓							
5mm	Piab (1.5 bellows)			✓	✓							
	OEM (flat-smooth)			✓	✓							
6mm	Piab (flat-smooth)			✓	✓							
7mm	OEM (flat-smooth)			✓	✓							
8mm	Piab (flat-smooth, 1.5 bellows)			✓	✓							
10mm	Piab (flat-smooth, 1.5 bellows, Duraflex)					✓	✓					
11mm	OEM (flat-smooth, 1.5 bellows)					✓	✓					
15mm	Piab (flat, 1.5 bellows, deep, Duraflex)					✓	✓					
	ShorTec (1.5 bellows)					✓	✓					
16mm	OEM (flat, 1.5 bellows)					✓	✓					
20mm	Piab (flat, 1.5 bellows, deep, Duraflex)							✓	✓	✓	✓	✓
	OEM (flat, 1.5 bellows)							✓	✓	✓	✓	✓
	ShorTec (1.5 bellows, 2.5 bellows)							✓	✓	✓	✓	✓
25mm	Piab (flat-ribbed, Duraflex)							✓	✓	✓	✓	✓
	OEM (flat-ribbed)							✓	✓	✓	✓	✓
	ShorTec (2.5 bellows with large lip)							✓	✓	✓	✓	✓
30mm	Piab (flat, 1.5 bellows, deep)							✓	✓	✓	✓	✓
	OEM (flat-smooth, flat-ribbed)							✓	✓	✓	✓	✓
30mm	ShorTec (1.5 bellows, 2.5 bellows)											
30mm*	Piab (1.5 bellows - 2nd generation)											
35mm	Piab (Duraflex)											
	ShorTec (2.5 bellows with large lip)										✓	✓
40mm	Piab (flat, 1.5 bellows)											
	OEM (flat, 1.5 bellows)											
	ShorTec (1.5 bellows, 2.5 bellows)											
45mm	ShorTec (2.5 bellows with large lip)											
50mm	Piab (flat, 1.5 bellows, deep)											
	OEM (flat, 1.5 bellows)											
	ShorTec (1.5 bellows, 2.5 bellows)											
52mm	Piab (Duraflex)											
55mm	ShorTec (2.5 bellows with large lip)											

* Piab 2nd generation cup takes a larger fitting

OEM, ShorTec & PIAB - Nipples

		Quick#	413	1441	5984	5985	5315	5316	646	1442	5986	5987
	Brand	OEM	Piab	ShorTec	ShorTec	PIAB	PIAB	OEM	Piab	ShorTec	ShorTec	
	Thread	G1/8-F	G1/8-F	G1/4-M	G1/4-F	G1/4-M	G1/4-M	G1/8-F	G1/8-F	G3/8-M	G3/8-F	
2mm	Piab (flat-smooth)											
3mm	Piab (flat-smooth)											
4mm	Piab (flat-smooth)											
5mm	Piab (1.5 bellows)											
	OEM (flat-smooth)											
6mm	Piab (flat-smooth)											
7mm	OEM (flat-smooth)											
8mm	Piab (flat-smooth, 1.5 bellows)											
10mm	Piab (flat-smooth, 1.5 bellows, Duraflex)											
11mm	OEM (flat-smooth, 1.5 bellows)											
15mm	Piab (flat, 1.5 bellows, deep, Duraflex)											
	ShorTec (1.5 bellows)											
16mm	OEM (flat, 1.5 bellows)											
20mm	Piab (flat, 1.5 bellows, deep, Duraflex)											
	OEM (flat, 1.5 bellows)											
	ShorTec (1.5 bellows, 2.5 bellows)											
25mm	Piab (flat-ribbed, Duraflex)											
	OEM (flat-ribbed)											
	ShorTec (2.5 bellows with large lip)											
30mm	Piab (flat, 1.5 bellows, deep)											
	OEM (flat-smooth, flat-ribbed)											
30mm	ShorTec (1.5 bellows, 2.5 bellows)			✓	✓							
30mm*	Piab (1.5 bellows - 2nd generation)	✓	✓	✓	✓							
35mm	Piab (Duraflex)		✓	✓	✓	✓						
	ShorTec (2.5 bellows with large lip)											
40mm	Piab (flat, 1.5 bellows)	✓	✓	✓	✓							
	OEM (flat, 1.5 bellows)	✓	✓	✓	✓							
	ShorTec (1.5 bellows, 2.5 bellows)	✓	✓	✓	✓							
45mm	ShorTec (2.5 bellows with large lip)			✓	✓							
50mm	Piab (flat, 1.5 bellows, deep)								✓	✓	✓	✓
	OEM (flat, 1.5 bellows)								✓	✓	✓	✓
	ShorTec (1.5 bellows, 2.5 bellows)								✓	✓	✓	✓
52mm	Piab (Duraflex)						✓	✓	✓	✓	✓	
55mm	ShorTec (2.5 bellows with large lip)									✓	✓	

* Piab 2nd generation cup takes a larger fitting

>S< Style - Flat

(Shown Actual Size)



>S< Style Vacuum Cup Properties

Material	Color	Max Temp.	Durometer
Silicone	Semi-translucent white	482°F	55°
Polyurethane	Blue	248°F	55°
Nitrile	Black	248°F	55°

Available with Foam Cup, see page 250.

See page 254 for nipple dimensions.

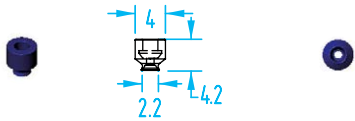

Cup Ø	Material	Quick#	Part#	(Reference)	Price
2mm	SIL	3187	VN1-2-S	PFG-2A-SI	\$3.18
	PU	3188	VN1-2-P	PFG-2A-U	\$8.10
	NIT	3186	VN1-2-N	PFG-2A-NBR	\$2.50
Nipple		3286	VSA10	M5 Male	\$2.80

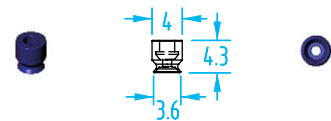

Cup Ø	Material	Quick#	Part#	(Reference)	Price
3.5mm	SIL	3190	VN1-3.5-S	PFG-3.5A-SI	\$3.18
	PU	3191	VN1-3.5-P	PFG-3.5A-U	\$8.10
	NIT	3189	VN1-3.5-N	PFG-3.5A-NBR	\$2.58
Nipple		3286	VSA10	M5 Male	\$2.80

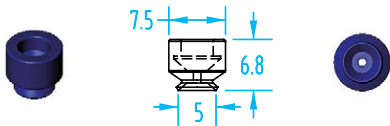

Cup Ø	Material	Quick#	Part#	(Reference)	Price
5mm	SIL	3193	VN1-5-S	PFG-5A-SI	\$2.72
	PU	3194	VN1-5-P	PFG-5A-U	\$4.00
	NIT	3192	VN1-5-N	PFG-5A-NBR	\$2.16
Nipple		3289	VSA30	M5 Male	\$2.80
		5178	VSA30F	M5 Female	\$2.80

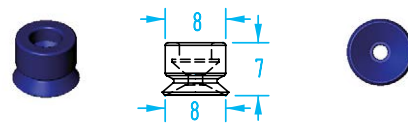

Cup Ø	Material	Quick#	Part#	(Reference)	Price
8mm	SIL	3196	VN1-8-S	PFG-8A-SI	\$2.72
	PU	3197	VN1-8-P	PFG-8A-U	\$4.00
	NIT	3195	VN1-8-N	PFG-8A-NBR	\$2.33
Nipple		3289	VSA30	M5 Male	\$2.80
		5178	VSA30F	M5 Female	\$2.80

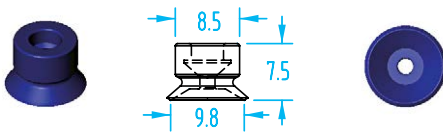

Cup Ø	Material	Quick#	Part#	(Reference)	Price
10mm	SIL	3200	VN1-10-S	PFG-10A-SI	\$2.84
	PU	3201	VN1-10-P	PFG-10A-U	\$4.38
	NIT	3199	VN1-10-N	PFG-10A-NBR	\$2.58
Nipple		3289	VSA30	M5 Male	\$2.80
		5178	VSA30F	M5 Female	\$2.80

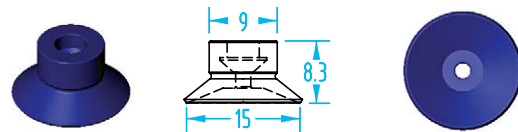

Cup Ø	Material	Quick#	Part#	(Reference)	Price
15mm	SIL	3204	VN1-15-S	PFG-15A-SI	\$4.95
	PU	3205	VN1-15-P	PFG-015A-U	\$4.38
	NIT	3203	VN1-15-N	PFG-15A-NBR	\$2.28
Nipple		3289	VSA30	M5 Male	\$2.80
		5178	VSA30F	M5 Female	\$2.80

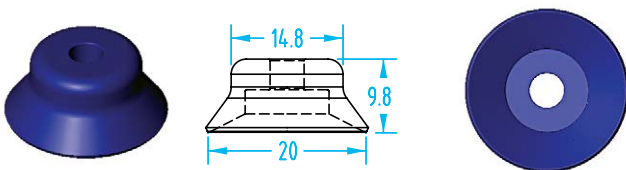

Cup Ø	Material	Quick#	Part#	(Reference)	Price
20mm	SIL	3207	VN1-20-S	PFG-20-SI	\$2.50
	PU	3208	VN1-20-P	PFG-20-U	\$4.16
	NIT	3206	VN1-20-N	PFG-20A-NBR	\$2.88
Nipple		3291	VSA50	G1/8" Male	\$3.17
		5179	VSA50F	G1/8" Female	\$5.10

>S< Style - Flat

(Shown Actual Size)

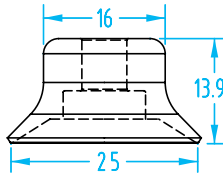

Cup Ø	Material	Quick#	Part#	(Reference)	Price
25mm	SIL	3211	VN1-25-S	PFG-25-SI	\$2.50
	PU	3212	VN1-25-P	PFG-25-U	\$4.20
	NIT	3210	VN1-25-N	PFG-25A-NBR	\$2.31
Nipple		3292	VSA60	G1/8" Male	\$3.17
		5180	VSA60F	G1/8" Female	\$3.33

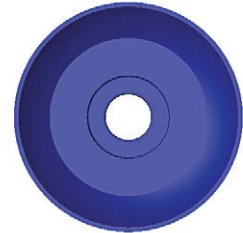
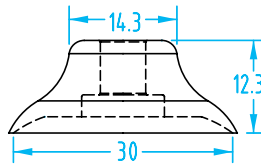

Cup Ø	Material	Quick#	Part#	(Reference)	Price
30mm	SIL	3215	VN1-30-S	PFG-30-SI	\$2.62
	NIT	3214	VN1-30-N	PFG-30A-NBR	\$2.49
Nipple		3292	VSA60	G1/8" Male	\$3.17
		5180	VSA60F	G1/8" Female	\$3.33

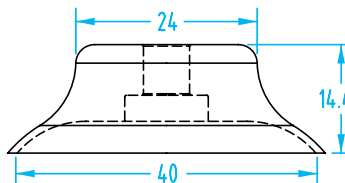

Cup Ø	Material	Quick#	Part#	(Reference)	Price
40mm	SIL	3219	VN1-40-S	PFG-40-SI	\$2.82
	PU	3220	VN1-40-P	PFG-40-U	\$4.84
	NIT	3218	VN1-40-N	PFG-40A-NBR	\$2.69
Nipple		3292	VSA60	G1/8" Male	\$3.17
		5180	VSA60F	G1/8" Female	\$3.33

Fittings Available on page 935



>S< Style - Flat

(Shown Actual Size)



>S< Style Vacuum Cup Properties

Material	Color	Max Temp.	Durometer
Silicone	Semi-translucent white	482°F	55°
Polyurethane	Blue	248°F	55°
Nitrile	Black	248°F	55°

Available with Foam Cup, see page 250.

See page 254 for nipple dimensions.

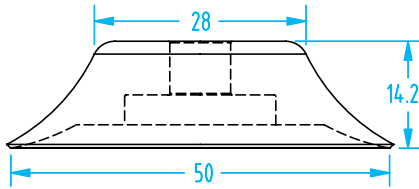
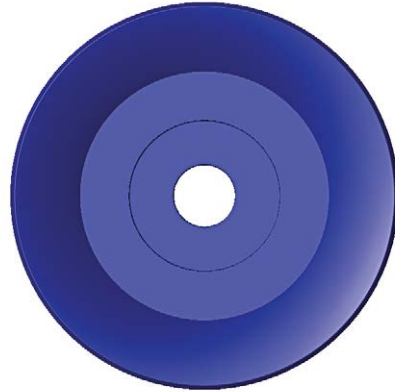

Cup Ø	Material	Quick#	Part#	(Reference)	Price
50mm	SIL	3223	VN1-50-S	PFG-50-SI	\$2.80
	PU	3224	VN1-50-P	PFG-50-U	\$5.32
	NIT	3222	VN1-50-N	PFG-50A-NBR	\$3.08
Nipple		3294	VSA80	G1/8" Male	\$3.50
		5182	VSA80F	G1/8" Female	\$3.50

Vacuum Cups

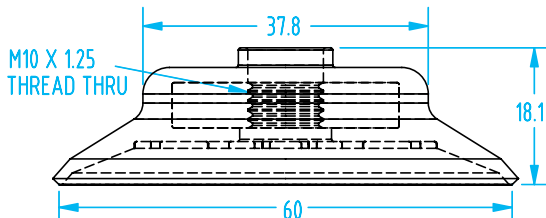

Cup Ø	Material	Quick#	Part#	(Reference)	Price
60mm	SIL	3227	VN1-60-S	PFG-60-SI	\$7.04
	NIT	3226	VN1-60-N	PFG-60A-NBR	\$8.31
Nipple		3297	VSA110	G1/4" Male	\$5.32
		5183	VSA110F	G1/4" Female	\$5.32

>S< Style - Flat

(Shown Actual Size)

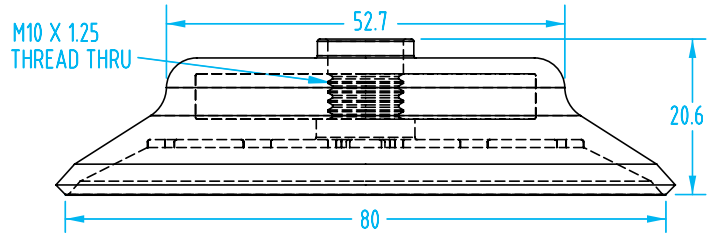
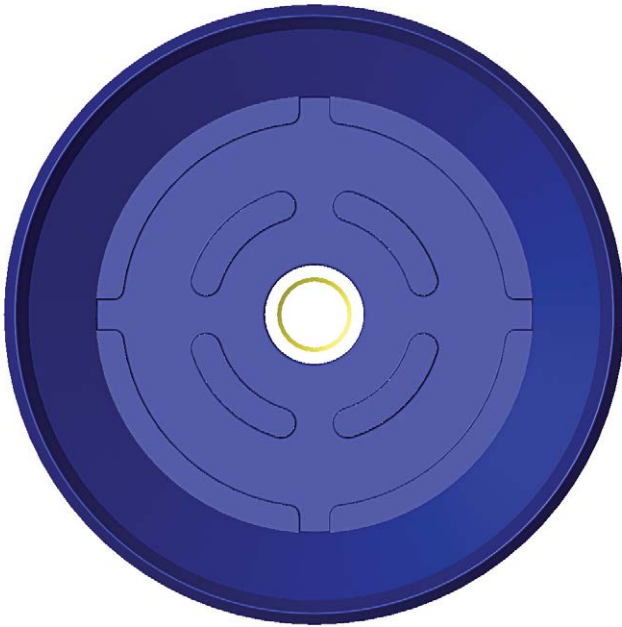

Cup Ø	Material	Quick#	Part#	(Reference)	Price
80mm	SIL	3230	VN1-80-S	PFG-80-SI	\$13.05
	PU	3231	VN1-80-P	PFG-80-U	\$13.70
	NIT	3229	VN1-80-N	PFG-80A-NBR	\$9.69
Nipple		3297	VSA110	G1/4" Male	\$5.32
		5183	VSA110F	G1/4" Female	\$5.32

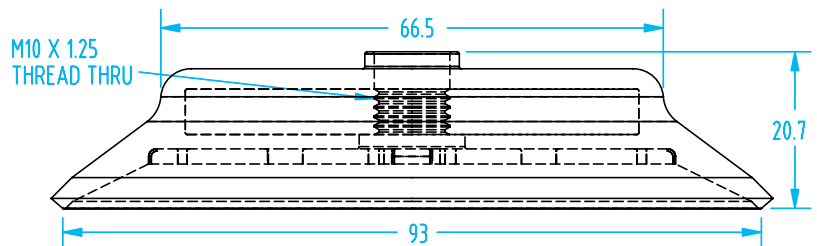
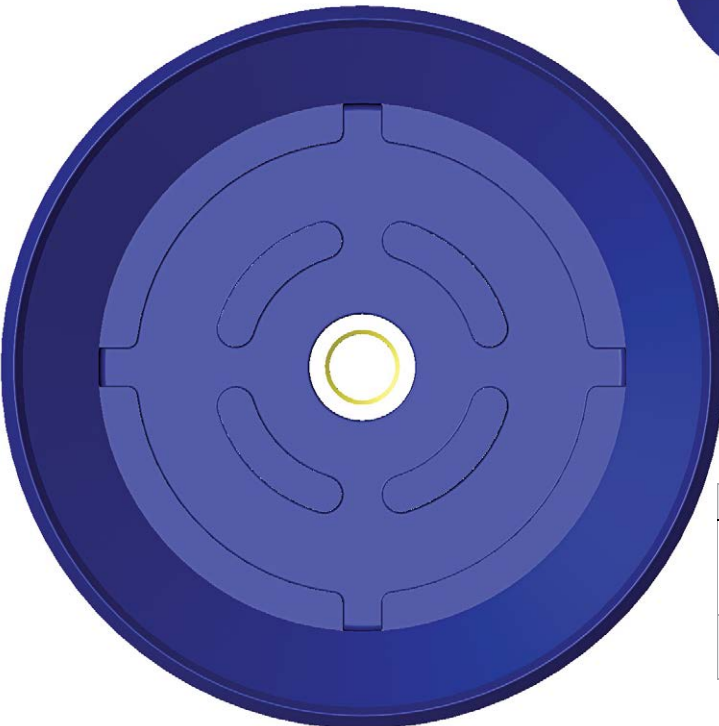

Cup Ø	Material	Quick#	Part#	(Reference)	Price
95mm	SIL	3233	VN1-95-S	PFG-95-SI	\$16.99
	PU	3234	VN1-95-P	PFG-95-U	\$21.11
	NIT	3232	VN1-95-N	PFG-95A-NBR	\$16.26
Nipple		3297	VSA110	G1/4" Male	\$5.32
		5183	VSA110F	G1/4" Female	\$5.32

>S< Style - 1.5 Bellows

(Shown Actual Size)



>S< Style Vacuum Cup Properties

Material	Color	Max Temp.	Durometer
Silicone	Semi-translucent white	482°F	55°
Polyurethane	Blue	248°F	55°
Nitrile	Black	248°F	55°

Available with Foam Cup, see page 250.

See page 254 for nipple dimensions.

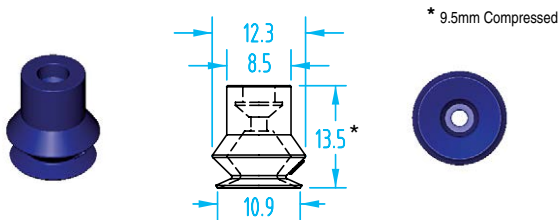

Cup Ø	Material	Quick#	Part#	(Reference)	Price
10mm	NIT	3235	VN2-10-N	PBG-10A-NBR	\$3.34
	SIL	3236	VN2-10-S	PBG-10A-SI	\$5.20
	PU	3237	VN2-10-P	PBG-10A-U	\$7.20
Nipple		3289	VSA30	M5 Male	\$2.80
		5178	VSA30F	M5 Female	\$2.80

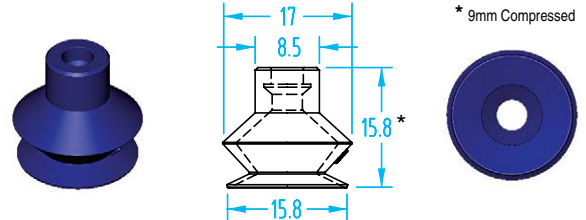

Cup Ø	Material	Quick#	Part#	(Reference)	Price
15mm	NIT	3238	VN2-15-N	PBG-15A-NBR	\$4.00
	SIL	3239	VN2-15-S	PBG-15A-SI	\$7.00
	PU	3240	VN2-15-P	PBG-15A-U	\$8.68
Nipple		3289	VSA30	M5 Male	\$2.80
		5178	VSA30F	M5 Female	\$2.80

* 16mm Compressed

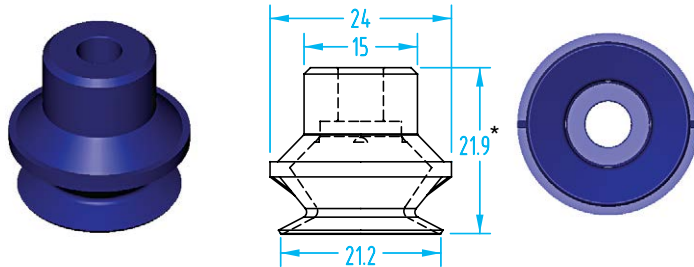

Cup Ø	Material	Quick#	Part#	(Reference)	Price
20mm	NIT	3241	VN2-20-N	PBG-20-NBR	\$3.66
	SIL	3242	VN2-20-S	PBG-20-SI	\$6.92
	PU	3243	VN2-20-P	PBG-20-U	\$8.58
Nipple		3292	VSA60	G1/8" Male	\$3.17
		5180	VSA60F	G1/8" Female	\$3.33

* 20mm Compressed

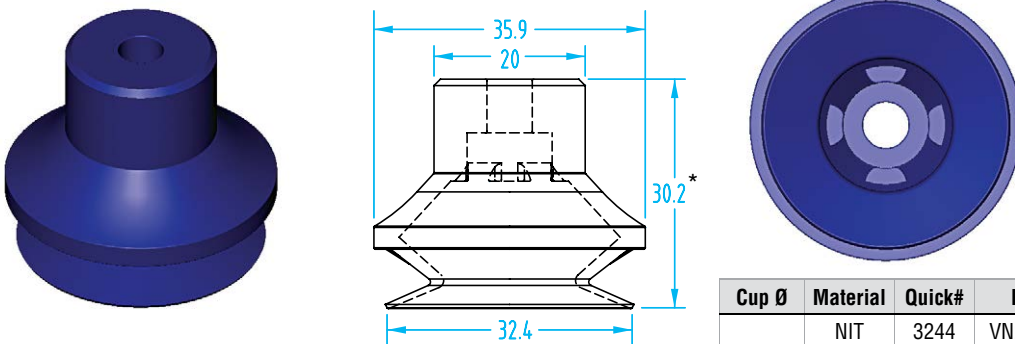

Cup Ø	Material	Quick#	Part#	(Reference)	Price
30mm	NIT	3244	VN2-30-N	PBG-30-NBR	\$4.70
	SIL	3245	VN2-30-S	PBG-30-SI	\$7.72
	PU	3246	VN2-30-P	PBG-30-U	\$10.86
Nipple		3292	VSA60	G1/8" Male	\$3.17
		5180	VSA60F	G1/8" Female	\$3.33

>S< Style - 1.5 Bellows

(Shown Actual Size)

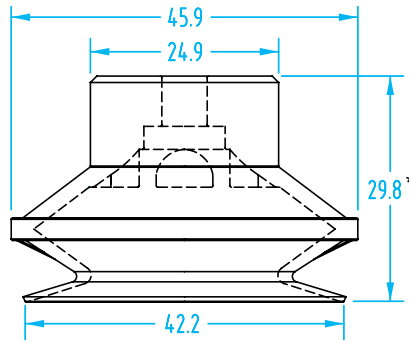
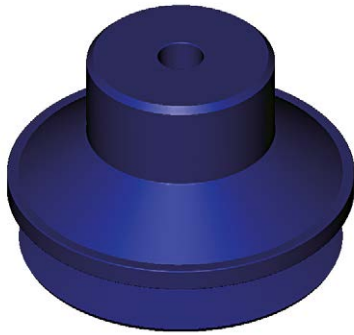

* 20mm Compressed

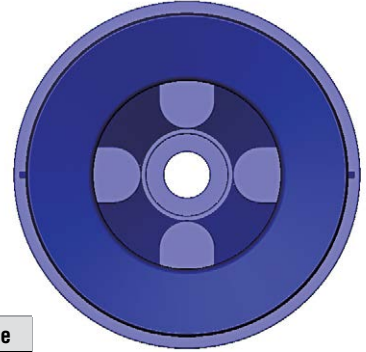

Cup Ø	Material	Quick#	Part#	(Reference)	Price
40mm	NIT	3247	VN2-40-N	PBG-40-NBR	\$6.24
	SIL	3248	VN2-40-S	PBG-40-SI	\$12.30
	PU	3249	VN2-40-P	PBG-40-U	\$14.28
Nipple		3292	VSA60	G1/8" Male	\$3.17
		5180	VSA60F	G1/8" Female	\$3.33

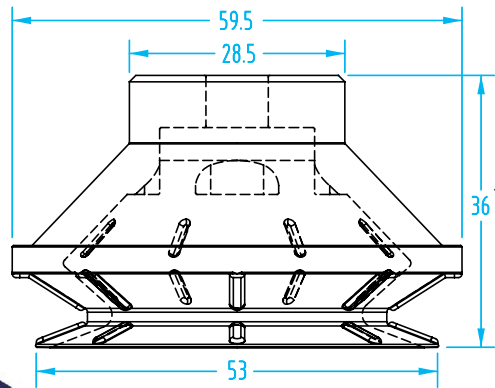
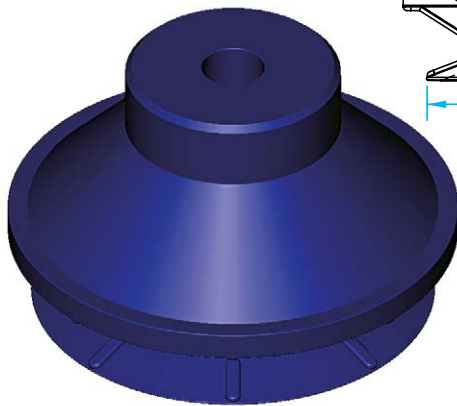

* 24mm Compressed

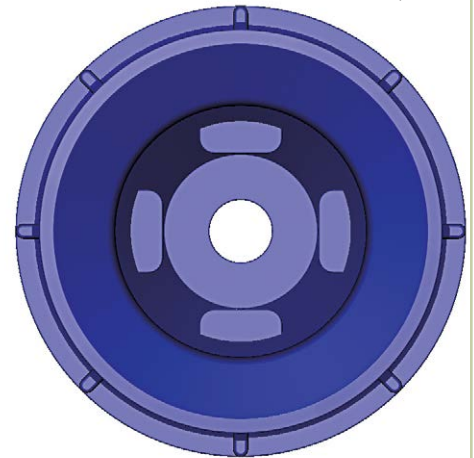

Cup Ø	Material	Quick#	Part#	(Reference)	Price
50mm	NIT	3250	VN2-50-N	PBG-50-NBR	\$6.92
	SIL	3251	VN2-50-S	PBG-50-SI	\$12.62
	PU	3252	VN2-50-P	PBG-50-U	\$22.70
Nipple		3294	VSA80	G1/8" Male	\$3.50
		5182	VSA80F	G1/8" Female	\$3.50

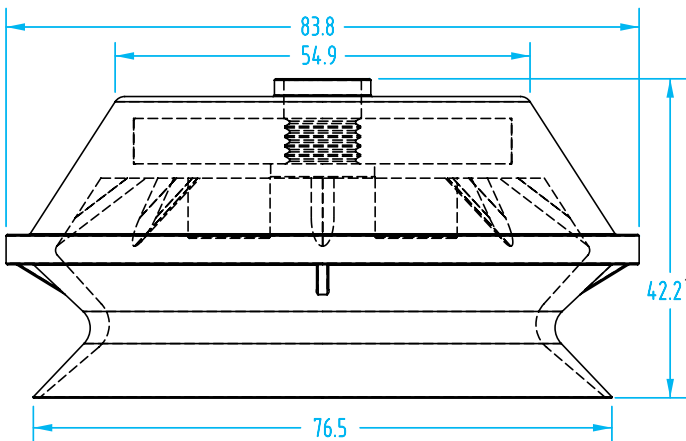

* 20mm Compressed

Cup Ø	Material	Quick#	Part#	(Reference)	Price
75mm	NIT	3253	VN2-75-N	PBG-75-NBR	\$18.04
	SIL	3254	VN2-75-S	PBG-75-SI	\$26.56
	PU	3255	VN2-75-P	PBG-75-U	\$52.08
Nipple		3297	VSA110	G1/4" Male	\$5.32
		5183	VSA110F	G1/4" Female	\$5.32

>S< Style - 2.5 Bellows

(Shown Actual Size)



>S< Style Vacuum Cup Properties

Material	Color	Max Temp.	Durometer
Silicone	Semi-translucent white	482°F	55°
Polyurethane	Blue	248°F	55°
Nitrile	Black	248°F	55°

See page 254 for nipple dimensions.

* 8mm Compressed

Cup Ø	Material	Quick#	Part#	(Reference)	Price
5mm	NIT	3256	VN3-5-N	PCG-5-NBR	\$4.18
	SIL	3257	VN3-5-S	PCG-5-SI	\$4.98
	PU	3258	VN3-5-P	PCG-5-U	\$8.04
Nipple		3289	VSA30	M5 Male	\$2.80
		5178	VSA30F	M5 Female	\$2.80

* 8mm Compressed

Cup Ø	Material	Quick#	Part#	(Reference)	Price
7mm	NIT	3259	VN3-8-N	PCG-7-NBR	\$4.18
	SIL	3260	VN3-8-S	PCG-7-SI	\$4.98
	PU	3261	VN3-8-P	PCG-7-U	\$8.04
Nipple		3289	VSA30	M5 Male	\$2.80
		5178	VSA30F	M5 Female	\$2.80

* 12.5mm Compressed

Cup Ø	Material	Quick#	Part#	(Reference)	Price
10mm	NIT	3262	VN3-10-N	PCG-10-NBR	\$3.02
	SIL	3263	VN3-10-S	PCG-10-SI	\$3.76
	PU	3264	VN3-10-P	PCG-10-U	\$6.58
Nipple		3290	VSA40	M5 Male	\$1.77
		1603	GSF-PFN-G8F	G1/8" Female	\$3.80

* 15mm Compressed

Cup Ø	Material	Quick#	Part#	(Reference)	Price
15mm	NIT	3265	VN3-15-N	PCG-15-NBR	\$3.02
	SIL	3266	VN3-15-S	PCG-15-SI	\$3.67
	PU	3267	VN3-15-P	PCG-15-U	\$6.88
Nipple		3290	VSA40	M5 Male	\$1.77
		1603	GSF-PFN-G8F	G1/8" Female	\$3.80

* 15mm Compressed

Cup Ø	Material	Quick#	Part#	(Reference)	Price
18mm	NIT	3268	VN3-18-N	PCG-18-NBR	\$6.08
	SIL	3269	VN3-18-S	PCG-18-SI	\$4.24
	PU	3270	VN3-18-P	PCG-18-U	\$7.88
Nipple		1604	GSF-PFN-G8M	G1/8" Male	\$3.80
		1603	GSF-PFN-G8F	G1/8" Female	\$3.80

* 14mm Compressed

Cup Ø	Material	Quick#	Part#	(Reference)	Price
20mm	NIT	3271	VN3-20-N	PCG-20-NBR	\$3.64
	SIL	3272	VN3-20-S	PCG-20-SI	\$4.36
	PU	3273	VN3-20-P	PCG-20-U	\$8.54
Nipple		1604	GSF-PFN-G8M	G1/8" Male	\$3.80
		1603	GSF-PFN-G8F	G1/8" Female	\$3.80

>S< Style - 2.5 Bellows

(Shown Actual Size)

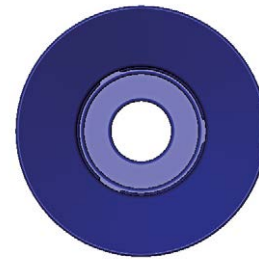
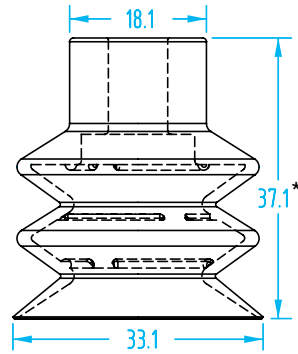

* 24mm Compressed

Cup Ø	Material	Quick#	Part#	(Reference)	Price
30mm	NIT	3274	VN3-30-N	PCG-30-NBR	\$4.88
	SIL	3275	VN3-30-S	PCG-30-SI	\$6.78
	PU	3276	VN3-30-P	PCG-30-U	\$12.66
Nipple		5433	GSF-HTN1-G8M	G1/8" Male	\$3.67
		5432	GSF-HTN1-G8F	G1/8" Female	\$4.00

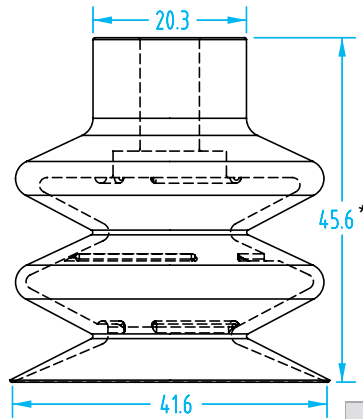
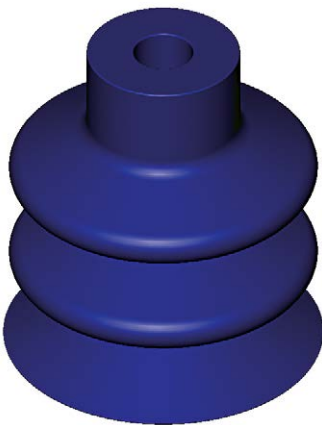

* 28mm Compressed

Cup Ø	Material	Quick#	Part#	(Reference)	Price
40mm	NIT	3277	VN3-40-N	PCG-40-NBR	\$6.90
	SIL	3278	VN3-40-S	PCG-40-SI	\$8.62
Nipple		5433	GSF-HTN1-G8M	G1/8" Male	\$3.67
		5432	GSF-HTN1-G8F	G1/8" Female	\$4.00

Cup Ø	Material	Quick#	Part#	(Reference)	Price
60mm	NIT	3280	VN3-60-N	PCG-60-NBR	\$11.14
	SIL	3281	VN3-60-S	PCG-60-SI	\$14.08
	PU	3282	VN3-60-P	PCG-60-U	\$29.66
Nipple		5433	GSF-HTN1-G8M	G1/8" Male	\$3.67
		5432	GSF-HTN1-G8F	G1/8" Female	\$4.00

Cup Ø	Material	Quick#	Part#	(Reference)	Price
90mm	NIT	3283	VN3-90-N	PCG-90-NBR	\$22.18
	SIL	3284	VN3-90-S	PCG-90-SI	\$30.72
Nipple		3296	VSA100	G1/4" Male	\$5.06
		1607	GSF-PFN4-G4F	G1/4" Female	\$6.42

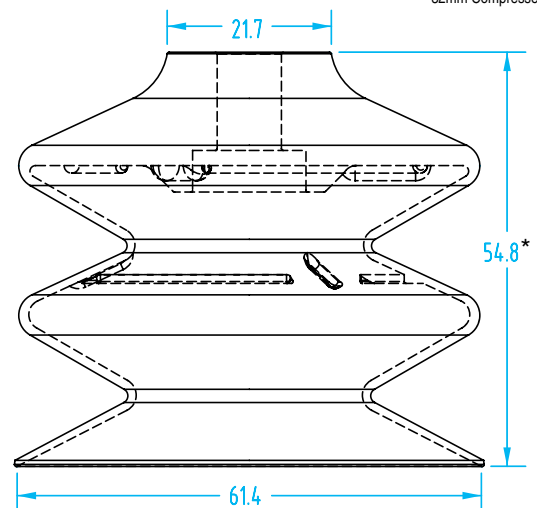

* 32mm Compressed

>S< Style - Foam Surface - Flat

(Shown Actual Size)



Foam cups are designed for gripping products with an uneven or ridged surface such as metal sheets or flat surfaces with bumps or hollows. Heat-resistant silicone cups have a temperature range up to 428°F, and don't leave marks on products handled. Silicone foam cups are not recommended for gripping products before painting or lacquering.

Foam Vacuum Cup Properties

Material	Color	Max Temp.	Cup Durometer
Nitrile	Black	176°	60°
Silicone	Clear	428°	50°

Vacuum Cups

See page 254 for nipple dimensions.

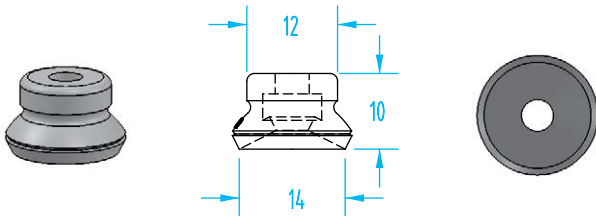

Cup Ø	Material	Quick#	Part#	Price
15mm	Nitrile	1049	VPG-15-NBR-BM	\$11.58
	Silicone	1050	VPG-15-SI-BM	\$11.92
Nipple	M5 Male	3290	VSA40	\$1.77
	G1/8" Female	1603	GSF-PFN-G8F	\$3.80

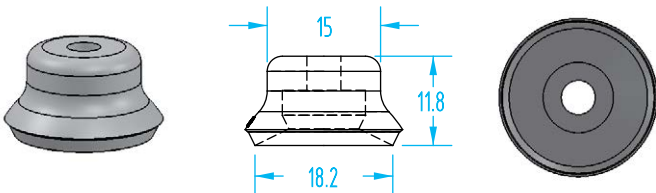

Cup Ø	Material	Quick#	Part#	Price
20mm	Nitrile	1051	VPG-20-NBR-BM	\$12.08
	Silicone	1052	VPG-20-SI-BM	\$12.50
Nipple	G1/8" Male	1604	GSF-PFN-G8M	\$3.80
	G1/8" Female	1603	GSF-PFN-G8F	\$3.80

>S< Style - Foam Surface - Flat

(Shown Actual Size)

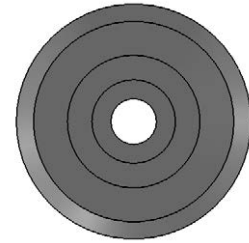
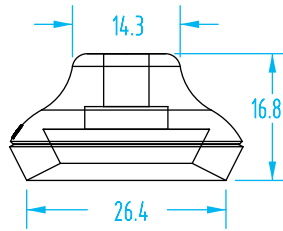

Cup Ø	Material	Quick#	Part#	Price
30mm	Nitrile	1053	VPG-30-NBR-BM	\$13.08
	Silicone	1054	VPG-30-SI-BM	\$14.92
Nipple	G1/8" Male	3292	VSA60	\$3.17
	G1/8" Female	5180	VSA60F	\$3.33

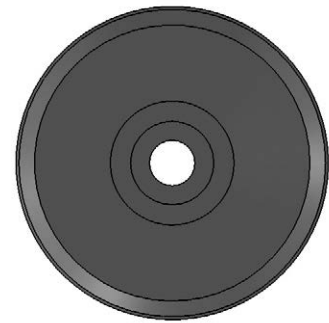
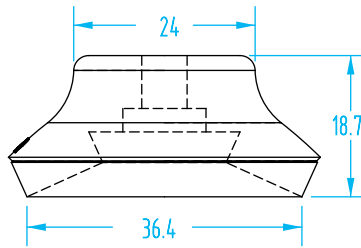
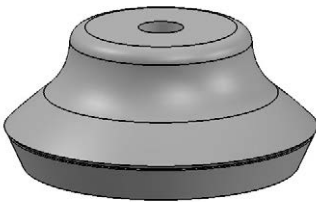

Cup Ø	Material	Quick#	Part#	Price
40mm	Nitrile	1055	VPG-40-NBR-BM	\$13.25
	Silicone	1056	VPG-40-SI-BM	\$15.92
Nipple	G1/8" Male	3292	VSA60	\$3.17
	G1/8" Female	5180	VSA60F	\$3.33

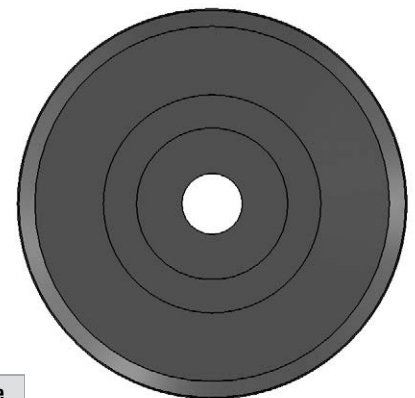
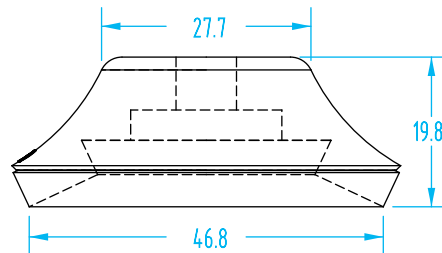
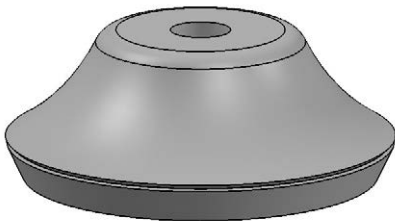

Cup Ø	Material	Quick#	Part#	Price
50mm	Nitrile	1057	VPG-50-NBR-BM	\$14.92
	Silicone	1058	VPG-50-SI-BM	\$17.42
Nipple	G1/8" Male	3294	VSA80	\$3.50
	G1/8" Female	5182	VSA80F	\$3.50

>S< Style - Foam Surface - 1.5 Bellow

(Shown Actual Size)



Foam cups are designed for gripping products with an uneven or ridged surface such as metal sheets or flat surfaces with bumps or hollows. Heat-resistant silicone cups have a temperature range up to 428°F, and don't leave marks on products handled. Silicone foam cups are not recommended for gripping products before painting or lacquering.

Foam Vacuum Cup Properties

Material	Color	Max Temp.	Cup Durometer
Nitrile	Black	176°	60°
Silicone	Clear	428°	50°

See page 254 for nipple dimensions.

Vacuum Cups

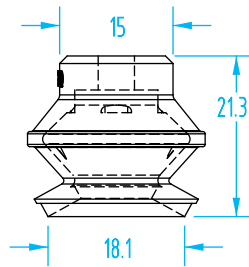
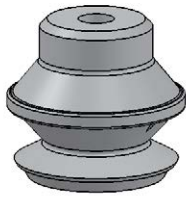

Cup Ø	Material	Quick#	Part#	Price
20mm	Nitrile	1059	VSAG-20-BNBR-BM	\$15.50
	Silicone	1060	VSAG-20-BSI-BM	\$18.10
Nipple	G1/8" Male	1604	GSF-PFN-G8M	\$3.80
	G1/8" Female	1603	GSF-PFN-G8F	\$3.80

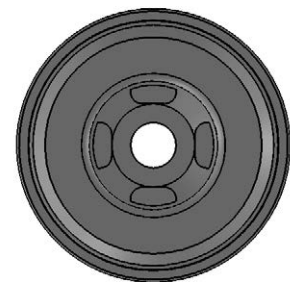
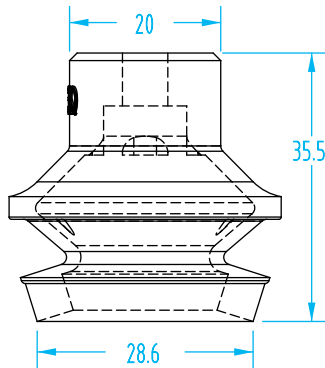
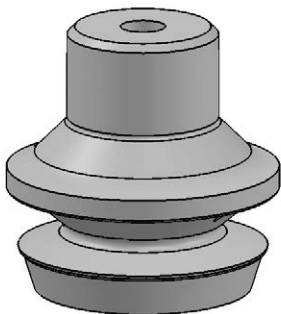

Cup Ø	Material	Quick#	Part#	Price
30mm	Nitrile	1061	VSAG-30-NBR-BM	\$16.00
	Silicone	1062	VSAG-30-SI-BM	\$19.00
Nipple	G1/8" Male	3292	VSA60	\$3.17
	G1/8" Female	5180	VSA60F	\$3.33

>S< Style - Foam Surface - 1.5 Bellow

(Shown Actual Size)

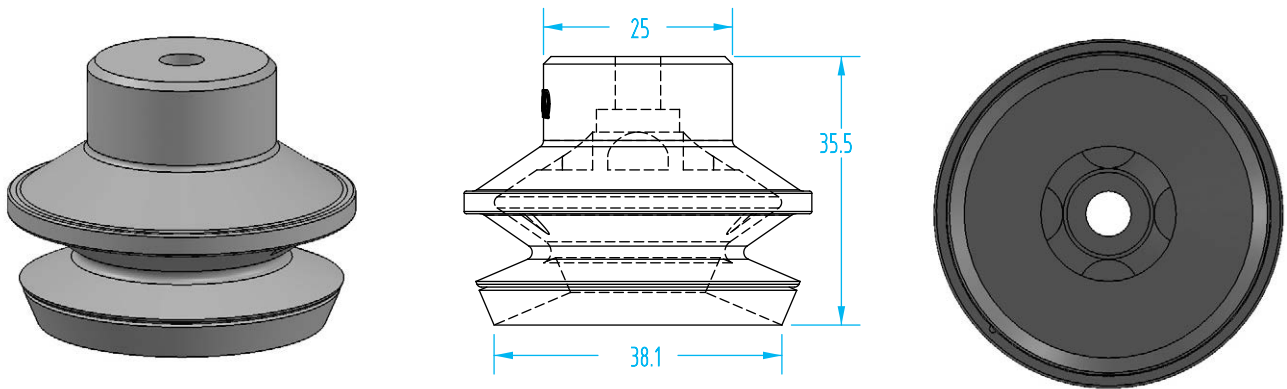

Cup Ø	Material	Quick#	Part#	Price
40mm	Nitrile	1063	VSAG-40-NBR-BM	\$19.20
	Silicone	1064	VSAG-40-SI-BM	\$22.00
Nipple	G1/8" Male	3292	VSA60	\$3.17
	G1/8" Female	5180	VSA60F	\$3.33

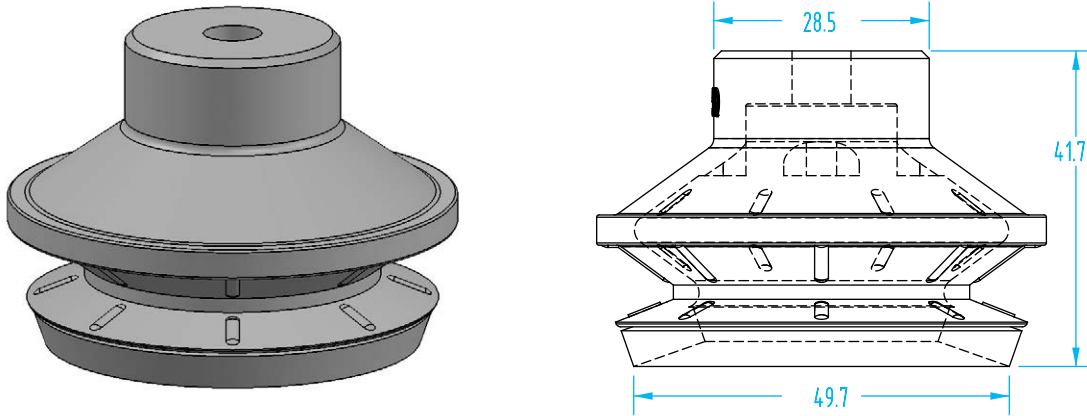

Cup Ø	Material	Quick#	Part#	Price
50mm	Nitrile	1065	VSAG-50-NBR-BM	\$20.40
	Silicone	1066	VSAG-50-SI-BM	\$26.10
Nipple	G1/8" Male	3294	VSA80	\$3.50
	G1/8" Female	5182	VSA80F	\$3.50

>S< Style - Nipples

(Shown Actual Size)

M5

#3286

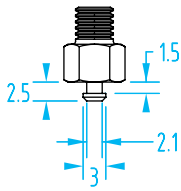

#3289

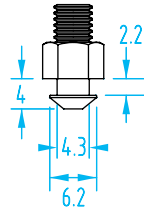

#5178

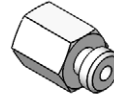
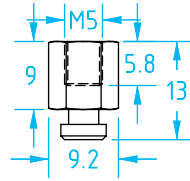

#3290

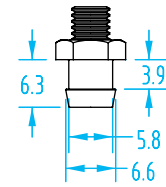

G1/8"

#3291

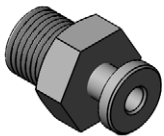
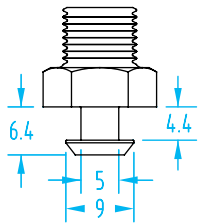

#5179

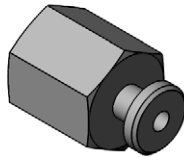
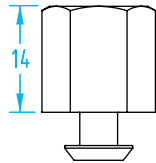

#3292

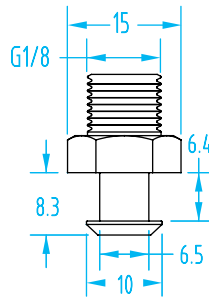

#5180

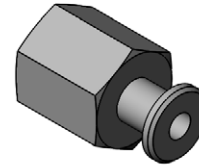
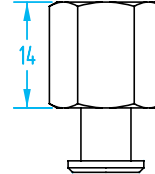

#1604

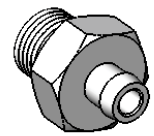
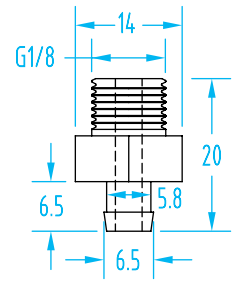

#1603

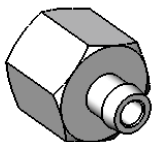
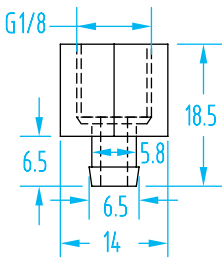

#3294

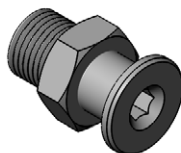
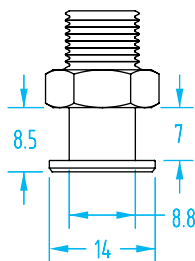

#5182

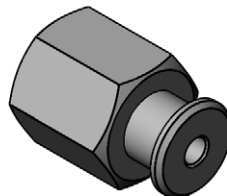
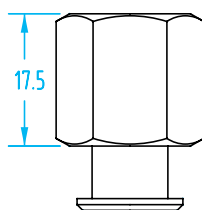

#5433

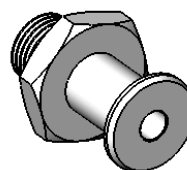
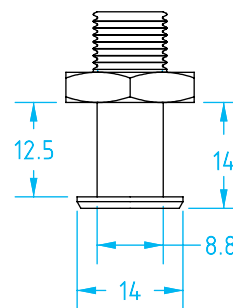

#5432

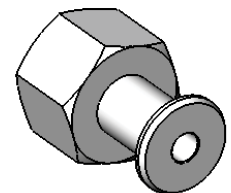
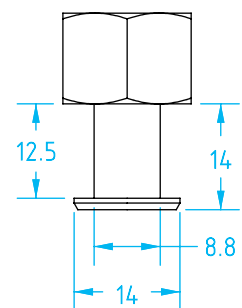

>S< Style - Nipples

(Shown Actual Size)

G1/4"

#3296

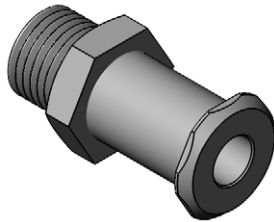
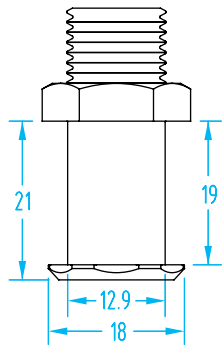

#1607

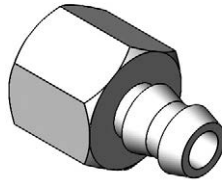
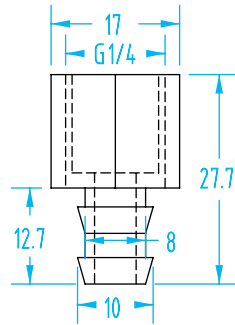

#3297

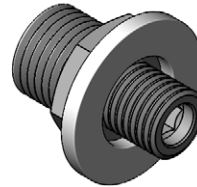
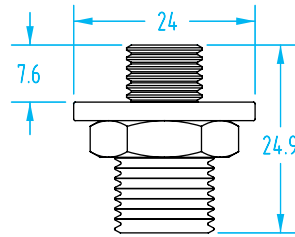

#5183

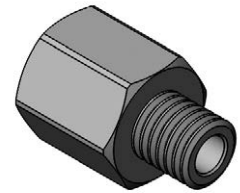
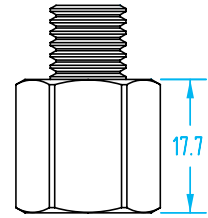

Quick#	Part#	Thread	Price
3286	VSA10	M5 Male	\$2.80
3289	VSA30	M5 Male	\$2.80
5178	VSA30F	M5 Female	\$2.80
3290	VSA40	M5 Male	\$1.77
3291	VSA50	G1/8" Male	\$3.17
5179	VSA50F	G1/8" Female	\$5.10
3292	VSA60	G1/8" Male	\$3.17
5180	VSA60F	G1/8" Female	\$3.33
1604	GSF-PFN-G8M	G1/8" Male	\$3.80
1603	GSF-PFN-G8F	G1/8" Female	\$3.80
3294	VSA80	G1/8" Male	\$3.50
5182	VSA80F	G1/8" Female	\$3.50
5433	GSF-HTN1-G8M	G1/8" Male	\$3.67
5432	GSF-HTN1-G8F	G1/8" Female	\$4.00
3296	VSA100	G1/4" Male	\$5.06
1607	GSF-PFN4-G4F	G1/4" Female	\$6.42
3297	VSA110	G1/4" Male	\$5.32
5183	VSA110F	G1/4" Female	\$5.32

Fittings Available
on page 935



SMC® Vacuum Cups - Introduction



SMC Vacuum Cup Properties

Material	Color	Max Temp.	Durometer
Silicone	Semi-translucent white	392°F	40°
Polyurethane	Semi-translucent gold	140°F	60°
Nitrile	Black	180°F	50°
Anti-static	Black	356°F	50°



Anti-static vacuum cups available.

SMC Vacuum Cups

SMC makes very nice quality and good performing vacuum cups. They are very well suited for most robotic EOAT applications. The silicone cups are more flexible because they have a softer durometer (40°) than most silicone cups (50°–55°). Therefore, they often provide a better seal on contoured parts or slightly textured parts.

And we make ordering them easy. Our simple step-by-step ordering guide makes it easy for you to build the vacuum cup and mounting assembly that is suited to your application. Full-size drawings assist you in getting the right size. And of course, our EOAT engineers are always available to provide engineering assistance.

How to Order SMC® Vacuum Cups

STEP 1 SELECT VACUUM CUP TYPE AND SIZE

Silicone, Polyurethane, Nitrile or Anti-static?
 Deep Cups on page 264.
 Bellows Cups on page 262.
 Flat Cups on page 258
 Flat Cups with Ridges on page 260.
 Nitrile Material available for all Cups
 Anti-Static Cups on page 258 & 262.

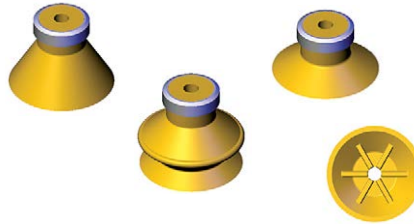

Vacuum cups 10mm and larger include clamp ring as standard.

STEP 2 DETERMINE REQUIRED NIPPLE

Vacuum cup nipples are ordered separately. See corresponding sizing chart on Page 265.

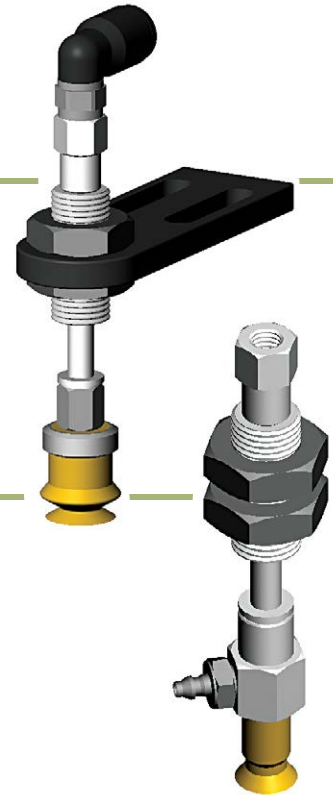

STEP 3 (OPTIONAL) ALTERNATE VACUUM ENTRY

Alternate vacuum entry adaptors are available with push-in tubing connectors. Page 265.



Vacuum Cups

STEP 4 (OPTIONAL) MOUNTING SUSPENSIONS

Also known as “buffers” and “level compensators”, these devices have internal springs. Page 266.



STEP 5 (OPTIONAL) MOUNTING BRACKETS

Custom aluminum brackets are available that allow for easy mounting and adjustment to popular types of aluminum framing profiles. Page 267.

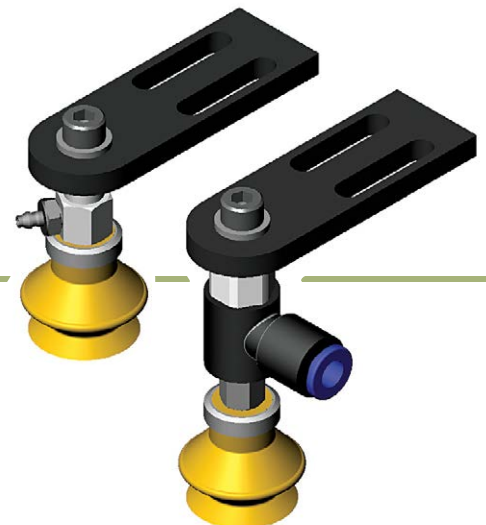

SMC® - Flat Smooth

(Shown Actual Size)



SMC Vacuum Cup Properties

Material	Color	Max Temp.	Durometer
Silicone	Semi-translucent white	392°F	40°
Polyurethane	Semi-translucent gold	140°F	60°
Nitrile	Black	180°F	50°
Anti-static	Black	356°F	50°

Order nipples separately, see page 265.

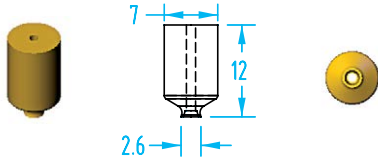

Cup Ø	Material	Quick#	Part#	Price
2mm	Silicone	2501	ZP02US	\$2.45
	Polyurethane	2535	ZP02UU	\$2.95
	Nitrile	2604	ZP02UN	\$2.25
	Anti-static	2683	ZP02UGS	\$2.40

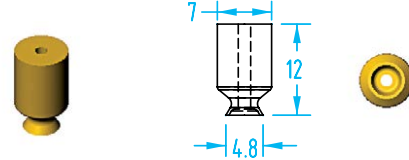

Cup Ø	Material	Quick#	Part#	Price
4mm	Silicone	2502	ZP04US	\$2.45
	Polyurethane	2536	ZP04UU	\$2.95
	Nitrile	2605	ZP04UN	\$2.25
	Anti-static	2684	ZP04UGS	\$2.40

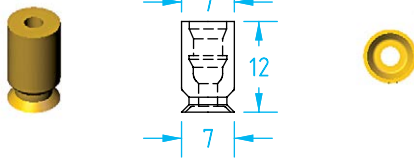

Cup Ø	Material	Quick#	Part#	Price
6mm	Silicone	2503	ZP06US	\$2.45
	Polyurethane	2537	ZP06UU	\$2.95
	Nitrile	2606	ZP06UN	\$2.25

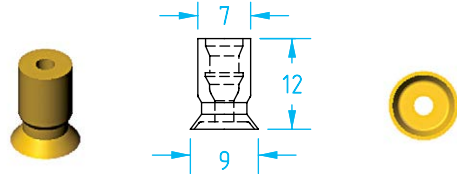

Cup Ø	Material	Quick#	Part#	Price
8mm	Silicone	2504	ZP08US	\$2.45
	Polyurethane	2538	ZP08UU	\$2.95
	Nitrile	2607	ZP08UN	\$2.25
	Anti-static	2685	ZP08UGS	\$2.40

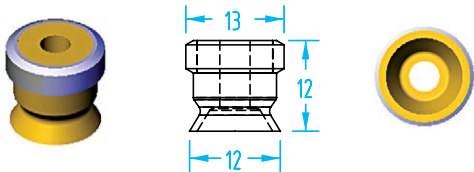

Cup Ø	Material	Quick#	Part#	Price
10mm	Silicone	2505	ZP10US	\$2.95
	Polyurethane	2539	ZP10UU	\$3.65
	Nitrile	2608	ZP10UN	\$2.70
	Anti-static	2686	ZP10UGS	\$4.23

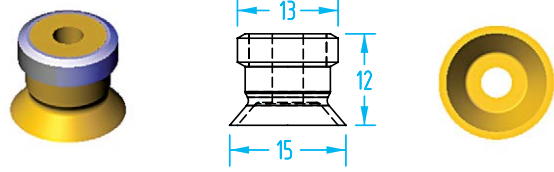

Cup Ø	Material	Quick#	Part#	Price
13mm	Silicone	2506	ZP13US	\$2.95
	Polyurethane	2540	ZP13UU	\$3.65
	Nitrile	2609	ZP13UN	\$2.70
	Anti-static	2687	ZP13UGS	\$4.30

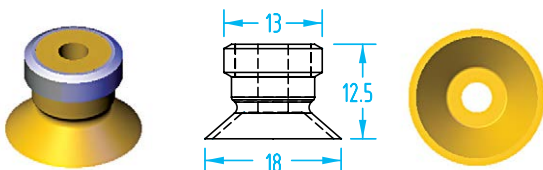

Cup Ø	Material	Quick#	Part#	Price
16mm	Silicone	2507	ZP16US	\$3.40
	Polyurethane	2541	ZP16UU	\$4.10
	Nitrile	2610	ZP16UN	\$3.15
	Anti-static	2688	ZP16UGS	\$4.75

Vacuum Cups

SMC® - Flat Smooth

(Shown Actual Size)

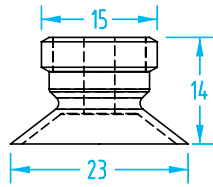
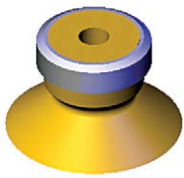

Cup Ø	Material	Quick#	Part#	Price
20mm	Silicone	2508	ZP20US	\$3.40
	Polyurethane	2542	ZP20UU	\$4.10
	Nitrile	2611	ZP20UN	\$3.15

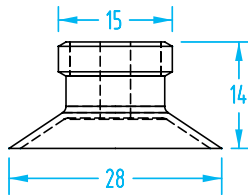
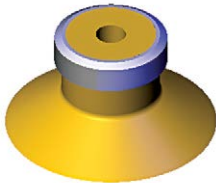

Cup Ø	Material	Quick#	Part#	Price
25mm	Silicone	2509	ZP25US	\$3.40
	Polyurethane	2543	ZP25UU	\$4.10
	Nitrile	2612	ZP25UN	\$3.15

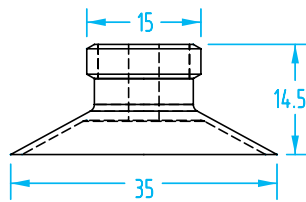
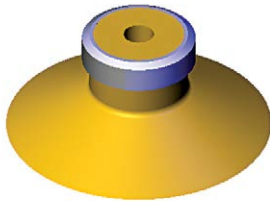

Cup Ø	Material	Quick#	Part#	Price
32mm	Silicone	2510	ZP32US	\$3.75
	Polyurethane	2544	ZP32UU	\$4.45
	Nitrile	2613	ZP32UN	\$3.40

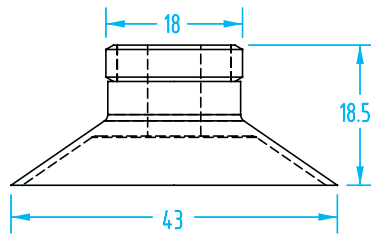
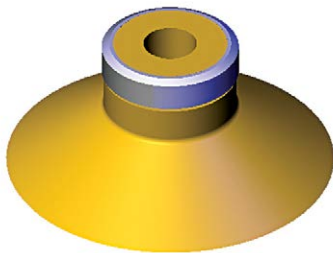

Cup Ø	Material	Quick#	Part#	Price
40mm	Silicone	2511	ZP40US	\$4.90
	Polyurethane	2545	ZP40UU	\$5.85
	Nitrile	2614	ZP40UN	\$4.45

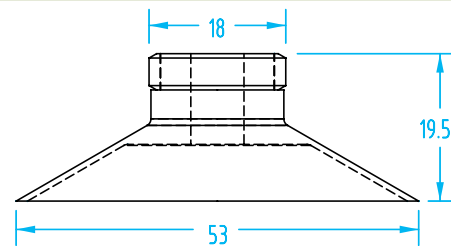
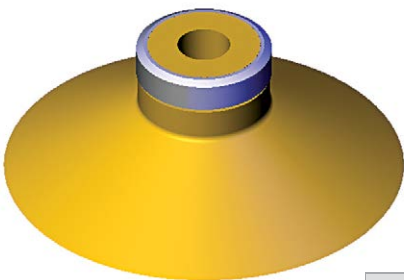

Cup Ø	Material	Quick#	Part#	Price
50mm	Silicone	2512	ZP50US	\$4.90
	Polyurethane	2546	ZP50UU	\$5.85
	Nitrile	2615	ZP50UN	\$4.45

SMC® - Flat Ribbed

(Shown Actual Size)



SMC Vacuum Cup Properties

Material	Color	Max Temp.	Durometer
Silicone	Semi-translucent white	392°F	40°
Polyurethane	Semi-translucent gold	140°F	60°
Nitrile	Black	180°F	50°

Order nipples separately, see page 265.

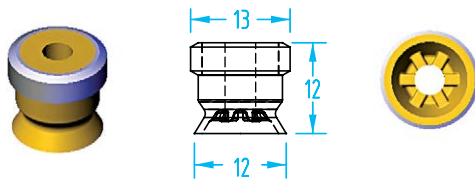

Cup Ø	Material	Quick#	Part#	Price
10mm	Silicone	2513	ZP10CS	\$2.95
	Polyurethane	2547	ZP10CU	\$3.65
	Nitrile	2616	ZP10CN	\$2.70

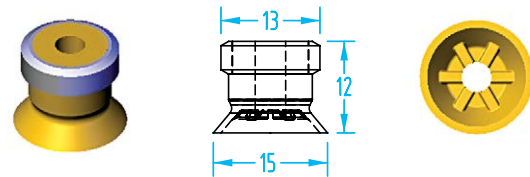

Cup Ø	Material	Quick#	Part#	Price
13mm	Silicone	2514	ZP13CS	\$2.95
	Polyurethane	2548	ZP13CU	\$3.65
	Nitrile	2617	ZP13CN	\$2.70

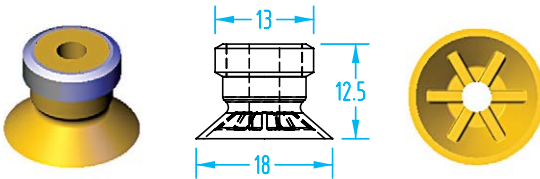

Cup Ø	Material	Quick#	Part#	Price
16mm	Silicone	2515	ZP16CS	\$3.40
	Polyurethane	2549	ZP16CU	\$4.10
	Nitrile	2618	ZP16CN	\$3.15

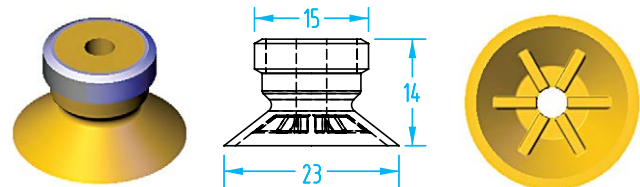

Cup Ø	Material	Quick#	Part#	Price
20mm	Silicone	2516	ZP20CS	\$3.40
	Polyurethane	2550	ZP20CU	\$4.10
	Nitrile	2619	ZP20CN	\$3.15



Cup Ø	Material	Quick#	Part#	Price
25mm	Silicone	2517	ZP25CS	\$3.40
	Polyurethane	2551	ZP25CU	\$4.10
	Nitrile	2620	ZP25CN	\$3.15

SMC® - Flat Ribbed

(Shown Actual Size)

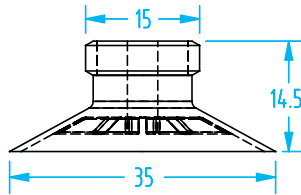
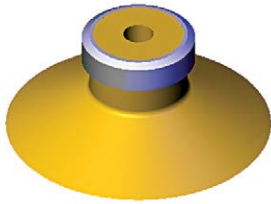

Cup Ø	Material	Quick#	Part#	Price
32mm	Silicone	2518	ZP32CS	\$3.75
	Polyurethane	2552	ZP32CU	\$4.45
	Nitrile	2621	ZP32CN	\$3.40

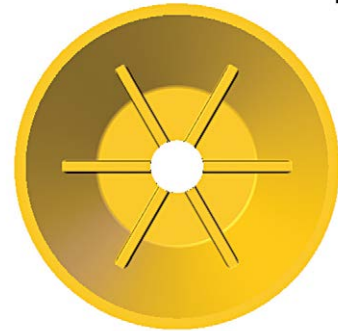
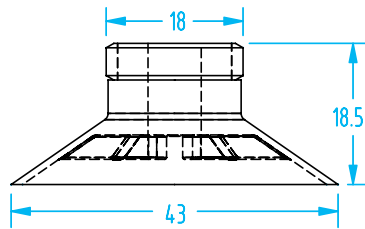
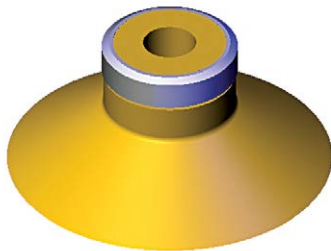

Cup Ø	Material	Quick#	Part#	Price
40mm	Silicone	2519	ZP40CS	\$4.90
	Polyurethane	2553	ZP40CU	\$5.85
	Nitrile	2637	ZP40CN	\$4.45

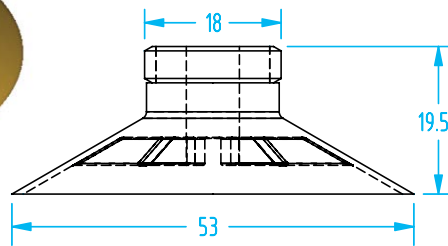
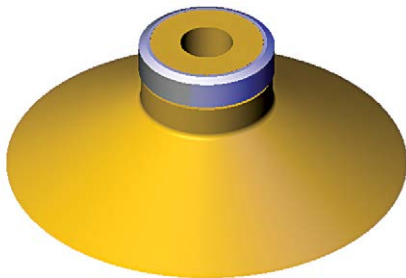

Cup Ø	Material	Quick#	Part#	Price
50mm	Silicone	2520	ZP50CS	\$4.90
	Polyurethane	2554	ZP50CU	\$5.85
	Nitrile	2622	ZP50CN	\$4.45

When ordering, use Quick#s to ensure order accuracy.

SMC® - 1.5 Bellows

(Shown Actual Size)

* 11mm Compressed

Cup Ø	Material	Quick#	Part#	Price
6mm	Silicone	2525	ZP06BS	\$4.25
	Polyurethane	2559	ZP06BU	\$4.60
	Nitrile	2625	ZP06BN	\$4.05
	Anti-static	2678	ZP06BGS	\$4.20

* 11mm Compressed

Cup Ø	Material	Quick#	Part#	Price
8mm	Silicone	2526	ZP08BS	\$4.25
	Polyurethane	2560	ZP08BU	\$4.60
	Nitrile	2624	ZP08BN	\$4.05
	Anti-static	2679	ZP08BGS	\$4.20

* 12mm Compressed

Cup Ø	Material	Quick#	Part#	Price
10mm	Silicone	2527	ZP10BS	\$5.35
	Polyurethane	2561	ZP10BU	\$5.95
	Nitrile	2654	ZP10BN	\$5.15
	Anti-static	2680	ZP10BGS	\$6.45

* 13mm Compressed

Cup Ø	Material	Quick#	Part#	Price
13mm	Silicone	2528	ZP13BS	\$5.35
	Polyurethane	2562	ZP13BU	\$5.95
	Nitrile	2623	ZP13BN	\$5.15
	Anti-static	2681	ZP13BGS	\$6.45

* 13mm Compressed

Cup Ø	Material	Quick#	Part#	Price
16mm	Silicone	2529	ZP16BS	\$5.75
	Polyurethane	2563	ZP16BU	\$6.30
	Nitrile	2626	ZP16BN	\$5.50
	Anti-static	2682	ZP16BGS	\$6.85

* 15mm Compressed

Cup Ø	Material	Quick#	Part#	Price
20mm	Silicone	2530	ZP20BS	\$5.75
	Polyurethane	2564	ZP20BU	\$6.30
	Nitrile	2627	ZP20BN	\$5.50

* 15mm Compressed

Cup Ø	Material	Quick#	Part#	Price
25mm	Silicone	2531	ZP25BS	\$5.75
	Polyurethane	2565	ZP25BU	\$6.30
	Nitrile	2628	ZP25BN	\$5.50

Vacuum Cups

SMC® - 1.5 Bellows

(Shown Actual Size)

Order nipples separately, see page 265.

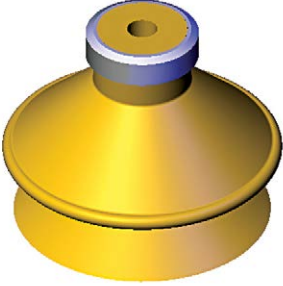

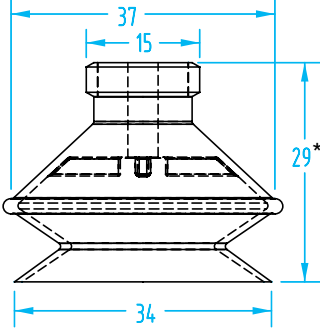



* 18mm Compressed

Cup Ø	Material	Quick#	Part#	Price
32mm	Silicone	2532	ZP32BS	\$7.10
	Polyurethane	2566	ZP32BU	\$7.70
	Nitrile	2629	ZP32BN	\$6.80

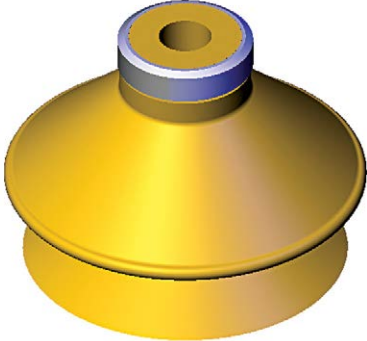

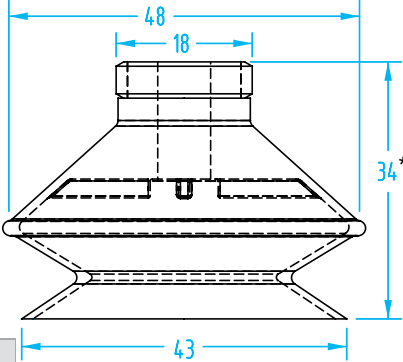

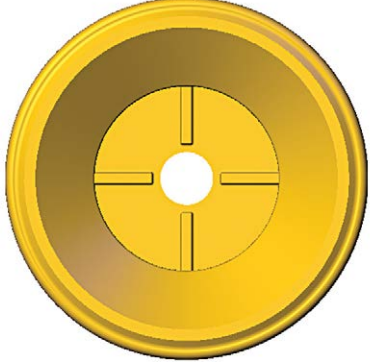

* 22mm Compressed

Cup Ø	Material	Quick#	Part#	Price
40mm	Silicone	2533	ZP40BS	\$9.15
	Polyurethane	2567	ZP40BU	\$9.95
	Nitrile	2630	ZP40BN	\$8.80

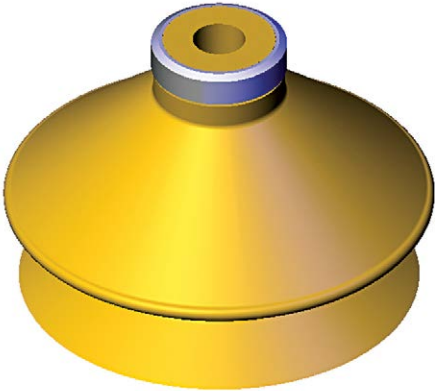

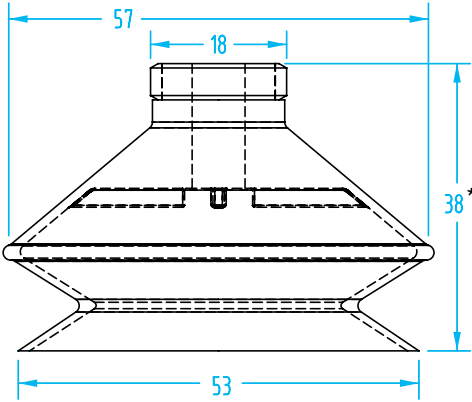

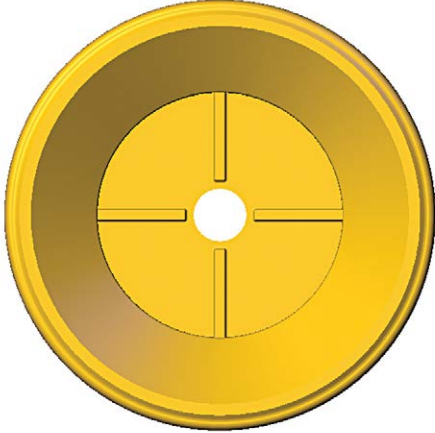

* 22mm Compressed

Cup Ø	Material	Quick#	Part#	Price
50mm	Silicone	2534	ZP50BS	\$9.15
	Polyurethane	2568	ZP50BU	\$9.95
	Nitrile	2631	ZP50BN	\$8.80

SMC® - Deep Cups

(Shown Actual Size)



SMC Vacuum Cup Properties

Material	Color	Max Temp.	Durometer
Silicone	Semi-translucent white	392°F	40°
Polyurethane	Semi-translucent gold	140°F	60°
Nitrile	Black	180°F	50°

When ordering, use Quick#s to ensure order accuracy.

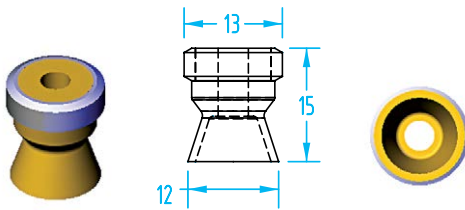

Cup Ø	Material	Quick#	Part#	Price
10mm	Silicone	2521	ZP10DS	\$6.30
	Polyurethane	2555	ZP10DU	\$7.00
	Nitrile	2632	ZP10DN	\$6.05

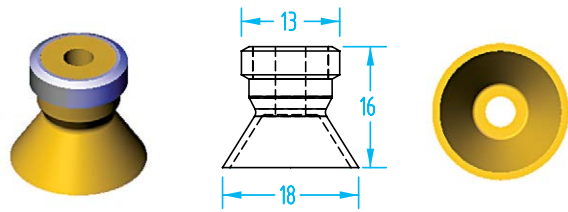

Cup Ø	Material	Quick#	Part#	Price
16mm	Silicone	2522	ZP16DS	\$6.65
	Polyurethane	2556	ZP16DU	\$7.35
	Nitrile	2633	ZP16DN	\$6.40

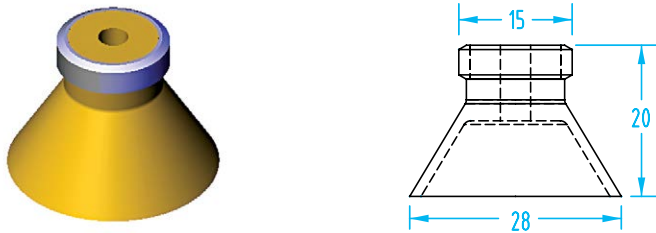

Cup Ø	Material	Quick#	Part#	Price
25mm	Silicone	2523	ZP25DS	\$6.65
	Polyurethane	2557	ZP25DU	\$7.35
	Nitrile	2634	ZP25DN	\$6.40

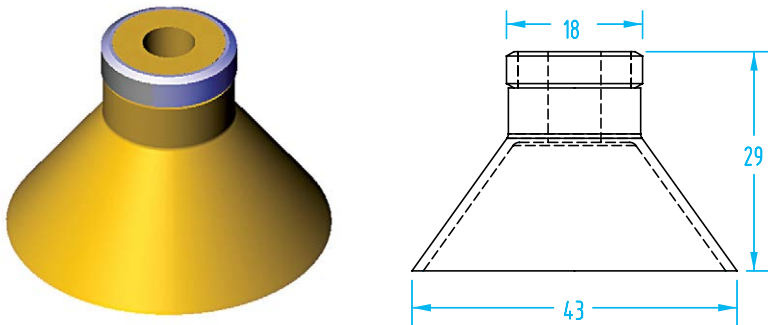

Cup Ø	Material	Quick#	Part#	Price
40mm	Silicone	2524	ZP40DS	\$3.85
	Polyurethane	2558	ZP40DU	\$4.80
	Nitrile	2635	ZP40DN	\$3.40

SMC® - Nipples and Adaptors

(Shown Actual Size)

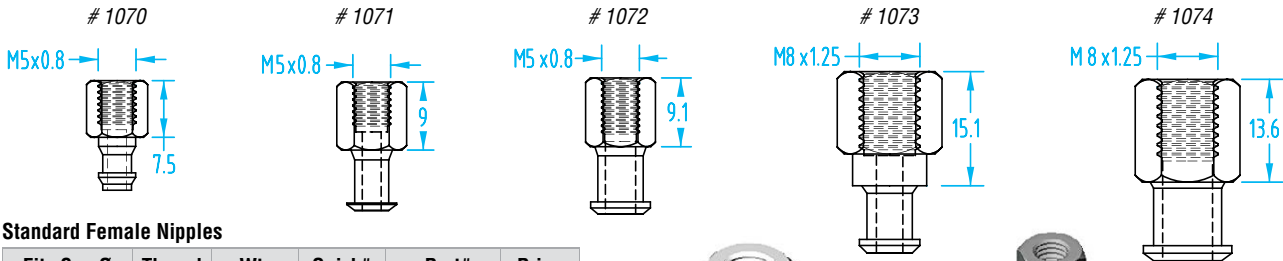

Standard Female Nipples

Fits Cup Ø	Thread	Wt.	Quick#	Part#	Price
2-8mm	M5	3g	1070	ZPT1B5	\$3.10
10-16mm	M5	4g	1071	ZPT2B5	\$6.15
20-32mm	M5	4g	1072	ZPT3B5	\$6.15
20-32mm	M8	12g	1073	ZPT3B8	\$6.15
40-50mm	M8	12g	1074	ZPT4B8	\$6.15



Shown with vacuum cup attached (typical)

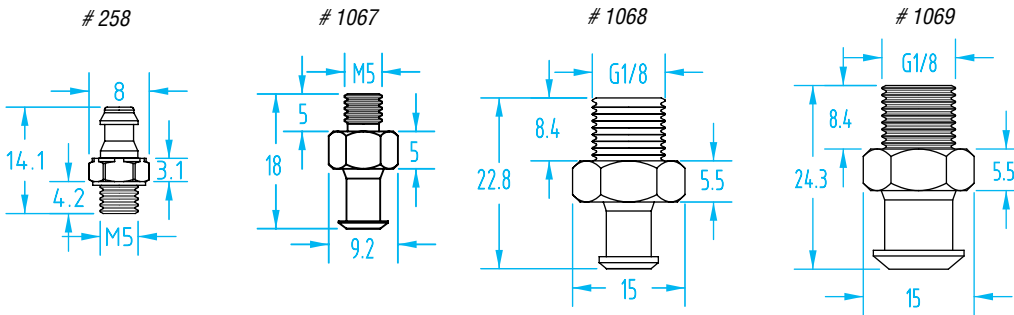

Standard Male Nipples

Fits Cup Ø	Thread	Wt.	Quick#	Part#	Price
2-8mm	M5	4g	258	GSF-BS-M506	\$0.78
10-16mm	M5	5g	1067	GSF-ZPT2-M5S	\$6.15
20-32mm	M8	13g	1089	ZPT3A8	\$6.15
20-32mm	G1/8"	13g	1068	GSF-ZPT3-G8	\$6.15
40-50mm	M8	13g	1090	ZPT4A8	\$6.15
40-50mm	G1/8"	13g	1069	GSF-ZPT4-G8	\$6.15

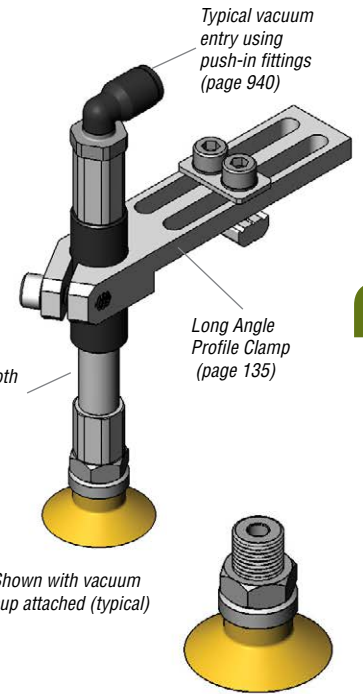
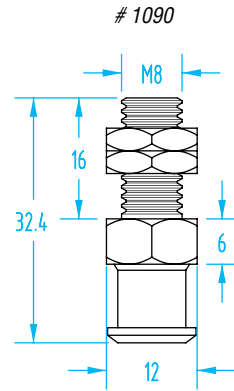

Typical vacuum entry using push-in fittings (page 940)

Long Angle Profile Clamp (page 135)

Gimatic Smooth Suspension (page 170)

Shown with vacuum cup attached (typical)

Vacuum Cups

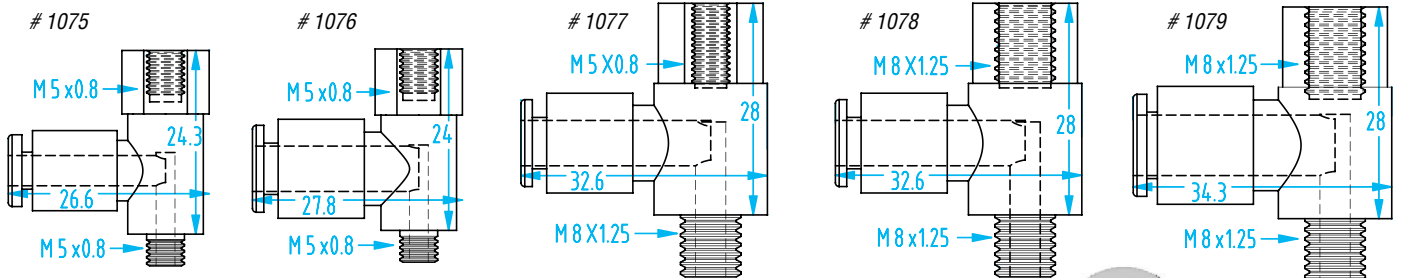

One-Touch Adaptor for Standard Nipples (use with standard polyurethane tubing)

Fits Cup Ø	Tubing Dia.	Thread	Wt.	Quick#	Part#	Price
2-16mm	Ø 4mm	M5	12g	1075	ZPRS04B5	\$12.80
2-16mm	Ø 6mm	M5	14g	1076	ZPRS06B5	\$12.80
20-32mm	Ø 6mm	M5	24g	1077	ZPRL06B5	\$13.80
20-50mm	Ø 6mm	M8	24g	1078	ZPRL06B8	\$13.80
20-50mm	Ø 8mm	M8	24g	1079	ZPRL08B8	\$13.80

See page 266 for typical assembly styles.



Screws into standard nipples (above)

SMC® - Spring Loaded Suspensions

(Shown Actual Size)

Suspensions (with Internal Springs)

Style	Size	Weight	Quick#	Part#	Price
Standard	Small	20g	336	GSS-53-M10M5	\$19.75
Non-rotate		20g	337	GSS-53R-M10M5	\$22.34
Standard	Large	68g	339	GSS-88-M14M5	\$18.39
Non-rotate		68g	340	GSS-88R-M14M5	\$28.69
Standard	Medium	26g	2569	GSS-80-M10M5	\$23.64
Non-rotate		26g	2571	GSS-80R-M10M5	\$33.92
Standard	Long	32g	443	GSS-99-M10M5	\$24.68
Non-rotate		32g	1870	GSS-99R-M10M5	\$34.96

More SMC Suspensions on page 166.

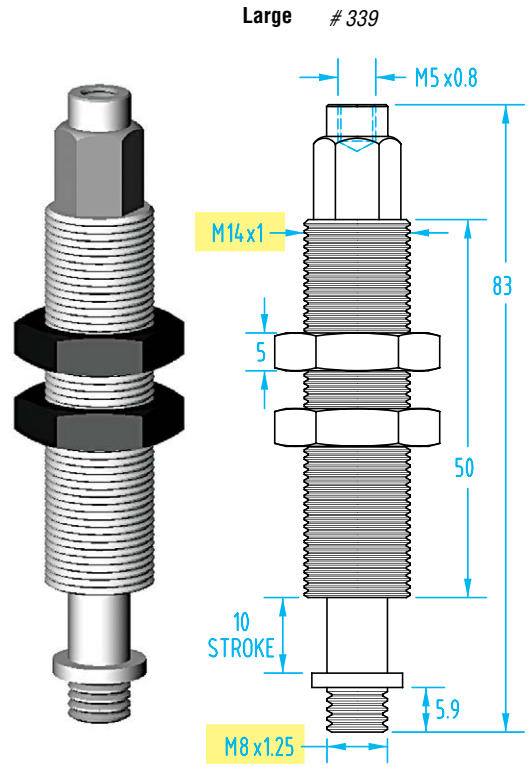
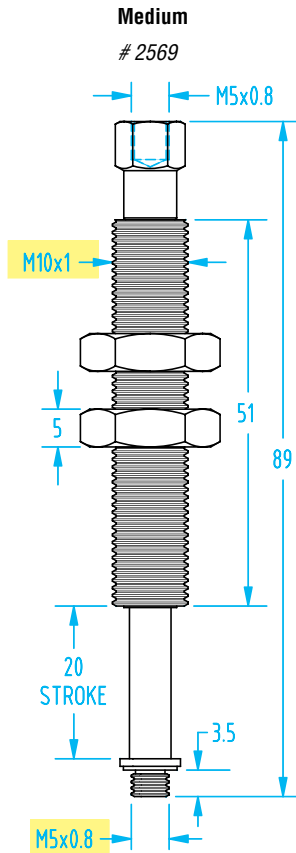
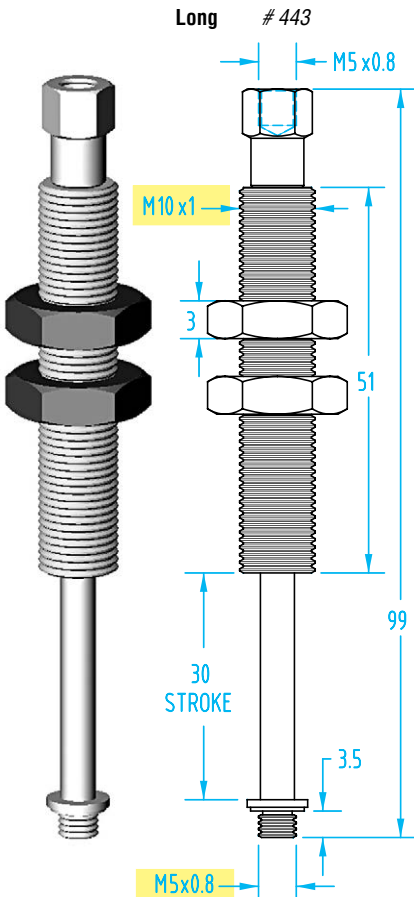
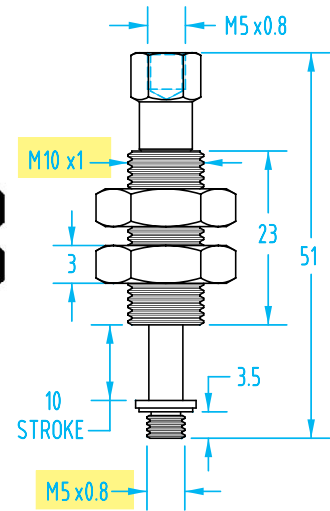
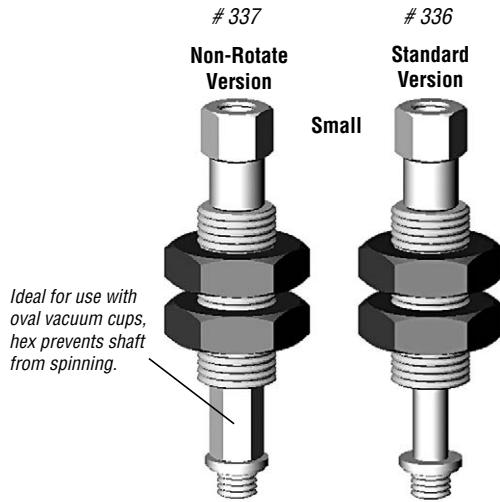
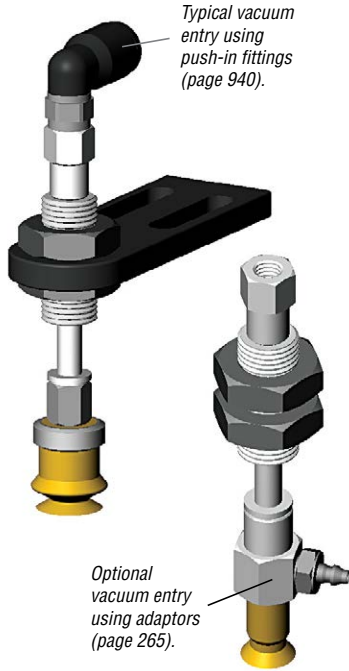

Mounting Brackets for SMC®

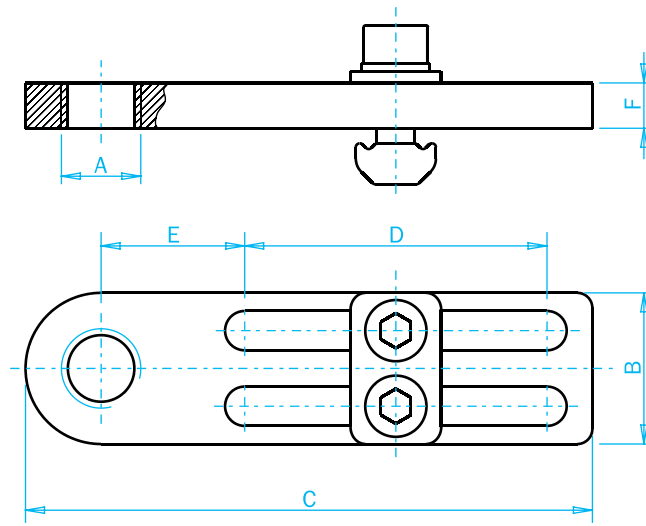

Slotted Mounting Bracket (anodized aluminum)

Quick#	Part#	Price	A	Type	B	C	D	E	F	Wt.
5668	MFI-A106	\$9.07	M10x1	Short	20	75	40	19	6	30g
5669	MFI-A107	\$9.94	M10x1	Long	25	105	60	26.5	6	40g
5670	MFI-A108	\$9.07	M14x1	Short	20	75	40	19	6	20g
5671	MFI-A109	\$9.94	M14x1	Long	25	105	60	26.5	6	40g

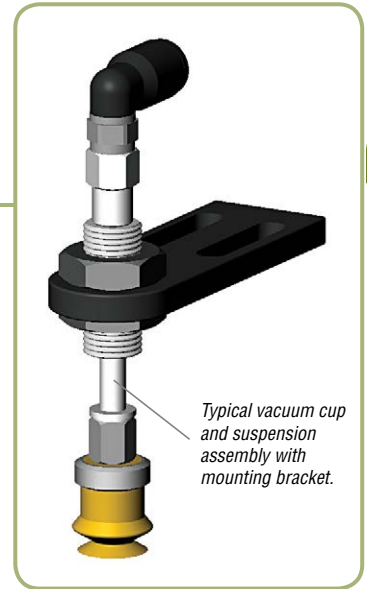

Vacuum Cups

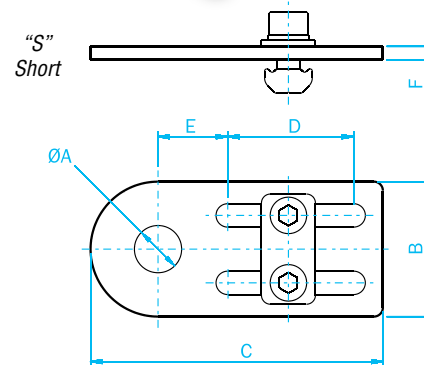
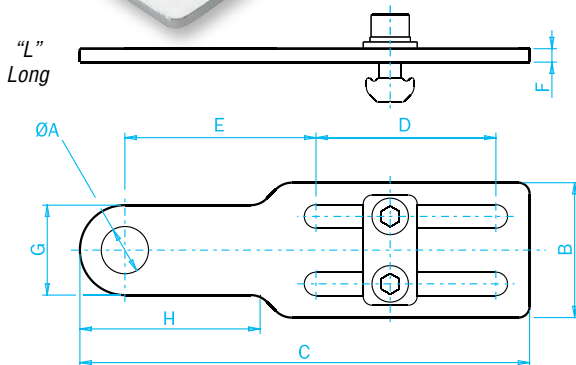

Slotted Mounting Bracket (economy version - steel)

Quick#	Part#	Price	Type	ØA	B	C	D	E	F	G	H	Wt.
5678	MFI-A116	\$8.86	L	10.5	30	100	40	42.5	3	20	38	60g
5680	MFI-A118	\$8.86	L	14.5	30	100	40	42.5	3	24	38	60g
5683	MFI-A121	\$7.99	S	10.5	30	65	28	15.5	3	-	-	45g
5685	MFI-A123	\$7.99	S	14.5	30	65	28	15.5	3	-	-	45g

More Sizes Available on page 130



Fittings Available on page 935



Gimatic® - Flat

(Shown Actual Size)



- Two styles: flat or with 1.5 bellows.
- Four materials: Silicone, EPDM, HNBR, & Natural Rubber.
- New non-marking HNBR material has a higher temperature range.
- Call EMI or visit our website for natural rubber cups.
- Diameter from 11mm to 53mm.
- See page 272 for nipple dimensions.

Gimatic Vacuum Cup Properties

Material	Color	Max Temp.	Durometer
Silicone	Red	392°F	55°
EPDM	Black	212° F	48°
HNBR	Blue	302° F	60°
Natural Rubber	Green	176°F	53°



Vacuum Cups

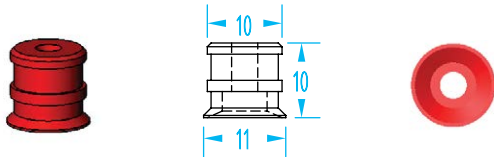

Cup Ø	Quick#	Part#	Reference	Price
11mm	5785	V0111S01	SIL	\$2.23
	5786	V0111E02	EPDM	\$2.00
	2019	V0111H04	HNBR	\$2.93
Nipple	5821	AV01M5F08	Female M5	\$1.90
	5822	AV01M5M08	Male M5	\$1.94
	5825	AV0118F16	Female G1/8"	\$4.08
	5826	AV0118M13	Male G1/8"	\$5.12

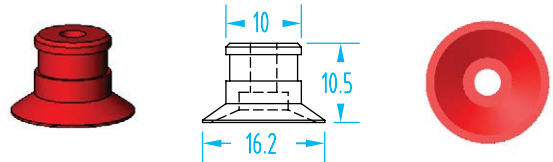

Cup Ø	Quick#	Part#	Reference	Price
16mm	5788	V0116S01	SIL	\$2.26
	5789	V0116E02	EPDM	\$2.05
	2020	V0116H04	HNBR	\$3.07
Nipple	5821	AV01M5F08	Female M5	\$1.90
	5822	AV01M5M08	Male M5	\$1.94
	5825	AV0118F16	Female G1/8"	\$4.08
	5826	AV0118M13	Male G1/8"	\$5.12

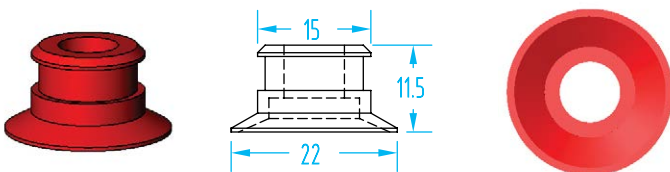

Cup Ø	Quick#	Part#	Reference	Price
22mm	5791	V0122S01	SIL	\$2.35
	5792	V0122E02	EPDM	\$2.09
	2021	V0122H04	HNBR	\$3.49
Nipple	5823	AV0118F12	Female G1/8"	\$1.97
	5824	AV0118M12	Male G1/8"	\$2.05
	5827	AV0118F16	Female G1/8"	\$2.35
	5828	AV0118M16	Male G1/8"	\$2.44

Gimatic® - Flat

(Shown Actual Size)

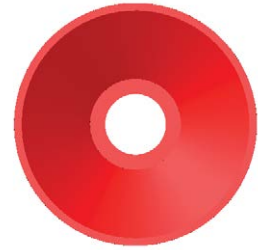
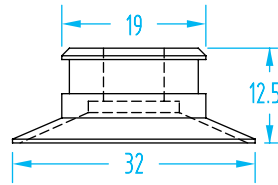
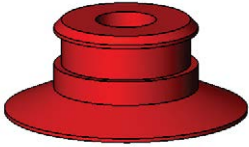

Cup Ø	Quick#	Part#	Reference	Price
33mm	5794	V0133S01	SIL	\$2.51
	5795	V0133E02	EPDM	\$2.19
	2022	V0133H04	HNBR	\$3.49
Nipple	5823	AV0118F12	Female G1/8"	\$1.97
	5824	AV0118M12	Male G1/8"	\$2.05
	5827	AV0118F16	Female G1/8"	\$2.35
	5828	AV0118M16	Male G1/8"	\$2.44
	5829	AV0114F16	Female G1/4"	\$2.35
	5830	AV0114M16	Male G1/4"	\$2.46

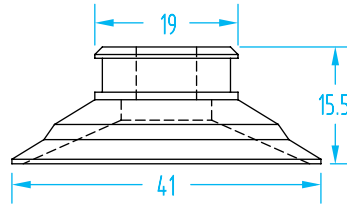
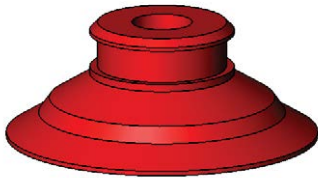

Cup Ø	Quick#	Part#	Reference	Price
42mm	5797	V0142S01	SIL	\$3.58
	5798	V0142E02	EPDM	\$2.91
	2023	V0142H04	HNBR	\$5.58
Nipple	5823	AV0118F12	Female G1/8"	\$1.97
	5824	AV0118M12	Male G1/8"	\$2.05
	5827	AV0118F16	Female G1/8"	\$2.35
	5828	AV0118M16	Male G1/8"	\$2.44
	5829	AV0114F16	Female G1/4"	\$2.35
	5830	AV0114M16	Male G1/4"	\$2.46

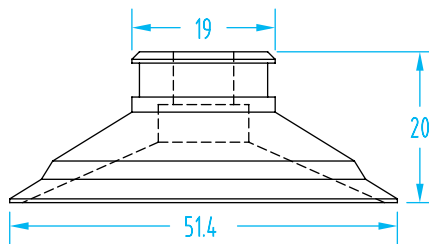
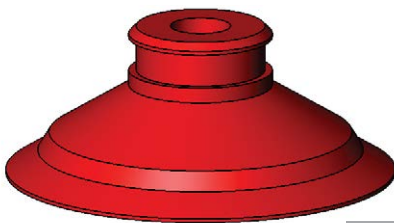

Cup Ø	Quick#	Part#	Reference	Price
53mm	5800	V0153S01	SIL	\$4.07
	5801	V0153E02	EPDM	\$3.03
	2024	V0153H04	HNBR	\$5.72
Nipple	5823	AV0118F12	Female G1/8"	\$1.97
	5824	AV0118M12	Male G1/8"	\$2.05
	5827	AV0118F16	Female G1/8"	\$2.35
	5828	AV0118M16	Male G1/8"	\$2.44
	5829	AV0114F16	Female G1/4"	\$2.35
	5830	AV0114M16	Male G1/4"	\$2.46

Gimatic® - 1.5 Bellows

(Shown Actual Size)



Gimatic Vacuum Cup Properties

Material	Color	Max Temp.	Durometer
Silicone	Red	392°F	55°
EPDM	Black	212° F	48°
HNBR	Blue	302° F	60°
Natural Rubber	Green	176° F	53°

See page 272 for nipple dimensions.

* 11.2mm Compressed

Cup Ø	Quick#	Part#	Reference	Price
11mm	5803	V0211S01	SIL	\$4.03
	5804	V0211E02	EPDM	\$3.16
	2025	V0211H04	HNBR	\$4.75
Nipple	5821	AV01M5F08	Female M5	\$1.90
	5822	AV01M5M08	Male M5	\$1.94
	5825	AV0118F16	Female G1/8"	\$4.08
	5826	AV0118M13	Male G1/8"	\$5.12

* 14mm Compressed

Cup Ø	Quick#	Part#	Reference	Price
16mm	5806	V0216S01	SIL	\$4.07
	5807	V0216E02	EPDM	\$3.19
	2026	V0216H04	HNBR	\$4.75
	Nipple	5821	AV01M5F08	Female M5
5822		AV01M5M08	Male M5	\$1.94
5825		AV0118F16	Female G1/8"	\$4.08
5826		AV0118M13	Male G1/8"	\$5.12

* 12mm Compressed

Cup Ø	Quick#	Part#	Reference	Price
22mm	5809	V0222S01	SIL	\$4.19
	5810	V0222E02	EPDM	\$3.33
	2027	V0222H04	HNBR	\$7.40
Nipple	5821	AV01M5F08	Female M5	\$1.90
	5822	AV01M5M08	Male M5	\$1.94
	5825	AV0118F16	Female G1/8"	\$4.08
	5826	AV0118M13	Male G1/8"	\$5.12

* 15mm Compressed

Cup Ø	Quick#	Part#	Reference	Price
33mm	5812	V0233S01	SIL	\$5.54
	5813	V0233E02	EPDM	\$3.96
	2028	V0233H04	HNBR	\$7.54
Nipple	5823	AV0118F12	Female G1/8"	\$1.97
	5824	AV0118M12	Male G1/8"	\$2.05
	5827	AV0118F16	Female G1/8"	\$2.35
	5828	AV0118M16	Male G1/8"	\$2.44
	5829	AV0114F16	Female G1/4"	\$2.35
	5830	AV0114M16	Male G1/4"	\$2.46

Vacuum Cups

Gimatic® - 1.5 Bellows

(Shown Actual Size)

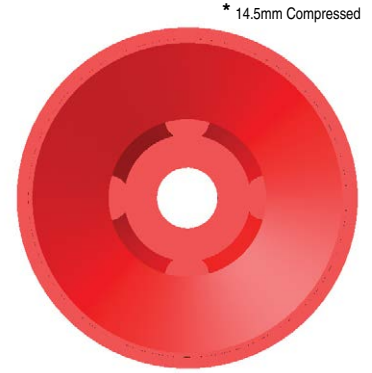
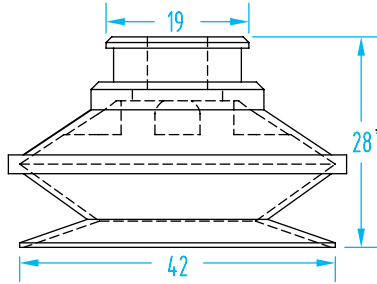
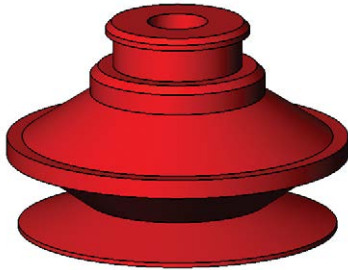

Cup Ø	Quick#	Part#	Reference	Price
42mm	5815	V0242S01	SIL	\$6.03
	5816	V0242E02	EPDM	\$4.70
	2029	V0242H04	HNBR	\$10.33
Nipple	5823	AV0118F12	Female G1/8"	\$1.97
	5824	AV0118M12	Male G1/8"	\$2.05
	5827	AV0118F16	Female G1/8"	\$2.35
	5828	AV0118M16	Male G1/8"	\$2.44
	5829	AV0114F16	Female G1/4"	\$2.35
	5830	AV0114M16	Male G1/4"	\$2.46

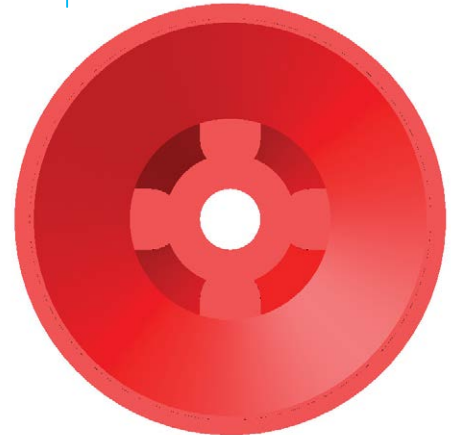
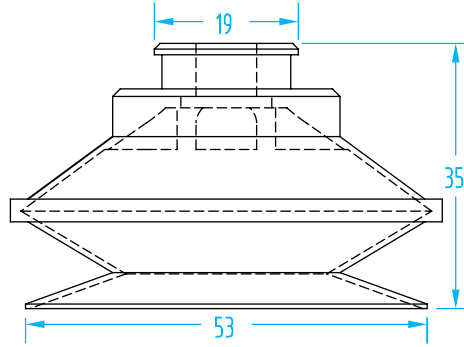
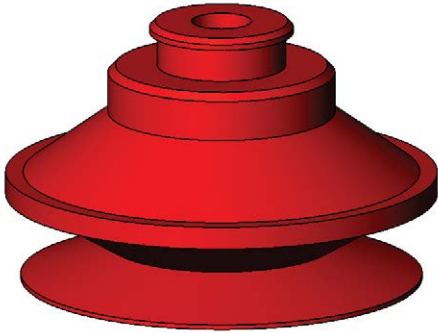

Cup Ø	Quick#	Part#	Reference	Price
53mm	5818	V0253S01	SIL	\$8.52
	5819	V0253E02	EPDM	\$6.14
	2030	V0253H04	HNBR	\$10.75
Nipple	5823	AV0118F12	Female G1/8"	\$1.97
	5824	AV0118M12	Male G1/8"	\$2.05
	5827	AV0118F16	Female G1/8"	\$2.35
	5828	AV0118M16	Male G1/8"	\$2.44
	5829	AV0114F16	Female G1/4"	\$2.35
	5830	AV0114M16	Male G1/4"	\$2.46

Gimatic® - Nipples

(Shown Actual Size)

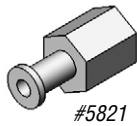
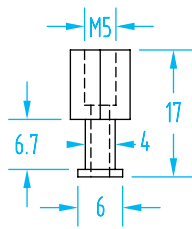

#5821

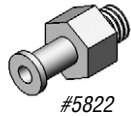
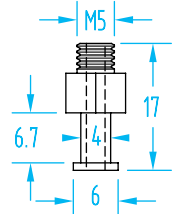

#5822

Thread	Quick#	Part#	Price
Female M5	5821	AV01M5F08	\$1.90
Male M5	5822	AV01M5M08	\$1.94

For: Vacuum Cup Ø11mm–22mm from pages 268–270

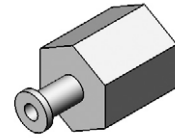
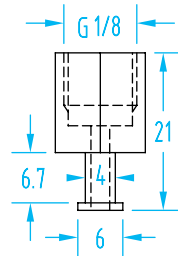

#5825

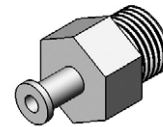
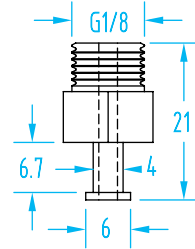

#5826

Thread	Quick#	Part#	Price
Female G1/8"	5825	AV0118F13	\$4.08
Male G1/8"	5826	AV0118M13	\$5.12

For: Vacuum Cup Ø11mm–22mm from pages 268–270

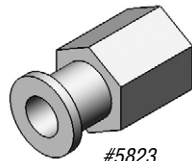
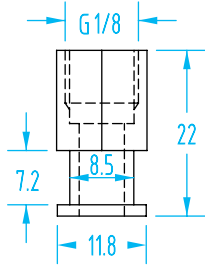

#5823

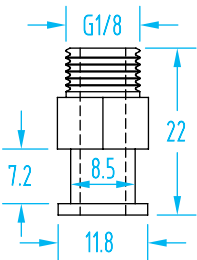

#5824

Thread	Quick#	Part#	Price
Female G1/8"	5823	AV0118F12	\$1.97
Male G1/8"	5824	AV0118M12	\$2.05

For: Vacuum Cup Ø23–53mm from pages 268–271

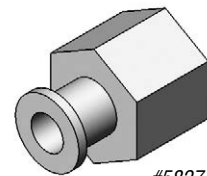
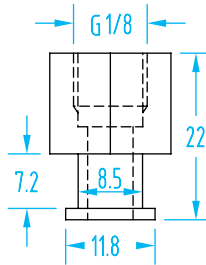

#5827

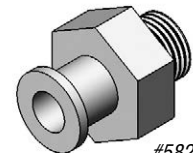
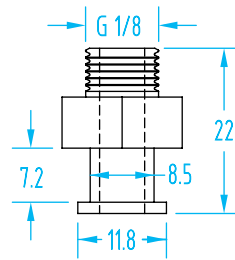

#5828

Thread	Quick#	Part#	Price
Female G1/8"	5827	AV0118F16	\$2.35
Male G1/8"	5828	AV0118M16	\$2.44

For: Vacuum Cup Ø23–53mm from pages 268–271

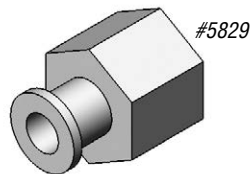
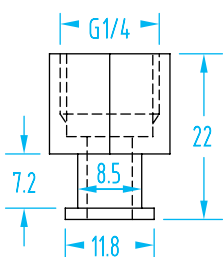

#5829

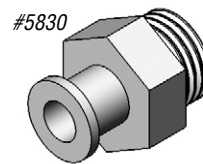

#5830

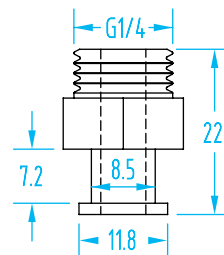

Material	Quick#	Part#	Price
Female G1/4"	5829	AV0114F16	\$2.35
Male G1/4"	5830	AV0114M16	\$2.46

For: Vacuum Cup Ø23mm–53mm from pages 268–271

Long Neck Silicone

(Shown Actual Size)



These elastic long-neck vacuum cups have a dedicated following of users. The long neck extends the reach of the cup beyond the congestion of the fitting, suspension, and tubing. The neck is slightly more flexible than standard flat cups.

Long Neck Extra Elastic Vacuum Cup Properties

Material	Color	Max Temp.	Durometer
Silicone	Semi-translucent white	392°F	40°

Quick#	Part#	Pad øD	OAL	Price
444	GSV-LES-6	6mm	12	\$6.05
Nipple				
445	GSF-N24-M5M	Male M5		\$5.96

Quick#	Part#	Pad øD	OAL	Price
446	GSV-LES-10	10mm	13	\$6.05
Nipple				
447	GSF-N25-M5M	Male M5		\$5.96

Quick#	Part#	Pad øD	OAL	Price
448	GSV-LES-16	16mm	20	\$6.70
Nipple				
449	GSF-N26-M5M	Male M5		\$5.96

Quick#	Part#	Pad øD	OAL	Price
450	GSV-LES-25	25mm	30	\$7.82
Nipple				
451	GSF-N27-G8M	Male G1/8"		\$6.06

Vacuum Cups

One-Nipple-Size-Fits-All

(Shown Actual Size)

**One nipple size, five thread options.
All vacuum cups on these two pages use the same nipple size!**



One-Nipple-Size-Fits-All Vacuum Cup Properties

Material	Color	Max Temp.	Durometer
Silicone	Semi-translucent white	392°F	50°
Polyurethane	Blue	176°F	55°

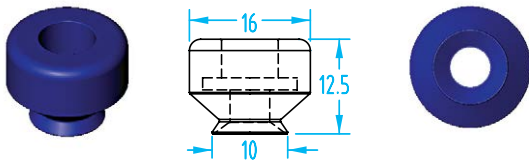

Cup Ø	Material	Quick#	Part#	Price
10mm	Silicone	345	GSV-FS-10	\$4.00
	Polyurethane	1550	GSV-FP-10	\$7.40

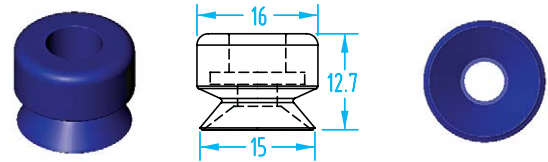

Cup Ø	Material	Quick#	Part#	Price
15mm	Silicone	346	GSV-FS-15	\$4.20
	Polyurethane	1551	GSV-FP-15	\$7.90

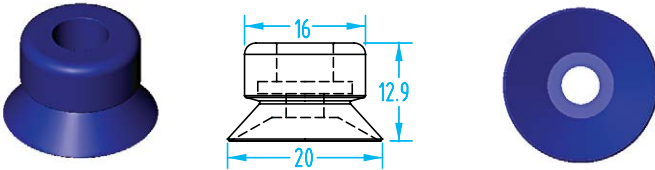

Cup Ø	Material	Quick#	Part#	Price
20mm	Silicone	347	GSV-FS-20	\$4.50
	Polyurethane	1552	GSV-FP-20	\$8.20

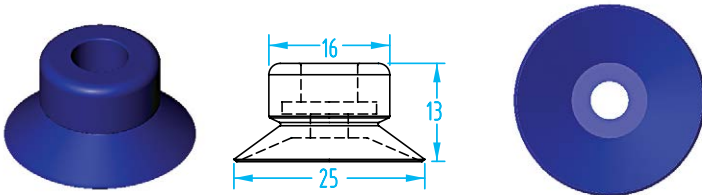

Cup Ø	Material	Quick#	Part#	Price
25mm	Silicone	348	GSV-FS-25	\$4.70
	Polyurethane	1553	GSV-FP-25	\$8.40

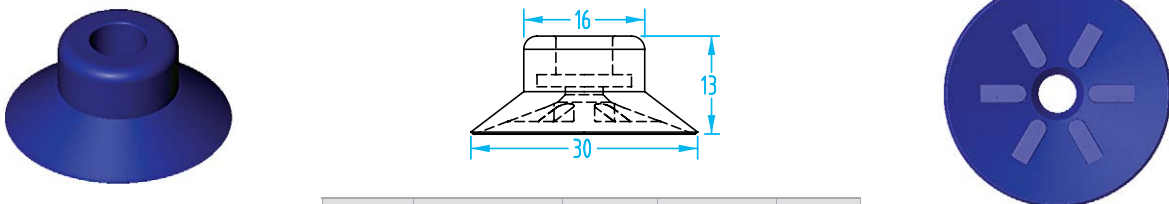

Cup Ø	Material	Quick#	Part#	Price
30mm	Silicone	349	GSV-FS-30	\$5.00
	Polyurethane	1554	GSV-FP-30	\$8.90

Vacuum Cups

One-Nipple-Size-Fits-All

(Shown Actual Size)

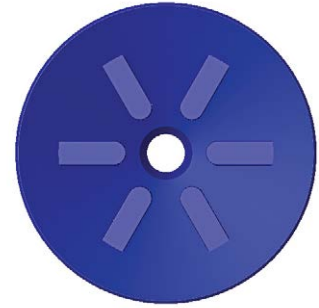
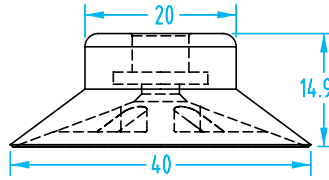
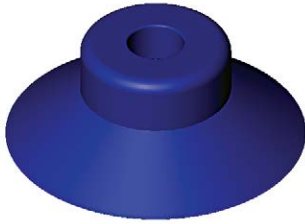

Cup Ø	Material	Quick#	Part#	Price
40mm	Silicone	350	GSV-FS-40	\$5.90
	Polyurethane	1555	GSV-FP-40	\$11.10

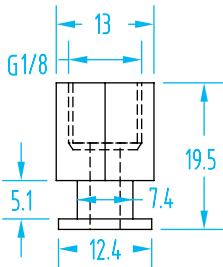

Nipples

Quick#	Part#	Nipple	Thread	Pad øD	Price
325	GSF-VPN-M5	Male	M5	5-50mm	\$2.00
326	GSF-VPN-G8	Male-Female	G1/8"-M5	5-50mm	\$2.50
343	GSF-VPN-G8F	Female	G1/8"	5-50mm	\$4.84
344	GSF-VPN-M8F	Female	M8	5-50mm	\$4.84

All vacuum cups on these two pages fit these integrated nipple suspensions.

Suspensions

Quick#	Part#	Stroke	Weight	Price
332	GSS-65N-M10M5	10mm	41g	\$21.00
456	GSS-65N-G8M5	10mm	39g	\$21.00
1823	GSS-75L-M16N	20mm	20g	\$23.78



New, improved with smoother quality operation



Vacuum Cups

One-Nipple-Size-Fits-All

(Shown Actual Size)

**One nipple size, five thread options.
All vacuum cups on these two pages use the same nipple size!**



One-Nipple-Size-Fits-All Vacuum Cup Properties

Material	Color	Max Temp.	Durometer
Silicone	Semi-translucent white	392°F	50°
Polyurethane	Blue	176°F	55°

These cups are also available with a foam sealing surface for textured parts, see page 289.

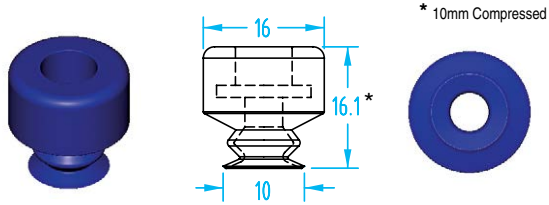

* 10mm Compressed

Cup Ø	Material	Quick#	Part#	Price
10mm	Silicone	353	GSV-BS-10	\$6.40
	Polyurethane	1558	GSV-BP-10	\$9.70

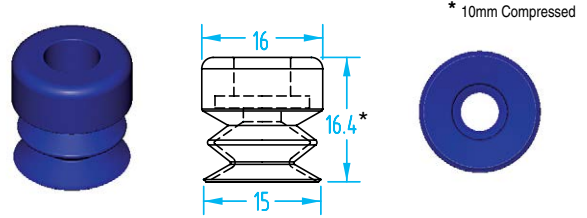

* 10mm Compressed

Cup Ø	Material	Quick#	Part#	Price
15mm	Silicone	354	GSV-BS-15	\$7.40
	Polyurethane	1559	GSV-BP-15	\$10.40

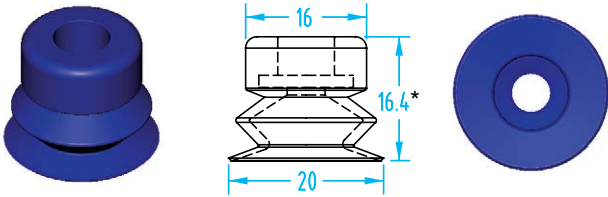

* 10mm Compressed

Cup Ø	Material	Quick#	Part#	Price
20mm	Silicone	355	GSV-BS-20	\$8.70
	Polyurethane	1560	GSV-BP-20	\$10.70

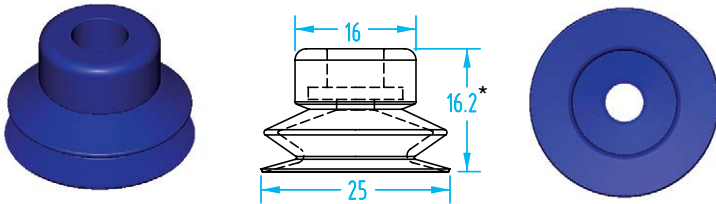

* 10mm Compressed

Cup Ø	Material	Quick#	Part#	Price
25mm	Silicone	356	GSV-BS-25	\$9.20
	Polyurethane	1561	GSV-BP-25	\$14.10

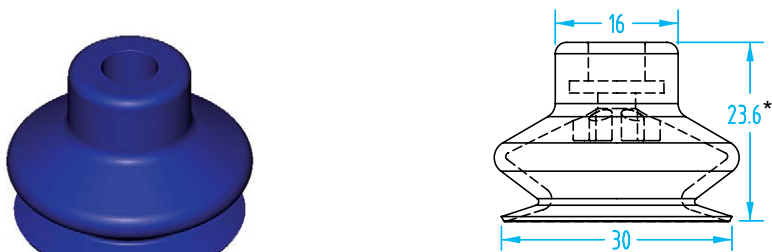

* 16mm Compressed

Cup Ø	Material	Quick#	Part#	Price
30mm	Silicone	357	GSV-BS-30	\$9.90
	Polyurethane	1562	GSV-BP-30	\$19.30

Vacuum Cups

One-Nipple-Size-Fits-All

(Shown Actual Size)

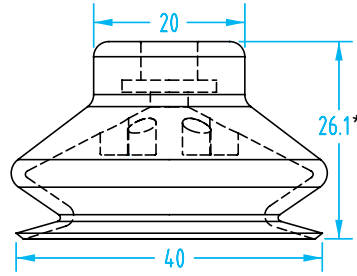

* 19mm Compressed

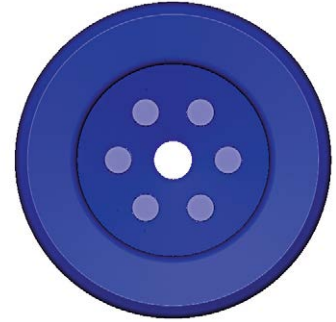

Cup Ø	Material	Quick#	Part#	Price
40mm	Silicone	358	GSV-BS-40	\$10.70
	Polyurethane	1563	GSV-BP-40	\$23.00

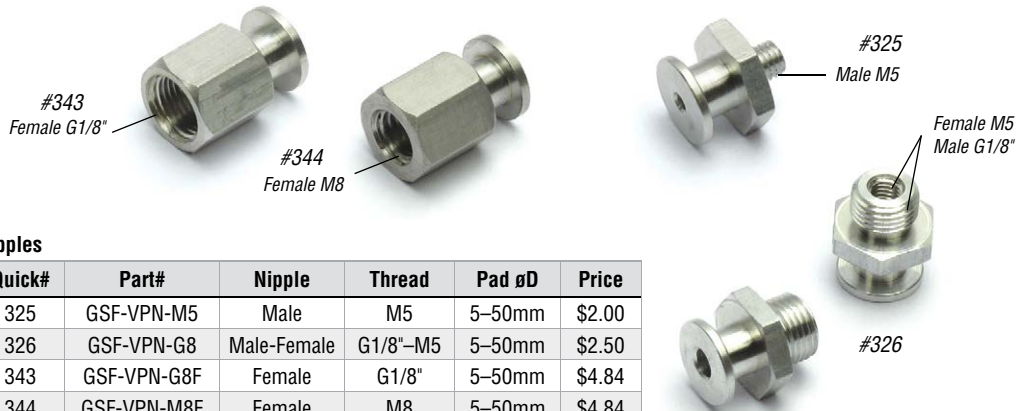
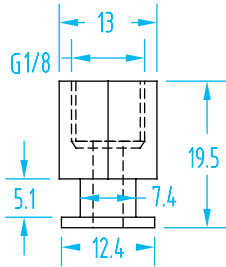

Nipples

Quick#	Part#	Nipple	Thread	Pad øD	Price
325	GSF-VPN-M5	Male	M5	5-50mm	\$2.00
326	GSF-VPN-G8	Male-Female	G1/8"-M5	5-50mm	\$2.50
343	GSF-VPN-G8F	Female	G1/8"	5-50mm	\$4.84
344	GSF-VPN-M8F	Female	M8	5-50mm	\$4.84

All vacuum cups on these two pages fit these integrated nipple suspensions.

Suspensions

Quick#	Part#	Stroke	Weight	Price
332	GSS-65N-M10M5	10mm	41g	\$21.00
456	GSS-65N-G8M5	10mm	39g	\$21.00
1823	GSS-75L-M16N	20mm	20g	\$23.78



New, improved with smoother quality operation



Vacuum pad #355

Plug #238 (page 958)

Vacuum Cups

Apex® - One-Nipple-Size-Fits-All

(Shown Actual Size)



Vacuum Cup Properties

Material	Color	Max Temp.	Durometer
Silicone	Semi-translucent white	392°F	50°

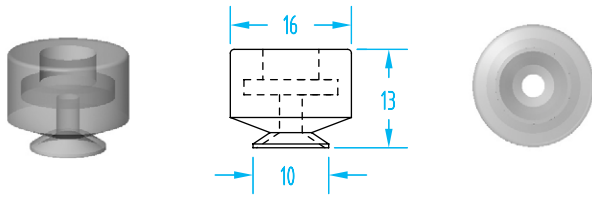

Quick#	Part#	Pad øD	Price
1885	GSV-FSAX-10	10mm	\$3.13

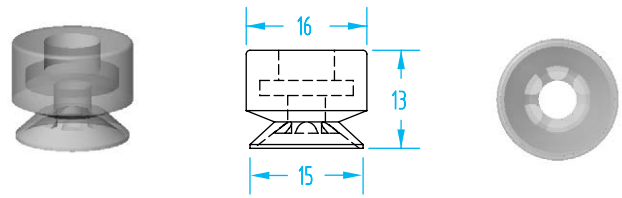

Quick#	Part#	Pad øD	Price
1886	GSV-FSAX-15	15mm	\$3.13

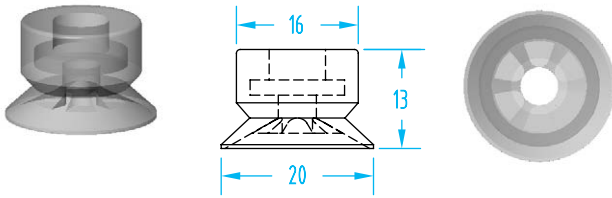

Quick#	Part#	Pad øD	Price
1887	GSV-FSAX-20	20mm	\$3.13

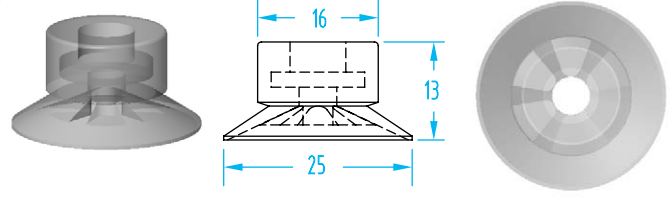

Quick#	Part#	Pad øD	Price
1888	GSV-FSAX-25	25mm	\$3.13

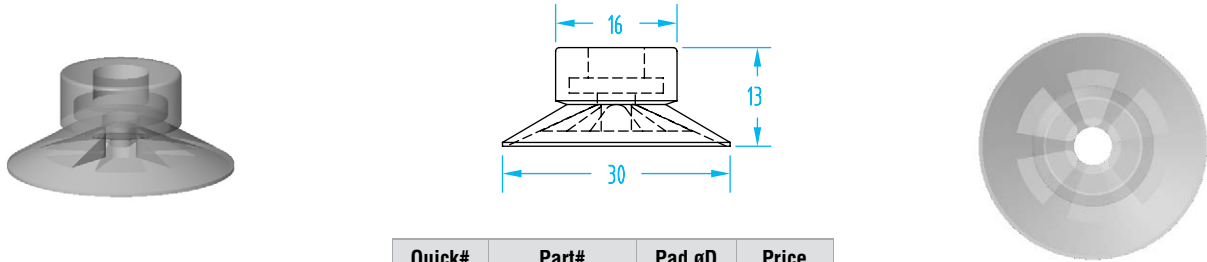

Quick#	Part#	Pad øD	Price
1889	GSV-FSAX-30	30mm	\$3.67

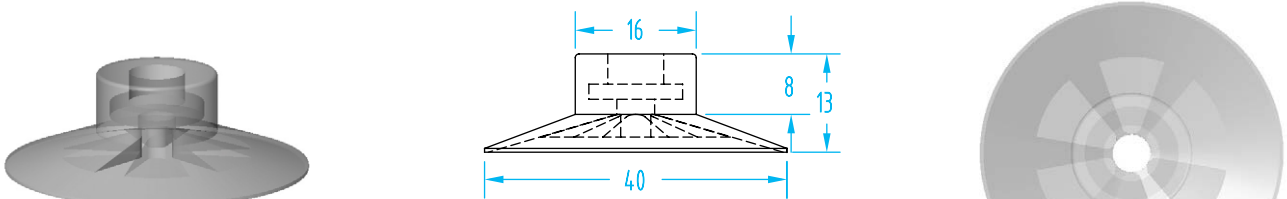

Quick#	Part#	Pad øD	Price
1890	GSV-FSAX-40	40mm	\$3.67

Apex® - One-Nipple-Size-Fits-All

(Shown Actual Size)

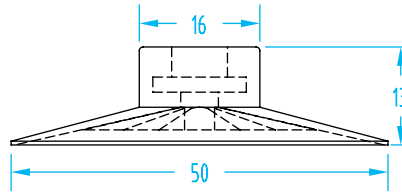
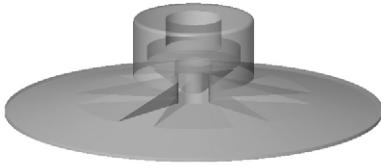

Quick#	Part#	Pad øD	Price
1891	GSV-FSAX-50	50mm	\$4.20

**One nipple size, five thread options.
All vacuum cups on these two pages use the same nipple size!**

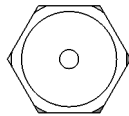
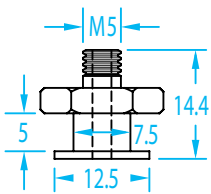

#326
Female M5
Male G1/8"

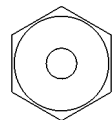
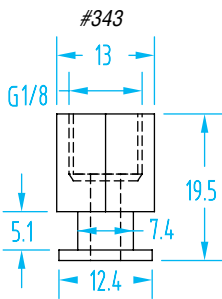
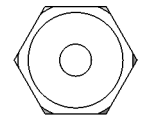
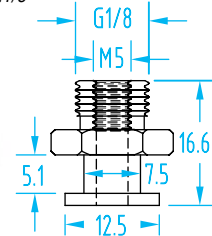

#343
Female G1/8"



#344
Female M8

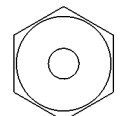
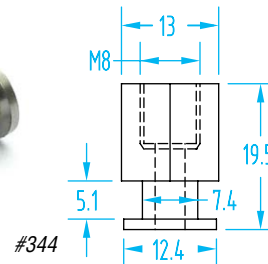

Nipples

Quick#	Part#	Nipple	Thread	Pad øD	Price
325	GSF-VPN-M5	Male	M5	5-50mm	\$2.00
326	GSF-VPN-G8	Male-Female	G1/8"-M5	5-50mm	\$2.50
343	GSF-VPN-G8F	Female	G1/8"	5-50mm	\$4.84
344	GSF-VPN-M8F	Female	M8	5-50mm	\$4.84

Fittings Available
on page 935



Apex® - One-Nipple-Size-Fits-All

(Shown Actual Size)



Apex Vacuum Cup Properties

Material	Color	Max Temp.	Durometer
Silicone	Semi-translucent white	392°F	50°

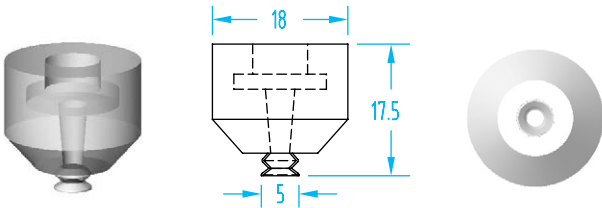

Pad øD	Part#	Quick#	Price
5mm	GSV-BSAX-05	1892	\$4.20

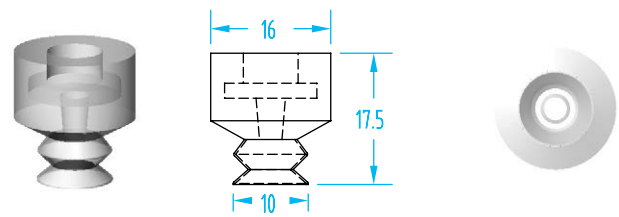

Pad øD	Part#	Quick#	Price
10mm	GSV-BSAX-10	1893	\$4.20

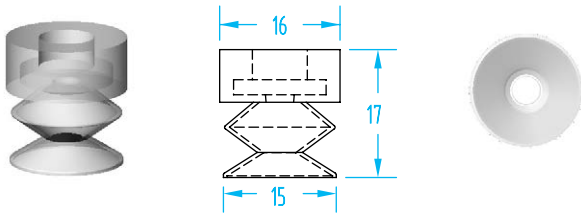

Pad øD	Part#	Quick#	Price
15mm	GSV-BSAX-15	1894	\$4.20

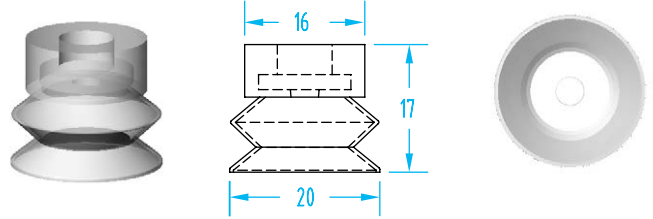

Pad øD	Part#	Quick#	Price
20mm	GSV-BSAX-20	1895	\$5.27

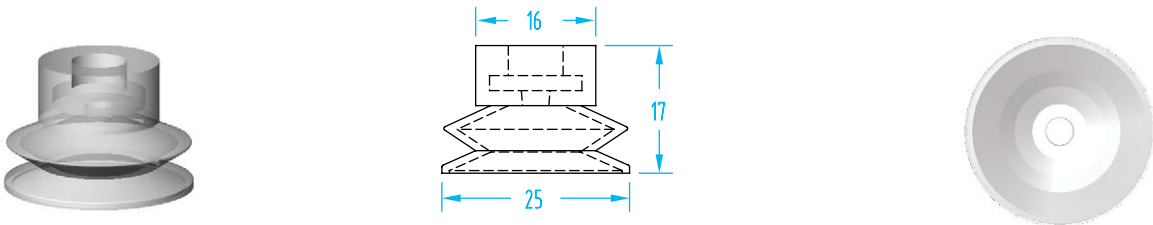

Pad øD	Part#	Quick#	Price
25mm	GSV-BSAX-25	1896	\$5.27

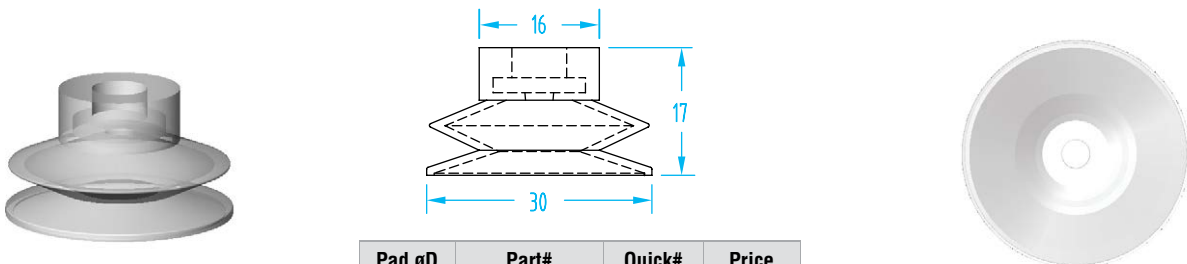

Pad øD	Part#	Quick#	Price
30mm	GSV-BSAX-30	1897	\$6.33

Vacuum Cups

Apex® - One-Nipple-Size-Fits-All

(Shown Actual Size)

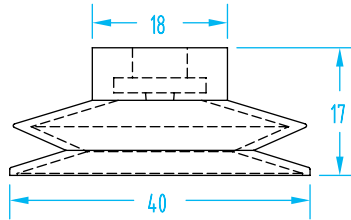
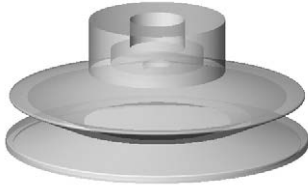

Pad øD	Part#	Quick#	Price
40mm	GSV-BSAX-40	1898	\$6.33

All vacuum cups on these two pages fit these integrated nipple suspensions.

Nipples available on page 279.

Fittings Available on page 935



'T' fitting #144 (page 942)



Suspensions

Quick#	Part#	Stroke	Weight	Price
332	GSS-65N-M10M5	10mm	41g	\$21.00
456	GSS-65N-G8M5	10mm	39g	\$21.00
1823	GSS-75L-M16N	20mm	20g	\$23.78
333	GSS-60-G8M5	20mm	19g	\$36.00

Vacuum pad #355



General purpose suspension #333

Nipple #325

Elbow fitting #120 (p.940)



Integrated nipple suspension #332

Vacuum pad #355

Plug #238 (page 958)

#456

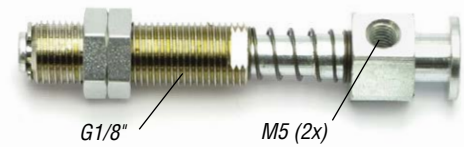

G1/8"

M5 (2x)

#332



M10x1

M5 (2x)

#1823



M5 Female

M16x1

Star® Vacuum Cups



Vacuum Cups

This family of vacuum cups offer the compatibility of integrated nipple suspensions and threaded stem nipples that fit lightweight air cylinders on page 628. Also, the molded quality is outstanding. The flat cup design allows for fast vacuum build-up and release time, resulting in faster cycles.

Star Vacuum Cup Properties

Material	Color	Max Temp.	Durometer
Silicone	Brown	482°F	50°
Fluorine	Black	446°F	65°

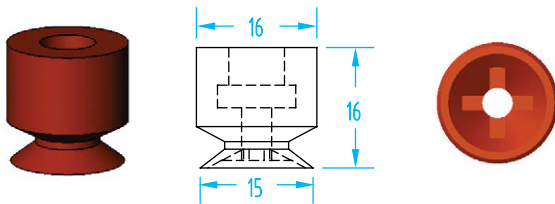

Cross Recessed (Suitable for plastic film, foil & paper)

Cup Ø	Material	Quick#	Part#	Nipple Size	Price
15mm	Silicone	1691	GSV-VAPH-15C1	Small	\$8.29

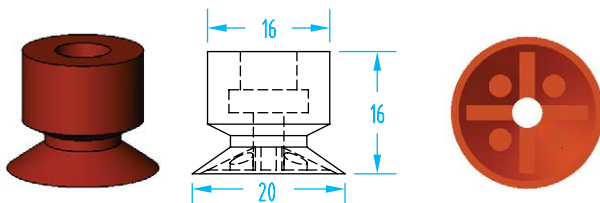

Cup Ø	Material	Quick#	Part#	Nipple Size	Price
20mm	Silicone	1692	GSV-VAPH-20C1	Small	\$9.21

Star® - Nipples and Suspensions

(Shown Actual Size)

"Mini" Suspensions

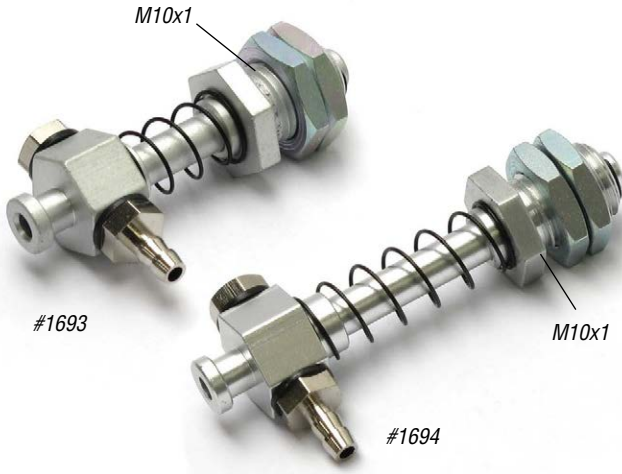

See EMIcorp.com for dimensional drawings

"Small" Suspensions



Lightweight Aluminum Suspensions

Quick#	Part#	Size	Stroke	Weight	Price
5399	GSV-VFIL-SS-5	Mini	5mm	14g	\$7.72
1693	GSV-VFIL-SS10	Mini	10mm	14g	\$12.55
1694	GSV-VFIL-SS20	Mini	20mm	16g	\$13.43
5275	GSV-VFIL-SS30	Mini	30mm	20g	\$13.69
5500	GSV-VFIL-S	Small	5mm	20g	\$7.80
1695	GSV-VFIL-S10	Small	10mm	20g	\$13.55
1696	GSV-VFIL-S20	Small	20mm	24g	\$10.26
5276	GSV-VFIL-S30	Small	30mm	30g	\$13.43

See EMIcorp.com for dimensional drawings

"Mini"

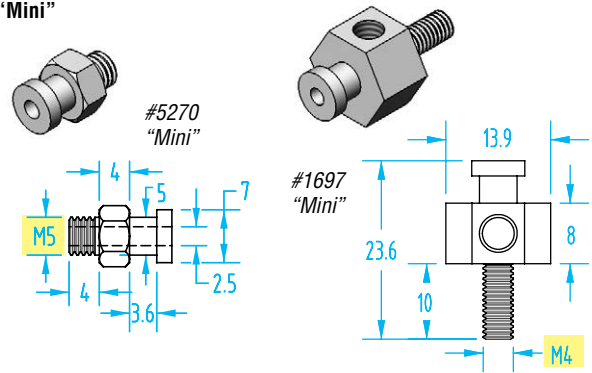

"Small"

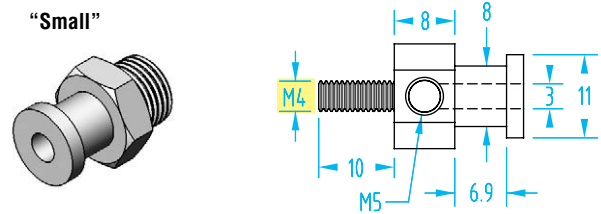

#5271 "Small"

#1698 "Small"

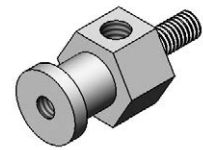
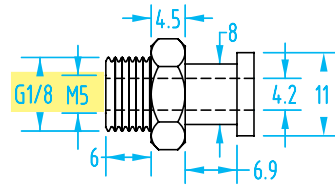

Threaded Stem Nipples

Quick#	Part#	Size	Price	Thread	Wt.
1697	GSV-CP-063	Mini	\$7.20	M4 Male	8g
5270	GSV-CP-063-M5	Mini	\$1.20	M5 Male	3g
1698	GSV-CP-064	Small	\$7.20	M4 Male	10g
5271	GSV-CP-064-G8	Small	\$5.80	G1/8"-M5	4g



#1700

#1704

Extension Mounts for Suspensions

Quick#	Part#	Size	Threaded Extension	Thread	Price
1701	GSV-CP-023AL	Mini	20mm	M10x1	\$9.21
1702	GSV-CP-024AL	Mini	40mm	M10x1	\$9.58
1699	GSV-CP-021AL	Small	20mm	M12x1	\$9.21
1700	GSV-CP-022AL	Small	40mm	M12x1	\$9.58

Lock nuts for extension mounts (order separately 2@)

1704	GSV-M10nut	Mini		M10x1	\$0.36
1703	GSV-M12nut	Small		M12x1	\$0.36

Star® - Flat

(Shown Actual Size)



Star Vacuum Cup Properties

Material	Color	Max Temp.	Durometer
Silicone	Brown	482°F	50°
Fluorine	Black	446°F	65°

Order nipples separately, see page 283.

Vacuum Cups

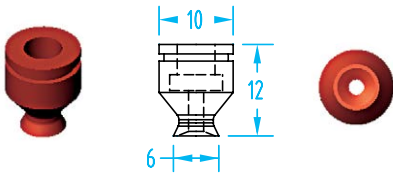

Cup Ø	Material	Quick#	Part#	Nipple Size	Price
6mm	Silicone	1674	GSV-VAPH-6C	Mini	\$3.32
	Fluorine	5228	GSV-VAPF-6C	Mini	\$16.21

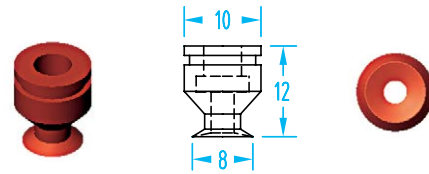

Cup Ø	Material	Quick#	Part#	Nipple Size	Price
8mm	Silicone	1675	GSV-VAPH-8C	Mini	\$3.32
	Fluorine	5229	GSV-VAPF-8C	Mini	\$16.21

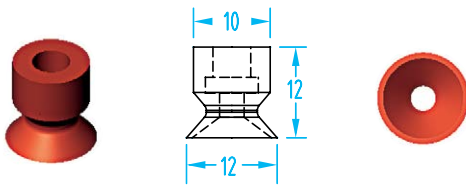

Cup Ø	Material	Quick#	Part#	Nipple Size	Price
12mm	Silicone	1677	GSV-VAPH-12C	Mini	\$3.68
	Fluorine	5230	GSV-VAPF-12C	Mini	\$18.24

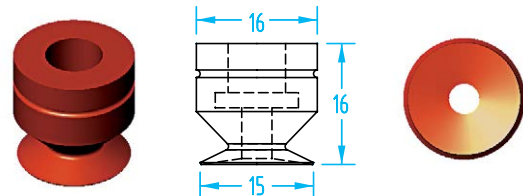

Cup Ø	Material	Quick#	Part#	Nipple Size	Price
15mm	Silicone	1984	GSV-VAPH-15C	Small	\$4.98
	Fluorine	5231	GSV-VAPF-15C	Small	\$20.27

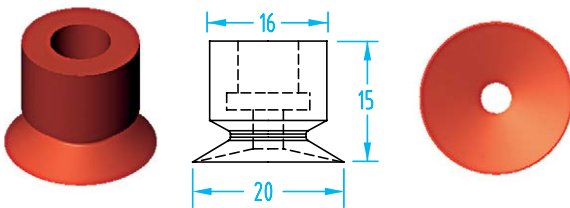

Cup Ø	Material	Quick#	Part#	Nipple Size	Price
20mm	Silicone	1679	GSV-VAPH-20C	Small	\$5.16
	Fluorine	5232	GSV-VAPF-20C	Small	\$20.27

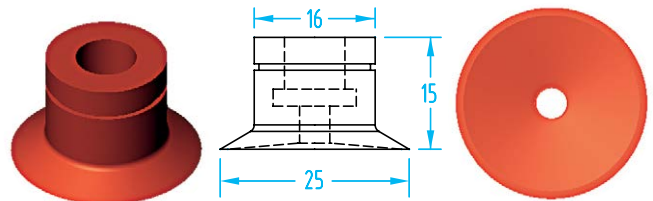

Cup Ø	Material	Quick#	Part#	Nipple Size	Price
25mm	Silicone	1680	GSV-VAPH-25C	Small	\$5.53

Star® - Flat

(Shown Actual Size)

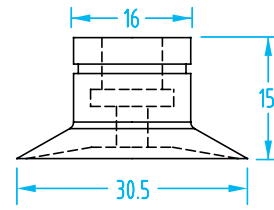
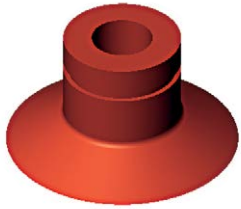

Cup Ø	Material	Quick#	Part#	Nipple Size	Price
30mm	Silicone	1681	GSV-VAPH-30C	Small	\$5.90
	Fluorine	5233	GSV-VAPF-30C	Small	\$20.27

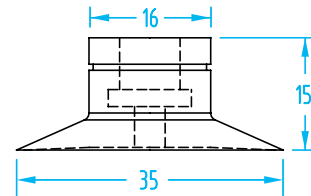
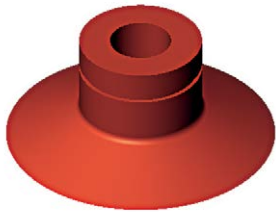

Cup Ø	Material	Quick#	Part#	Nipple Size	Price
35mm	Silicone	1682	GSV-VAPH-35C	Small	\$6.45

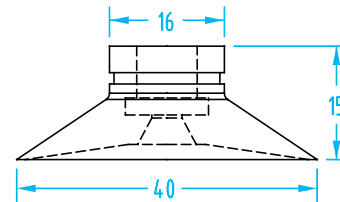
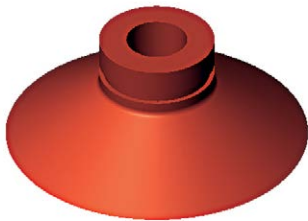

Cup Ø	Material	Quick#	Part#	Nipple Size	Price
40mm	Silicone	1683	GSV-VAPH-40C	Small	\$7.19
	Fluorine	5234	GSV-VAPF-40C	Small	\$27.64

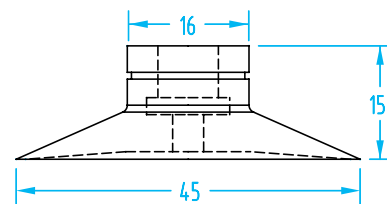
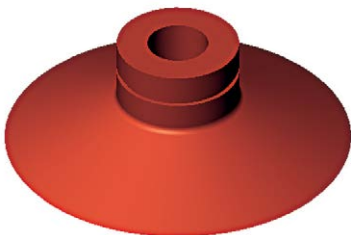

Cup Ø	Material	Quick#	Part#	Nipple Size	Price
45mm	Silicone	1684	GSV-VAPH-45C	Small	\$7.92

Star® - 2.5 Bellows

(Shown Actual Size)



Order nipples separately, see page 283.

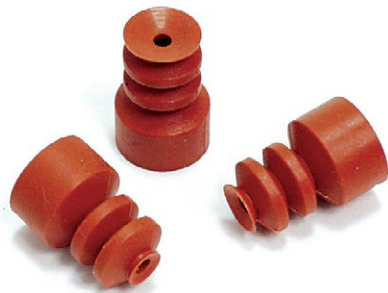

Vacuum Cups

* 13mm Compressed

Cup Ø	Material	Quick#	Part#	Nipple Size	Price
12mm	Silicone	1685	GSV-VAPH-12C2	Mini	\$7.19
	Fluorine	1687	GSV-VAPF-12C2	Mini	\$20.27

* 18mm Compressed

Cup Ø	Material	Quick#	Part#	Nipple Size	Price
20mm	Silicone	1686	GSV-VAPH-20C2	Small	\$7.74
	Fluorine	1688	GSV-VAPF-20C2	Small	\$27.64

* 13mm Compressed

Cup Ø	Material	Quick#	Part#	Nipple Size	Price
6mm	Silicone	5169	TR-1062-1	Small	\$14.01

* 13mm Compressed

Cup Ø	Material	Quick#	Part#	Nipple Size	Price
8mm	Silicone	5170	TR-1062-2	Small	\$14.01

* 13mm Compressed

Cup Ø	Material	Quick#	Part#	Nipple Size	Price
10mm	Silicone	5171	TR-1062-3	Small	\$14.01

* 13mm Compressed

Cup Ø	Material	Quick#	Part#	Nipple Size	Price
12mm	Silicone	5172	TR-1062-4	Small	\$14.01

Star® - 2.5 Bellows

(Shown Actual Size)

Star Vacuum Cup Properties

Material	Color	Max Temp.	Durometer
Silicone	Brown	482°F	50°
Fluorine	Black	446°F	65°



* 14mm Compressed

Cup Ø	Material	Quick#	Part#	Nipple Size	Price
15mm	Silicone	5158	VAPH-15C-3	Small	\$4.46

* 15mm Compressed

Cup Ø	Material	Quick#	Part#	Nipple Size	Price
20mm	Silicone	5159	VAPH-20C-3	Small	\$7.74

* 20mm Compressed

Cup Ø	Material	Quick#	Part#	Nipple Size	Price
30mm	Silicone	5160	VAPH-30C-3	Small	\$11.05

* 27mm Compressed

Cup Ø	Material	Quick#	Part#	Nipple Size	Price
40mm	Silicone	5161	VAPH-40C-3	Small	\$19.53

Foam Surface - Flat

(Shown Actual Size)

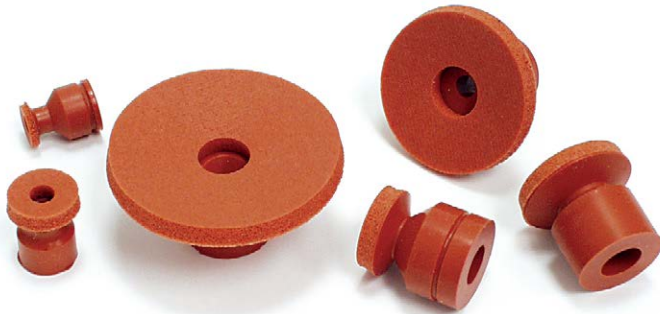

Star Foam Vacuum Cup Properties

Material	Color	Max Temp.	Durometer
Silicone	Brown	482°F	40°

Order nipples separately, see page 283.

More foam cups can be found on page 250.

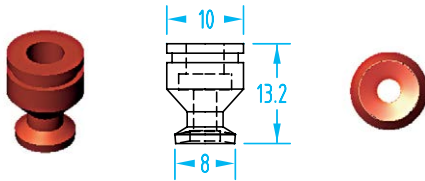

Cup Ø	Material	Quick#	Part#	Nipple Size	Price
8mm	Silicone	5162	VAPH-8C-SP	Mini	\$11.97

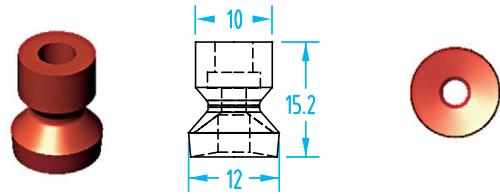

Cup Ø	Material	Quick#	Part#	Nipple Size	Price
12mm	Silicone	5163	VAPH-12C-SP	Mini	\$13.81

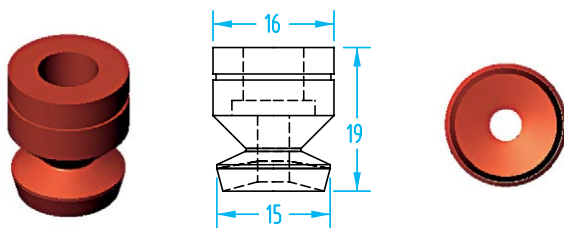

Cup Ø	Material	Quick#	Part#	Nipple Size	Price
15mm	Silicone	5164	VAPH-15C-SP	Small	\$11.97

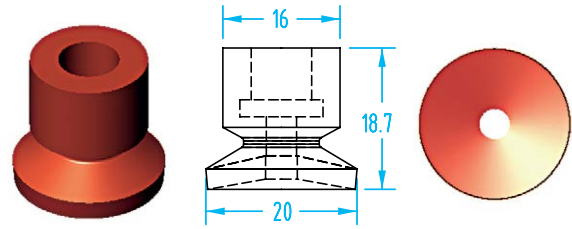

Cup Ø	Material	Quick#	Part#	Nipple Size	Price
20mm	Silicone	5165	VAPH-20C-SP	Small	\$12.71



Cup Ø	Material	Quick#	Part#	Nipple Size	Price
30mm	Silicone	5166	VAPH-30C-SP	Small	\$17.51

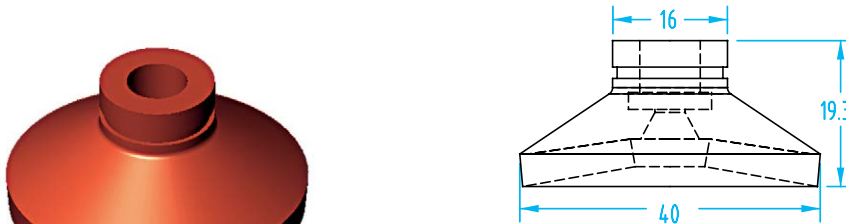

Cup Ø	Material	Quick#	Part#	Nipple Size	Price
40mm	Silicone	5167	VAPH-40C-SP	Small	\$22.11
60mm*	Silicone	5168	VAPH-60C-SP	5883	\$27.64

*#5168 & #5883 not shown, call EMI or visit website for details.

Foam Surface - 1.5 Bellows

(Shown Actual Size)

All vacuum cups on this page use the same nipple size!
See page 279 for nipples and suspensions.



* 13mm Compressed

Cup Ø	Material	Quick#	Part#	Price
20mm	Foam Surface	5203	GSV-BSF-20	\$19.27

* 14mm Compressed

Cup Ø	Material	Quick#	Part#	Price
25mm	Silicone	5204	GSV-BSF-25	\$19.94

Foam Vacuum Cup Properties

Material	Color	Max Temp.	Durometer
Silicone	Translucent	320°F	30°

Cup Ø	Material	Quick#	Part#	Price
25mm	Silicone	5204	GSV-BSF-25	\$19.94

* 15mm Compressed

Cup Ø	Material	Quick#	Part#	Price
30mm	Silicone	5205	GSV-BSF-30	\$20.60

* 17mm Compressed

Cup Ø	Material	Quick#	Part#	Price
40mm	Silicone	5206	GSV-BSF-40	\$21.49

Vacuum Cups

Silicone - Oval

(Shown Actual Size)



Oval Vacuum Cup Properties

Material	Color	Max Temp.	Durometer
Silicone	semi-translucent clear	392°F	50°

See page 210 for Hithane™ Oval Vacuum Cups.

New, improved design!

Note: All of these cups can be used in contact with isopropyl alcohol.

Vacuum Cups

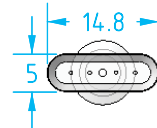
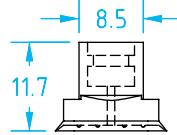
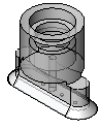

Quick#	Part#	Pad øD	Price
376	GSV-OS-5x15	5x15mm	\$17.20
Nipple			
378	GSF-N21-M5M	Male M5	\$5.50
379	GSF-N21-M5F	Female M5	\$5.50

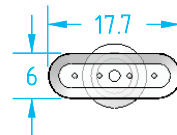
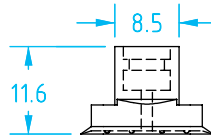
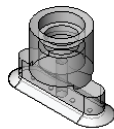

Quick#	Part#	Pad øD	Price
377	GSV-OS-6x18	6x18mm	\$19.05
Nipple			
378	GSF-N21-M5M	Male M5	\$5.50
379	GSF-N21-M5F	Female M5	\$5.50

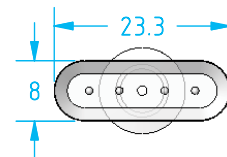
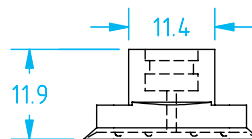
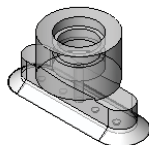

Quick#	Part#	Pad øD	Price
380	GSV-OS-8x24	8x24mm	\$20.40
Nipple			
382	GSF-N22-G8M	G1/8"	\$9.61
383	GSF-N22-G8F	G1/8"	\$6.00

Silicone - Oval

(Shown Actual Size)

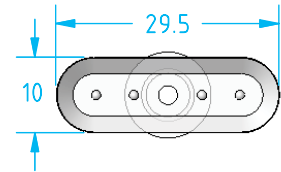
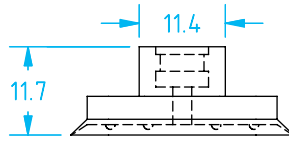
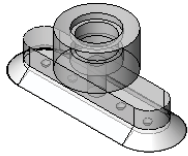

Quick#	Part#	Pad øD	Price
381	GSV-OS-10x30	10x30mm	\$23.00
Nipple			
382	GSF-N22-G8M	Male G1/8"	\$9.61
383	GSF-N22-G8F	Female G1/8"	\$6.00

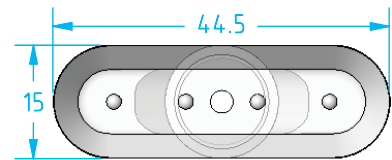
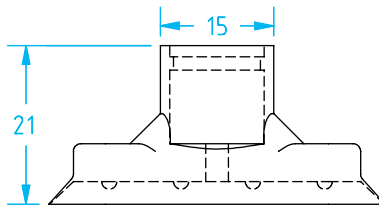
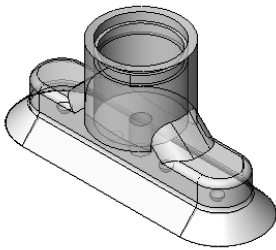

Quick#	Part#	Pad øD	Price
384	GSV-OS-15x45	15x45mm	\$23.65
Nipple			
655	GSF-NF0-G4F	Female G1/4"	\$4.55

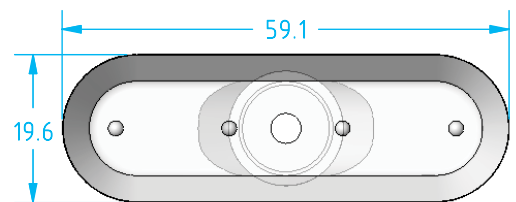
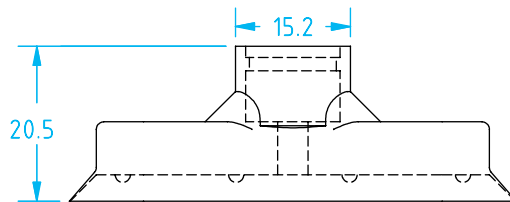
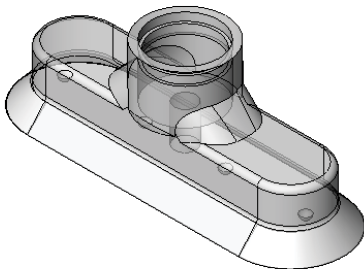

Quick#	Part#	Pad øD	Price
385	GSV-OS-20x60	20x60mm	\$28.85
Nipple			
655	GSF-NF0-G4F	Female G1/4"	\$4.55

Silicone - Oval 2.5 Bellows



Oval bellows cups can be used on medium contour surfaces without using special angle adjusting mounting brackets.

The 2.5 bellows provide extra compression that can sometimes be used in place of expensive non-rotating suspensions.

Oval Bellows Vacuum Cup Properties

Material	Color	Max Temp.	Durometer
Silicone	Semi-translucent clear	392°F	55°

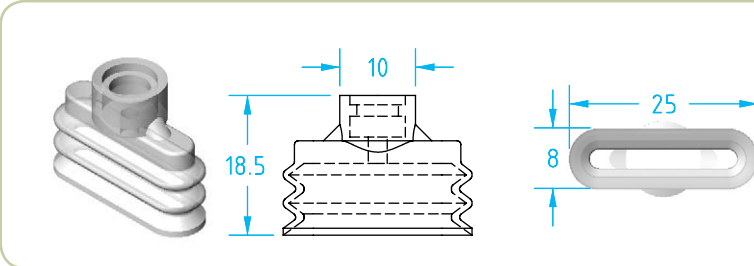

Quick#	Part#	Pad øD	Price
1293	GSV-OBS-8x25	8x25mm	\$16.95
Nipple			
649	GSF-NF8-M5M	Male M5	\$4.08
651	GSF-NF9-G8M	Male G1/8"	\$4.75
652	GSF-NF9-G8F	Female G1/8"	\$4.92

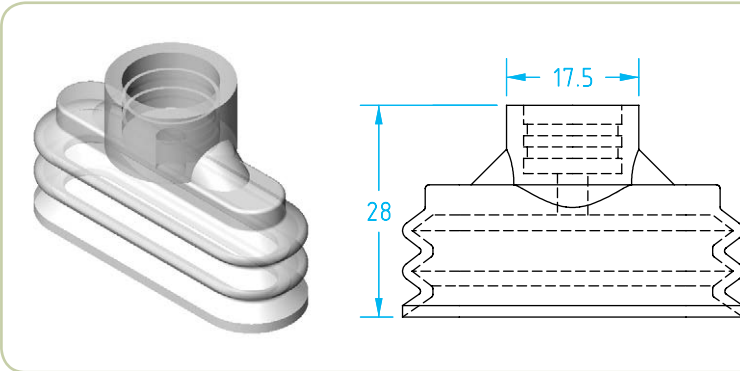

Quick#	Part#	Pad øD	Price
1294	GSV-OBS-15x45	15x45mm	\$20.85
Nipple			
655	GSF-NF0-G4F	Female G1/4"	\$4.55

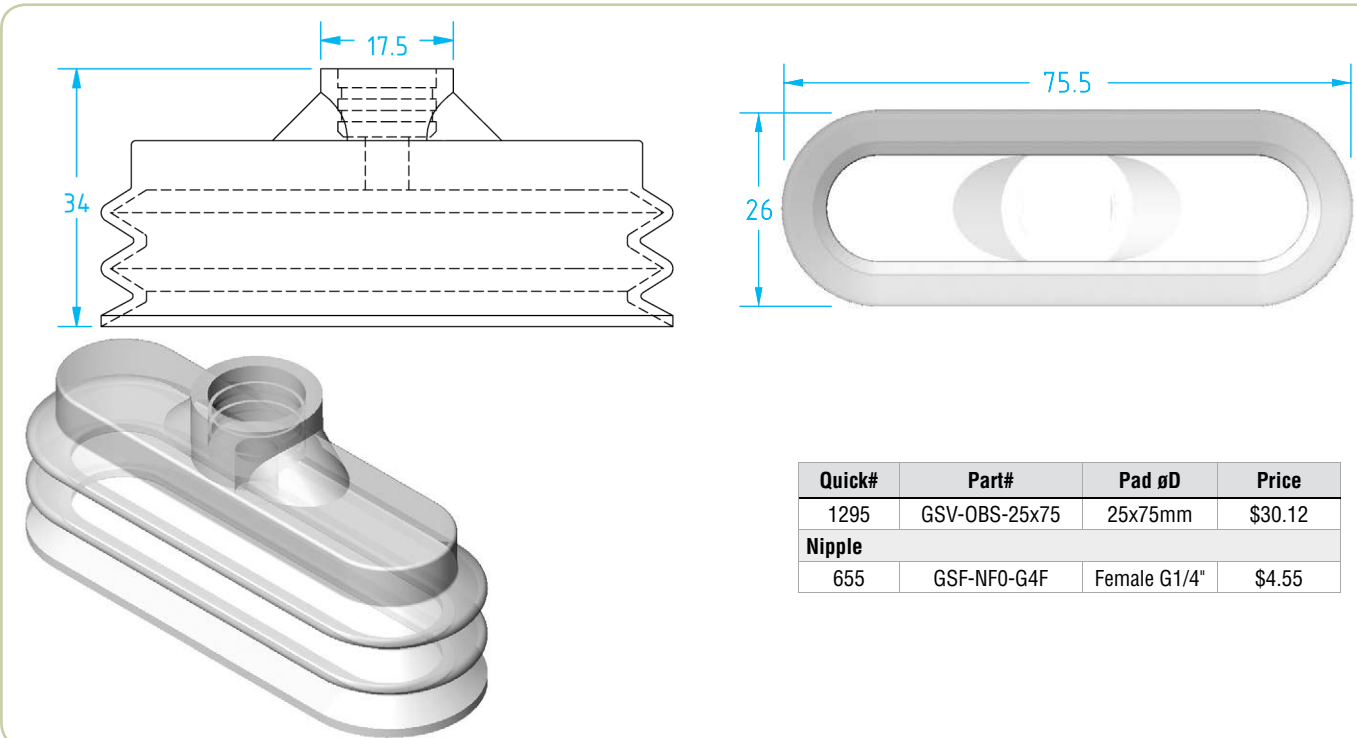

Quick#	Part#	Pad øD	Price
1295	GSV-OBS-25x75	25x75mm	\$30.12
Nipple			
655	GSF-NF0-G4F	Female G1/4"	\$4.55

Super -Sucker Vacuum Cups

(Shown Actual Size)

Try this super flexible vacuum cup on parts that are difficult to maintain good vacuum on, such as textured, or easily distortable parts like foils.



Super-Sucker Vacuum Cup Properties

Material	Color	Max Temp.	Durometer
Silicone	Semi-translucent white	392°F	30°
Natural Rubber	Blue	176°F	30°

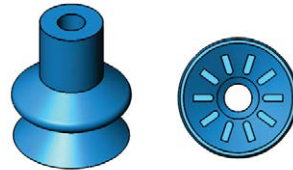
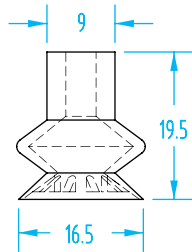

#1662

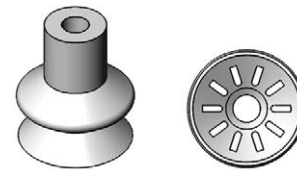

#1663

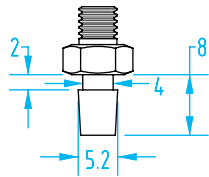

#411

Super-Sucker Cups

Material	Quick#	Part#	Price
Silicone	1663	GSV-SVC-18SI	\$5.74
Natural Rubber	1662	GSV-SVC-18NR	\$5.74
Nipples - Order Separately			
Male M5	411	GSF-NF1-M5	\$1.67

Mini Flat Vacuum Cup - Ø1mm – Ø6mm

(Shown Actual Size)

1mm

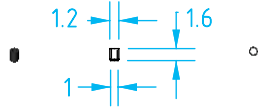

Quick#	Part#	Material	Price
5452	VN1-1-N	Nitrile	\$7.80
5453	VN1-1-S	Silicone	\$8.30
Nipples - Order Separately			
5463	GSF-MN1-M3	Male M3	\$5.32

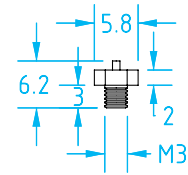

1.5mm

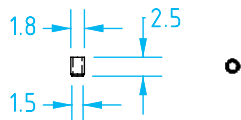

Quick#	Part#	Material	Price
5454	VN1-1.5-N	Nitrile	\$7.80
5455	VN1-1.5-S	Silicone	\$8.33
Nipples - Order Separately			
5464	GSF-MN15-M3	Male M3	\$5.32

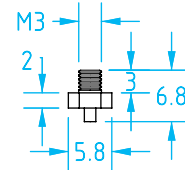

2mm

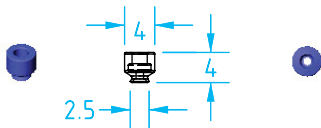

Quick#	Part#	Material	Price
3187	VN1-2-S	Silicone	\$3.18
3186	VN1-2-N	Nitrile	\$2.50
3188	VN1-2-P	Polyurethane	\$8.10
1241	GSV-MFA-2	Anti-Static Silicone	\$6.00
Nipples - Order Separately			
3286	VSA10	Male M5	\$2.80
1267	GSF-N17-M3M	Male M3	\$3.67

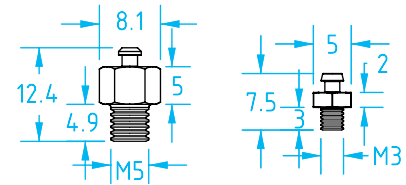

2mm

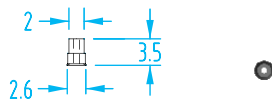

Quick#	Part#	Material	Price
5091	GSV-U2-25	Anti-Static Silicone	\$7.91
Nipples - Order Separately			
5464	GSF-MN15-M3	Male M3	\$5.32

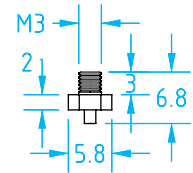

2mm

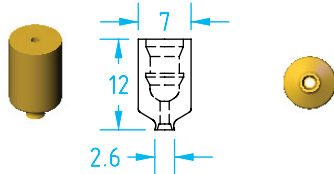

Quick#	Part#	Material	Price
2501	ZP02US	Silicone	\$2.45
2535	ZP02UU	Polyurethane	\$2.95
2604	ZP02UN	Nitrile	\$2.25
2683	ZP02UGS	Anti-static	\$2.40
Nipples - Order Separately			
258	GSF-BS-M506	Male M5	\$0.78
1070	ZPT1B5	Female M5	\$3.10

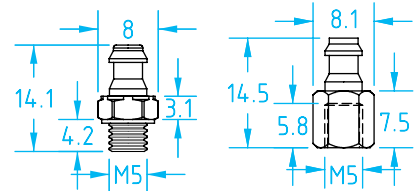

3mm

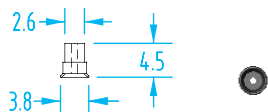

Quick#	Part#	Material	Price
5092	GSV-U3-25	Anti-Static Silicone	\$8.47
Nipples - Order Separately			
5464	GSF-MN15-M3	Male M3	\$5.32

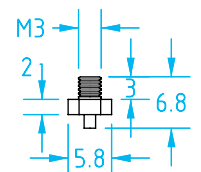

Mini Flat Vacuum Cup - Ø1mm - Ø5mm

(Shown Actual Size)

3.5mm

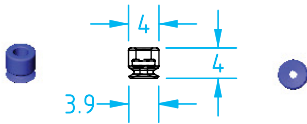

Quick#	Part#	Material	Price
3189	VN1-3.5-N	Nitrile	\$2.58
3190	VN1-3.5-S	Silicone	\$3.18
3191	VN1-3.5-P	Polyurethane	\$8.10
5457	VN1-3.5-V	Viton	\$29.40
1244	GSV-MFA-35	Anti-Static Silicone	\$5.80
Nipples - Order Separately			
3286	VSA10	Male M5	\$2.80
1267	GSF-N17-M3M	Male M3	\$3.67

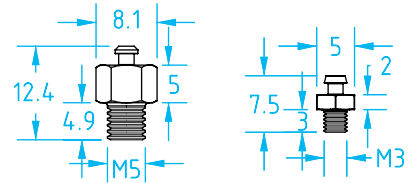

4mm

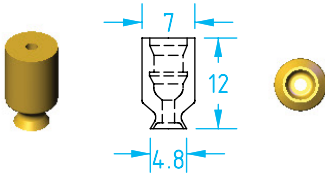

Quick#	Part#	Material	Price
2502	ZP04US	Silicone	\$2.45
2536	ZP04UU	Polyurethane	\$2.95
2605	ZP04UN	Nitrile	\$2.25
2684	ZP04UGS	Anti-static	\$2.40
Nipples - Order Separately			
258	GSF-BS-M506	Male M5	\$0.78
1070	ZPT1B5	Female M5	\$3.10

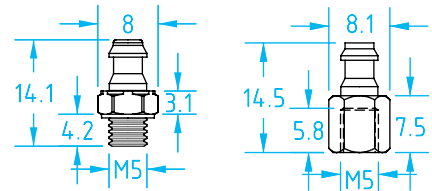

5mm

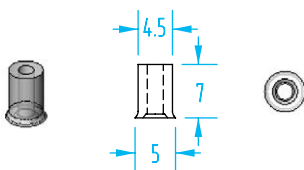

Quick#	Part#	Material	Price
673	GSV-FOS-5	Silicone	\$2.10
1113	GSV-FOH-5	Hithane	\$4.91
1153	GSV-FON-5	Nitrile	\$1.85
Nipples - Order Separately			
688	GSF-NF11-M5	M5 Male	\$2.20

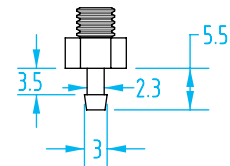

5mm

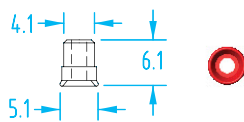

Quick#	Part#	Material	Price
5093	GSV-U4-20	Silicone	\$5.82
5102	GSV-U4-10	Chloroprene	\$2.49
Nipples - Order Separately			
1438	GSV-01AB	Male M5	\$1.76

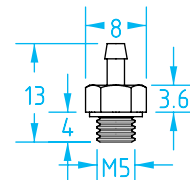

5mm

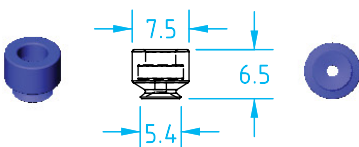

Quick#	Part#	Material	Price
3192	VN1-5-N	NIT	\$2.16
3193	VN1-5-S	Silicone	\$2.72
3194	VN1-5-P	Polyurethane	\$4.00
1247	GSV-MFA-5	Anti-static Silicone	\$5.91
Nipples - Order Separately			
3289	VSA30	Male M5	\$2.80
5178	VSA30F	Female M5	\$2.80

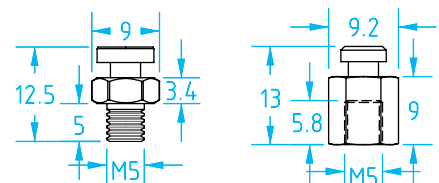

Mini Flat Vacuum Cup - Ø6mm – Ø9mm

(Shown Actual Size)

6mm

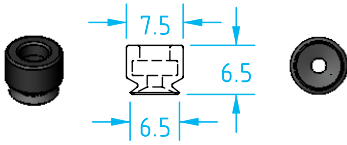

Quick#	Part#	Material	Price
1249	GSV-MFS-6	Silicone	\$3.60
1250	GSV-MFA-6	Anti-static Silicone	\$4.60
5459	VN1-6-N	Nitrile	\$2.80
Nipples - Order Separately			
3289	VSA30	Male M5	\$2.80
5178	VSA30F	Female M5	\$2.80

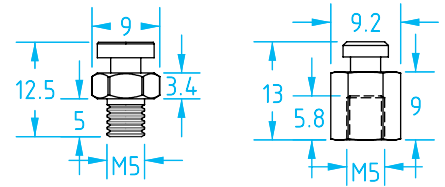

6mm

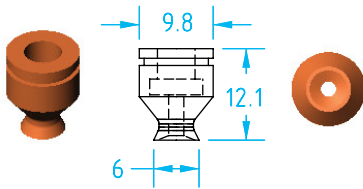

Quick#	Part#	Material	Price
1674	GSV-VAPH-6C	Silicone	\$3.32
5221	GSV-VAPU-6C	Polyurethane	\$9.39
5228	GSV-VAPF-6C	Fluorine	\$16.22
Nipples - Order Separately			
5270	GSV-CP-063-M5	Male M5	\$1.20
1697	GSV-CP-063	Male M4	\$20.27

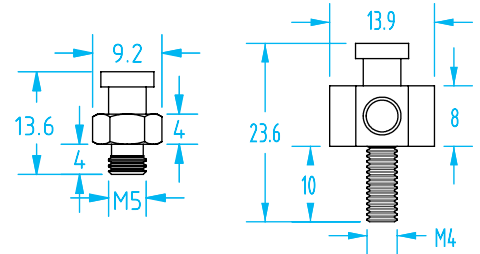

6mm

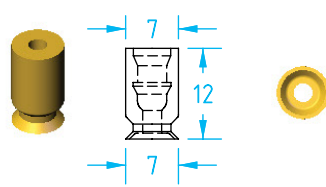

Quick#	Part#	Material	Price
2503	ZP06US	Silicone	\$2.45
2537	ZP06UU	Polyurethane	\$2.95
2606	ZP06UN	Nitrile	\$2.25
Nipples - Order Separately			
258	GSF-BS-M506	Male M5	\$0.78
1070	ZPT1B5	Female M5	\$3.10

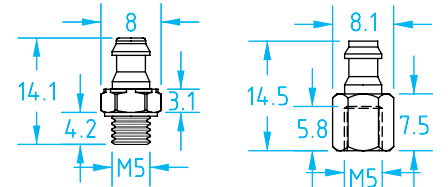

7mm

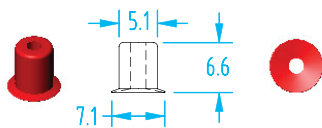

Quick#	Part#	Material	Price
5094	GSV-U6-20	Silicone	\$4.45
5103	GSV-U6-10	Chloroprene	\$2.18
Nipples - Order Separately			
1438	GSV-01AB	Male M5	\$1.76

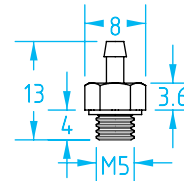

7mm

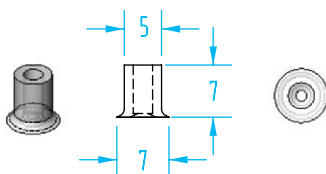

Quick#	Part#	Material	Price
674	GSV-FOS-7	Silicone	\$2.39
1114	GSV-FOH-7	Hithane	\$4.91
1154	GSV-FON-7	Nitrile	\$1.85
Nipples - Order Separately			
688	GSF-NF11-M5	M5 Male	\$2.20

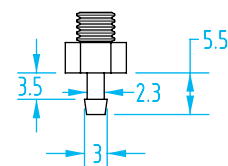

Mini Flat Vacuum Cup - Ø6mm - Ø9mm

(Shown Actual Size)

8mm

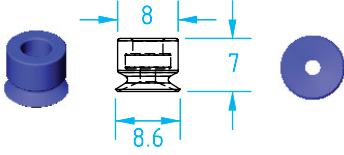

Quick#	Part#	Material	Price
3195	VN1-8-N	Nitrile	\$2.33
3196	VN1-8-S	Silicone	\$2.72
3197	VN1-8-P	Polyurethane	\$4.00
1253	GSV-MFA-8	Anti-static Silicone	\$4.60
Nipples - Order Separately			
3289	VSA30	Male M5	\$2.80
5178	VSA30F	Female M5	\$2.80

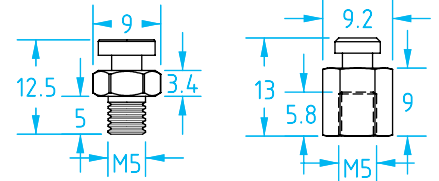

8mm

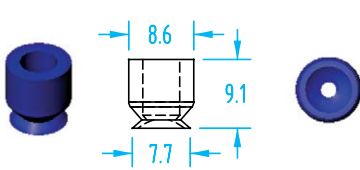

Quick#	Part#	Material	Price
1645	GSV-FHT-8	Hithane	\$5.01
Nipples - Order Separately			
5431	GSF-HTN1-M5F	Female M5	\$3.59
408	GSF-N16-M5M	Male M5	\$3.35

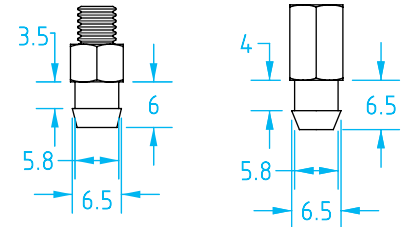

8mm

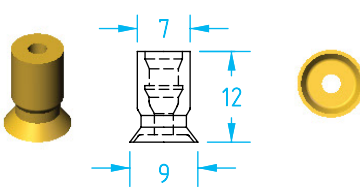

Quick#	Part#	Material	Price
2504	ZP08US	Silicone	\$2.45
2538	ZP08UU	Polyurethane	\$2.95
2607	ZP08UN	Nitrile	\$2.25
2685	ZP08UGS	Anti-static	\$2.40
Nipples - Order Separately			
258	GSF-BS-M506	Male M5	\$0.78
1070	ZPT1B5	Female M5	\$3.10

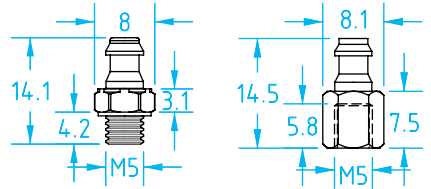

8mm

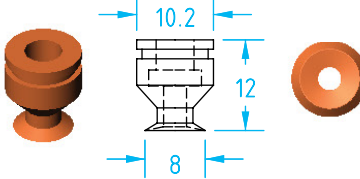

Quick#	Part#	Material	Price
1675	GSV-VAPH-8C	Silicone	\$3.32
5222	GSV-VAPU-8C	Polyurethane	\$9.39
5229	GSV-VAPF-8C	Fluorine	\$16.22
5162	VAPH-8C-SP	Silicone-Foam	\$11.97
Nipples - Order Separately			
5270	GSV-CP-063-M5	Male M5	\$1.20
1697	GSV-CP-063	Male M4	\$20.27

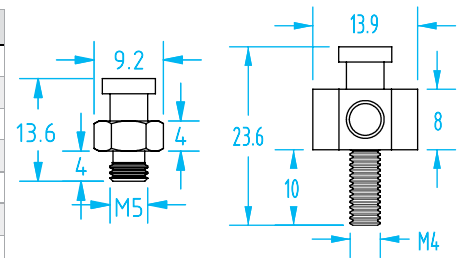

9mm

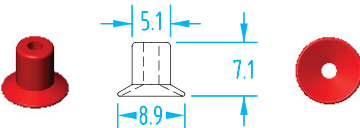

Quick#	Part#	Material	Price
5095	GSV-U8-20	Silicone	\$4.81
5104	GSV-U8-10	Chloroprene	\$2.18
Nipples - Order Separately			
1438	GSV-01AB	Male M5	\$1.76

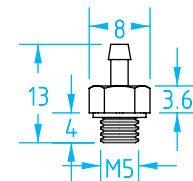

1.5 Bellows Mini Vacuum Cup - Ø4.5mm – Ø10.5mm

(Shown Actual Size)

4.5mm

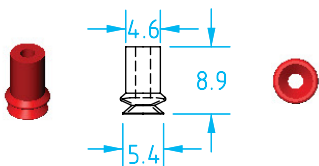

Quick#	Part#	Material	Price
1413	GSV-B5-20	Silicone	\$6.59
5115	GSV-B5-10	Chloroprene	\$2.35
Nipples - Order Separately			
1438	GSV-O1AB	Male M5	\$1.76

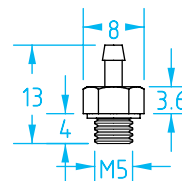

5mm

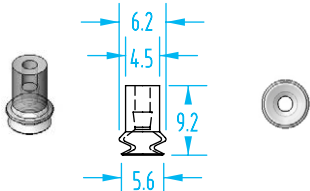

Quick#	Part#	Material	Price
1142	GSV-BOS-5	Silicone	\$3.66
1133	GSV-BOH-5	Hithane	\$6.69
1144	GSV-BON-5	Nitrile	\$2.03
Nipples - Order Separately			
688	GSF-NF11-M5	M5 Male	\$2.20

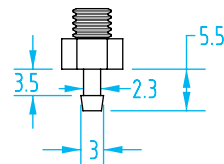

5mm

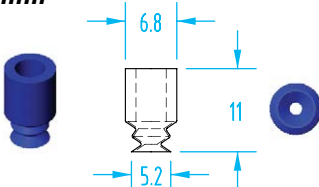

Quick#	Part#	Material	Price
5988	GSV-BHT-5	Hithane	\$10.93
Nipples - Order Separately			
258	GSF-BS-M506	Male M5	\$0.78
1070	ZPT1B5	Female M5	\$3.10

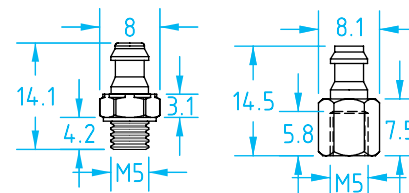

5.5mm

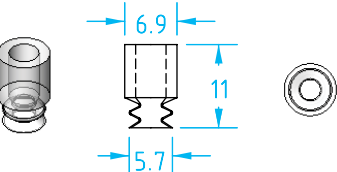

Quick#	Part#	Material	Price
5487	GSV-MBS-45S	Silicone	\$4.85
Nipples - Order Separately			
258	GSF-BS-M506	Male M5	\$0.78
1070	ZPT1B5	Female M5	\$3.10

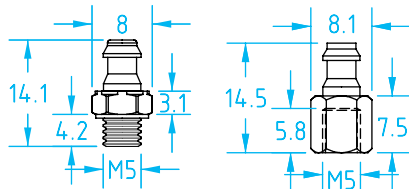

6mm

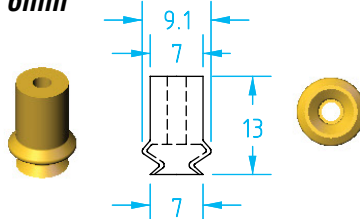

Quick#	Part#	Material	Price
2525	ZP06BS	Silicone	\$4.25
2559	ZP06BU	Polyurethane	\$4.60
2625	ZP06BN	Nitrile	\$4.05
2678	ZP06BGS	Anti-static	\$4.20
Nipples - Order Separately			
258	GSF-BS-M506	Male M5	\$0.78
1070	ZPT1B5	Female M5	\$3.10

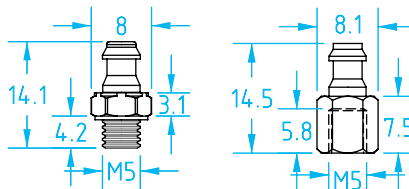

6.5mm

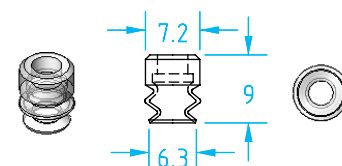

Quick#	Part#	Material	Price
5488	GSV-MBS-65S	Silicone	\$3.20
Nipples - Order Separately			
3289	VSA30	Male M5	\$2.80
5178	VSA30F	Female M5	\$2.80

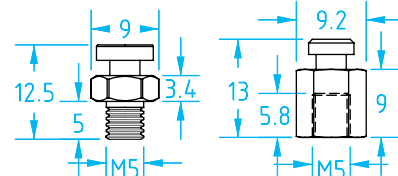

1.5 Bellows Mini Vacuum Cup - Ø4.5mm – Ø10.5mm

(Shown Actual Size)

7.5mm

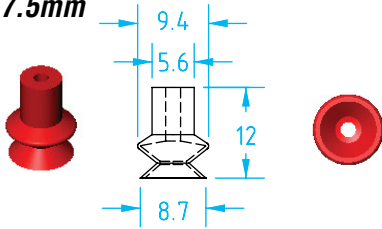

Quick#	Part#	Material	Price
1414	GSV-B8-20	Silicone	\$7.70
5116	GSV-B8-10	Chloroprene	\$2.90
Nipples - Order Separately			
1438	GSV-01AB	Male M5	\$1.76

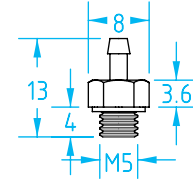

8mm

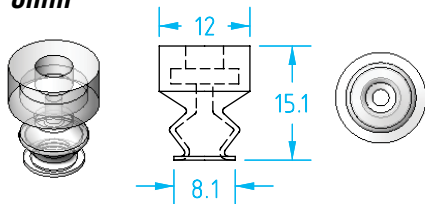

Quick#	Part#	Material	Price
5489	GSV-MBS-8S	Silicone	\$5.96
Nipples - Order Separately			
1599	GSF-HSN-M5	Male M5	\$5.20

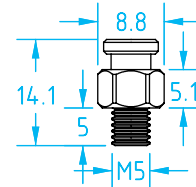

8mm

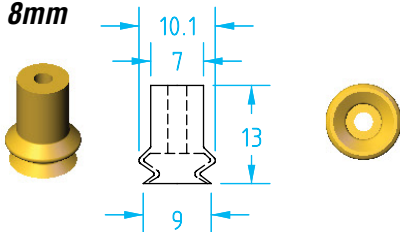

Quick#	Part#	Material	Price
2526	ZP08BS	Silicone	\$4.25
2560	ZP08BU	Polyurethane	\$4.60
2624	ZP08BN	Nitrile	\$4.05
2679	ZP08BGS	Anti-static	\$4.20
Nipples - Order Separately			
258	GSF-BS-M506	Male M5	\$0.78
1070	ZPT1B5	Female M5	\$3.10

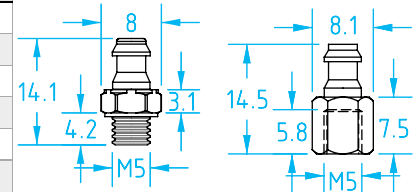

8.5mm

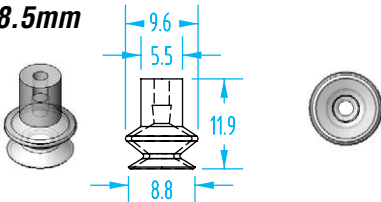

Quick#	Part#	Material	Price
1143	GSV-BOS-8	Silicone	\$4.12
1134	GSV-BOH-8	Hithane	\$6.35
1145	GSV-BON-8	Nitrile	\$2.21
Nipples - Order Separately			
688	GSF-NF11-M5	M5 Male	\$2.20

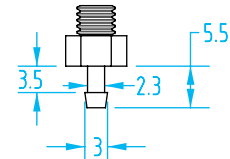

9.5mm

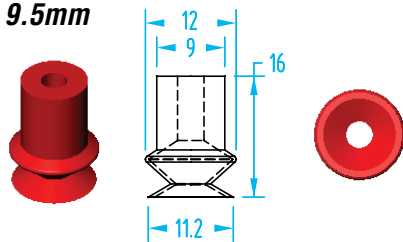

Quick#	Part#	Material	Price
1415	GSV-B10-2-20	Silicone	\$6.77
5117	GSV-B10-2-10	Chloroprene	\$3.60
Nipples - Order Separately			
1439	GSV-01AC	Male M5	\$1.76

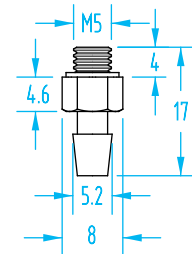

10.5mm

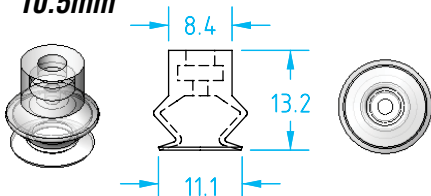

Quick#	Part#	Material	Price
5490	GSV-MBS-10S	Silicone	\$3.50
Nipples - Order Separately			
3289	VSA30	Male M5	\$2.80
5178	VSA30F	Female M5	\$2.80

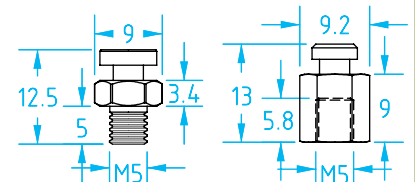

2.5 Bellows Mini Vacuum Cup - Ø4.5mm – Ø9mm

(Shown Actual Size)

4.5mm

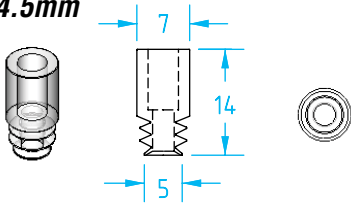

Quick#	Part#	Material	Price
1258	GSV-M2BS-4	Silicone	\$3.42
Nipples - Order Separately			
1439	GSV-01AC	Male M5	\$1.76
1070	ZPT1B5	Female M5	\$3.10

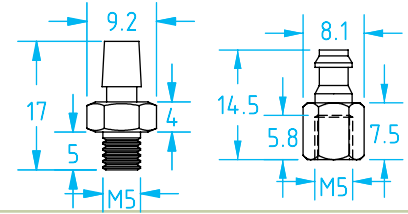

4.5mm

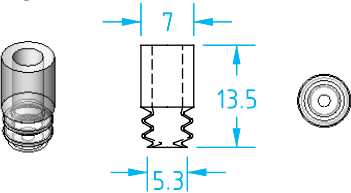

Quick#	Part#	Material	Price
5491	GSV-M2BS-5S	Silicone	\$3.28
Nipples - Order Separately			
258	GSF-BS-M506	Male M5	\$0.78
1070	ZPT1B5	Female M5	\$3.10

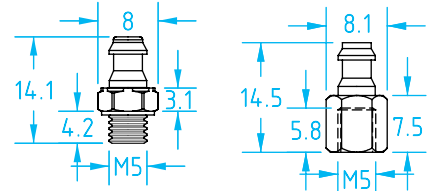

5mm

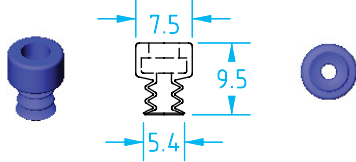

Quick#	Part#	Material	Price
3256	VN3-5-N	Nitrile	\$4.18
3257	VN3-5-S	Silicone	\$4.98
3258	VN3-5-P	Polyurethane	\$8.04
Nipples - Order Separately			
3289	VSA30	Male M5	\$2.80
5178	VSA30F	Female M5	\$2.80

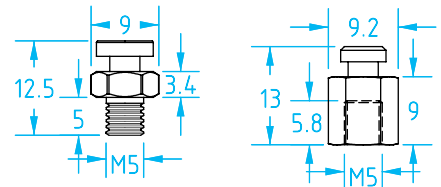

6mm

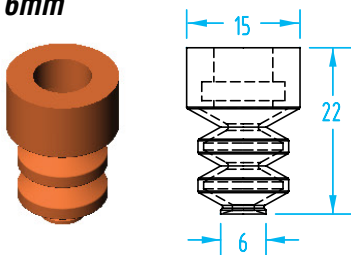

Quick#	Part#	Material	Price
5169	TR-1062-1	Silicone	\$14.00
Nipples - Order Separately			
1698	GSV-CP-064	Male M4	\$19.17
5271	GSV-CP-064-G8	G1/8"-M5	\$5.80

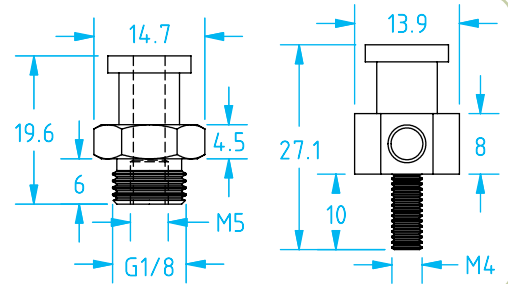

6mm

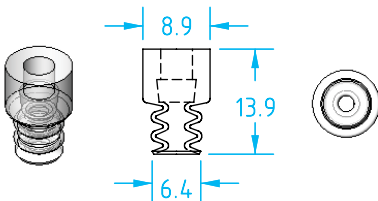

Quick#	Part#	Material	Price
5492	GSV-M2BS-65S	Silicone	\$3.20
Nipples - Order Separately			
258	GSF-BS-M506	Male M5	\$0.78
1070	ZPT1B5	Female M5	\$3.10

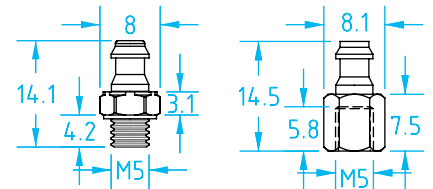

7mm

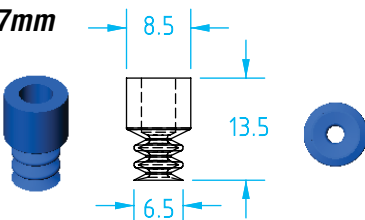

Quick#	Part#	Material	Price
5442	GSV-2BHT-7	Hithane	\$8.60
Nipples - Order Separately			
408	GSF-N16-M5M	Male M5	\$3.35
5431	GSF-HTN1-M5F	Female M5	\$3.59

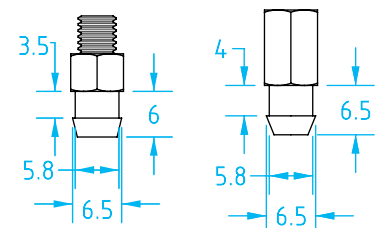

2.5 Bellows Mini Vacuum Cup - Ø4.5mm – Ø9mm

(Shown Actual Size)

7mm

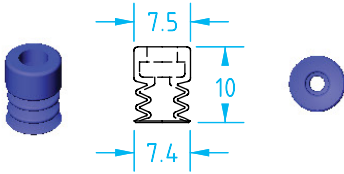

Quick#	Part#	Material	Price
3259	VN3-8-N	Nitrile	\$4.18
3260	VN3-8-S	Silicone	\$4.98
3261	VN3-8-P	Polyurethane	\$8.04
Nipples - Order Separately			
3289	VSA30	Male M5	\$2.80
5178	VSA30F	Female M5	\$2.80

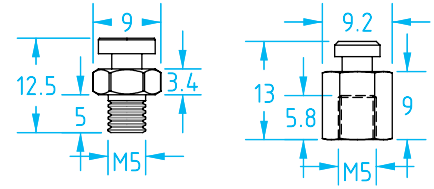

8mm

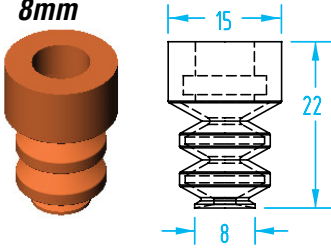

Quick#	Part#	Material	Price
5170	TR-1062-2	Silicone	\$14.00
Nipples - Order Separately			
1698	GSV-CP-064	Male M4	\$19.17
5271	GSV-CP-064-G8	G1/8"-M5	\$5.80

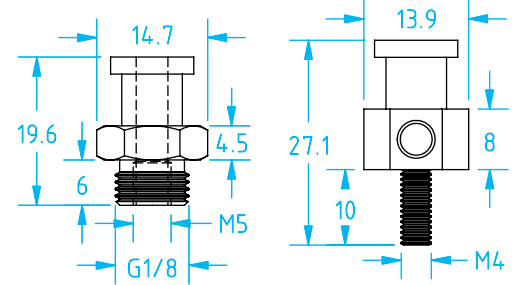

9mm

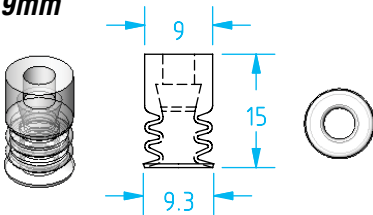

Quick#	Part#	Material	Price
5493	GSV-M2BS-9S	Silicone	\$3.50
Nipples - Order Separately			
258	GSF-BS-M506	Male M5	\$0.78
1070	ZPT1B5	Female M5	\$3.10

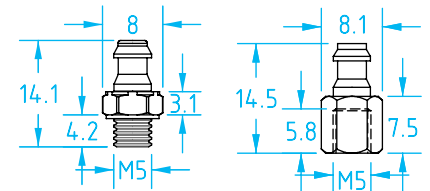

9mm

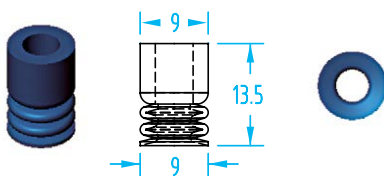

Quick#	Part#	Material	Price
1657	GSV-2BHT-9	Hithane	\$6.83
Nipples - Order Separately			
408	GSF-N16-M5M	Male M5	\$3.35
5431	GSF-HTN1-M5F	Female M5	\$3.59

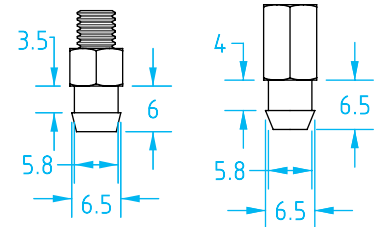

Cups for Carbon Fiber Parts and Sheet

(Shown Actual Size)



No needle damage!

Handle hot molded carbon fiber parts and cold carbon fiber sheet without damage caused when using needle grippers.

Vacuum Cups

1. PTFE vacuum cup does not stick to hot carbon fiber parts up to 480°F.
2. Flexible silicone bellow allows axial and angular movements for part compliance.
3. Stainless steel nipple included.
4. The supporting ribs avoid suction and deformation of soft materials.
5. The flexible lip allows good vacuum even at the low temperatures for effective sealing over cold composites.
6. Patented

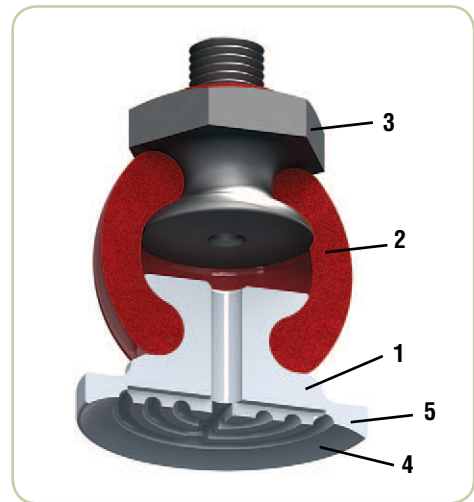

Quick#	Part#	Cup Ø	Weight	Price
7339	PAAT16R	16mm	9g	\$69.50

Quick#	Part#	Cup Ø	Weight	Price
7340	PAAT20R	20mm	9g	\$69.50

Cups for Carbon Fiber Parts and Sheet

(Shown Actual Size)

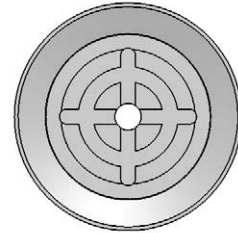
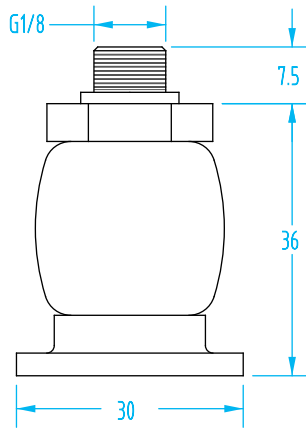
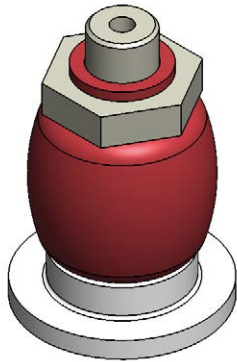

Quick#	Part#	Cup Ø	Weight	Price
7341	PAAT30R	30mm	35g	\$79.00

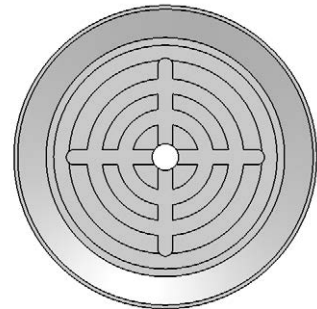
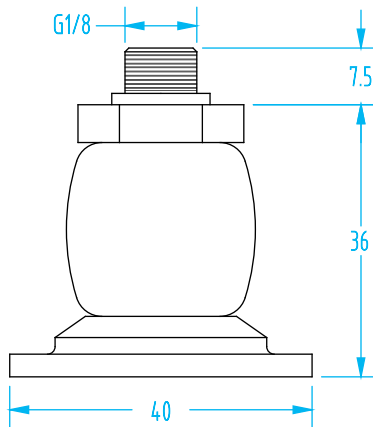
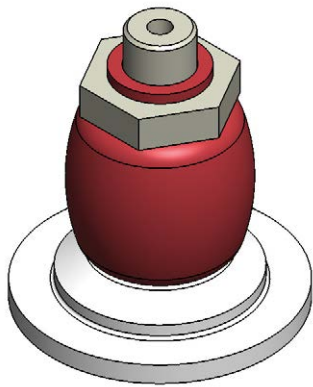

Quick#	Part#	Cup Ø	Weight	Price
7342	PAAT40R	40mm	37g	\$87.25

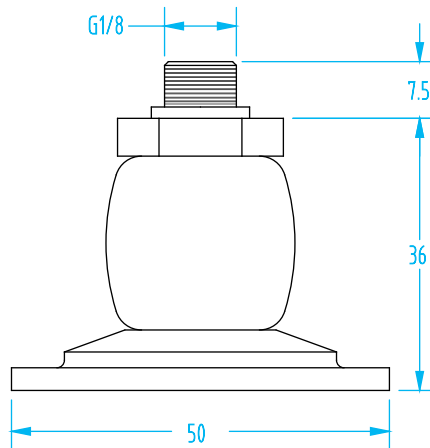
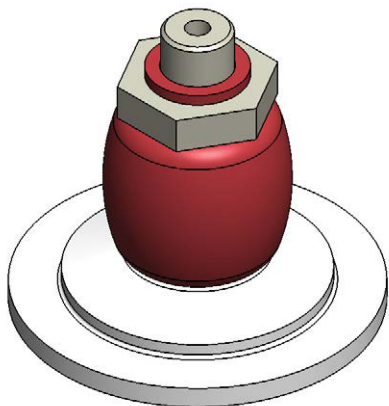

Quick#	Part#	Cup Ø	Weight	Price
7343	PAAT50R	50mm	41g	\$97.00

High Speed Specialty - Flat

(Shown Actual Size)



These cups are optimized in their design for use in high-speed applications such as thin-wall molding of parts having flat surfaces. Their design allows faster attach/release time than other flat cups.

High Speed Vacuum Cup Properties

Material	Color	Max Temp.	Durometer
Silicone	Semi-translucent white	392°F	40°
Polyurethane	Blue	176°F	40°

Vacuum Cups

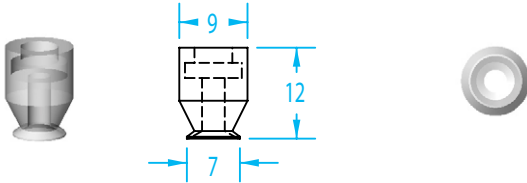

Pad øD	Part#	Material	Quick#	Price
7mm	GSV-HSP-07S	SIL	1590	\$11.24
	GSV-HSP-07P	PU	1594	\$8.34
Nipples - Order Separately				
M5	GSF-HSN-M5F	Female	1598	\$6.11
	GSF-HSN-M5M	Male	1599	\$5.49

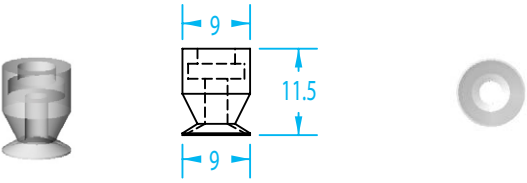

Pad øD	Part#	Material	Quick#	Price
9mm	GSV-HSP-09S	SIL	1591	\$6.50
	GSV-HSP-09P	PU	1595	\$8.20
Nipples - Order Separately				
M5	GSF-HSN-M5F	Female	1598	\$6.11
	GSF-HSN-M5M	Male	1599	\$5.49

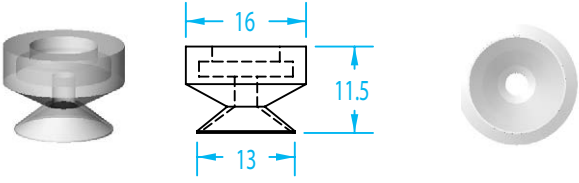

Pad øD	Part#	Material	Quick#	Price
13mm	GSV-HSP-13S	SIL	1592	\$7.40
	GSV-HSP-13P	PU	1596	\$9.20
Nipples - Order Separately				
G1/8"	GSF-HSN-G8F	Female	1601	\$5.70
	GSF-HSN-G8M	Male	1602	\$5.31

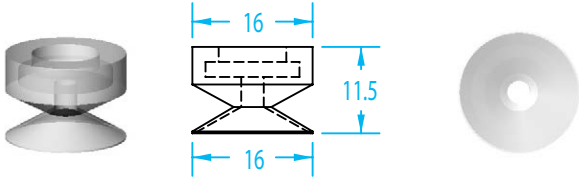

Pad øD	Part#	Material	Quick#	Price
16mm	GSV-HSP-16S	SIL	1593	\$8.19
	GSV-HSP-16P	PU	1597	\$9.85
Nipples - Order Separately				
G1/8"	GSF-HSN-G8F	Female	1601	\$5.70
	GSF-HSN-G8M	Male	1602	\$5.31

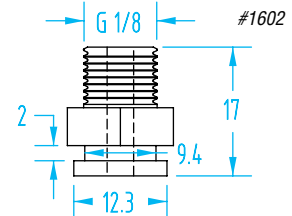
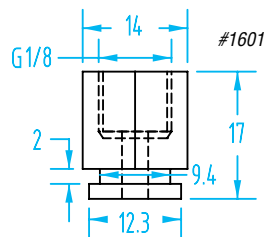
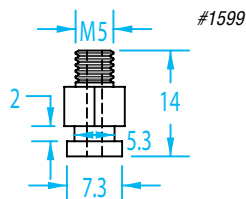
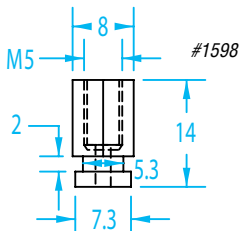

Packaging & Paper

(Shown Actual Size)

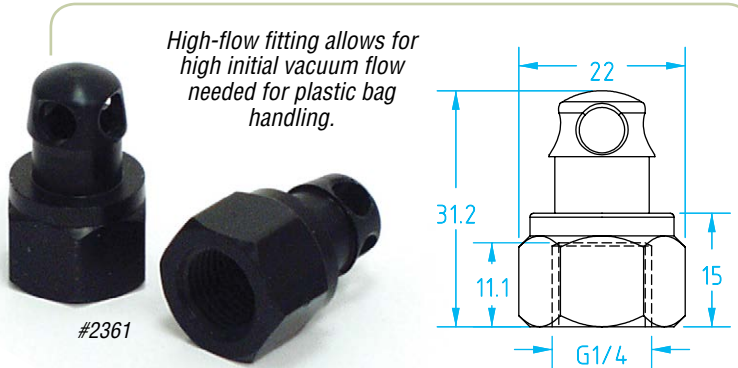

#2361

Nipples

Quick#	Part#	Thread	Weight	Price
2359	GSF-04AJ	G3/8" Male	11g	\$4.80
2360	GSF-04AL	3/8" NPT Male	11g	\$4.94
2361	GSF-NF8-G4F	G1/4" Female	10g	\$4.50



Dual Durometer Properties - Packaging & Paper

Material	Color	Max Temp.	Durometer
Dual Durometer Polyurethane	Black / Yellow	122°F	70° / 30° Shore

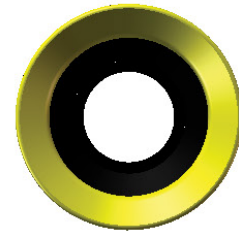
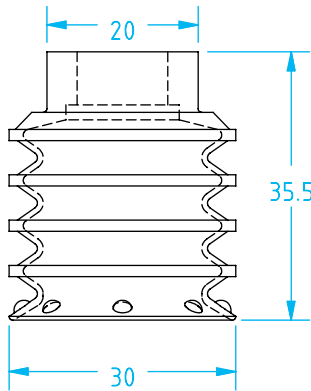

Pad øD	Part#	Material	Quick#	Weight	Price
30mm	GSV-BL30-3P-4L	Polyurethane	5448	5.9g	\$18.87

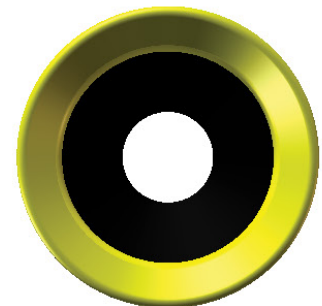
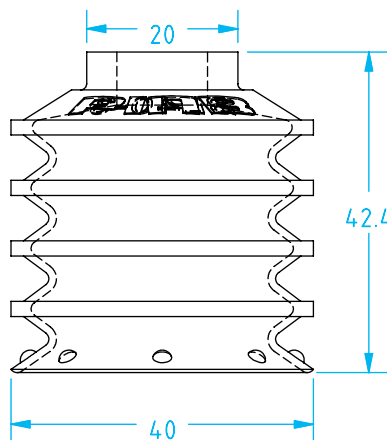

Pad øD	Part#	Material	Quick#	Weight	Price
40mm	GSV-BL40-3	Polyurethane	2358	12g	\$18.01

Paper and Foil Specialty

(Shown Actual Size)



These cups are specially designed for handling paper and foil. The soft, tapered sealing lips and the inner support on the bottom of the pad prevent the foil from being drawn in. The softer material ensures that the paper and foil is not creased or damaged.

Paper & Foil Vacuum Cup Properties

Material	Color	Max Temp.	Durometer
Natural Rubber	Beige	176°F	40°

Vacuum Cups

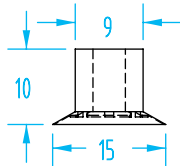

Pad øD	Part#	Quick#	Price
15mm	GSV-PFP-15NR	250	\$6.05
Nipples - Order Separately			
Female	GSF-PFN-G8F	1603	\$3.80
Male	GSF-PFN-G8M	1604	\$3.80

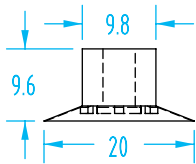

Pad øD	Part#	Quick#	Price
20mm	GSV-PFP-20NR	251	\$7.25
Nipples - Order Separately			
Female	GSF-PFN-G8F	1603	\$3.80
Male	GSF-PFN-G8M	1604	\$3.80

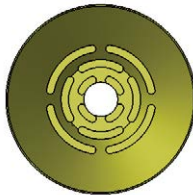
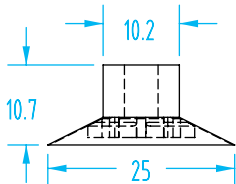

Pad øD	Part#	Quick#	Price
25mm	GSV-PFP-25NR	252	\$9.10
Nipples - Order Separately			
Female	GSF-PFN-G8F	1603	\$3.80
Male	GSF-PFN-G8M	1604	\$3.80

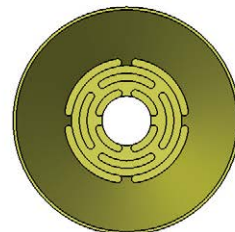
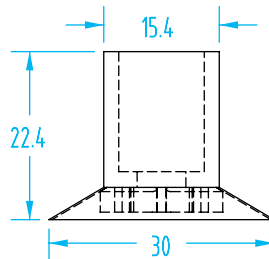
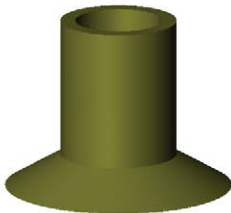

Pad øD	Part#	Quick#	Price
30mm	GSV-PFP-30NR	253	\$10.04
Nipples - Order Separately			
Female	GSF-PFN2-G4F	1605	\$6.49

Paper and Foil Specialty

(Shown Actual Size)

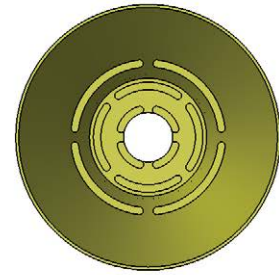
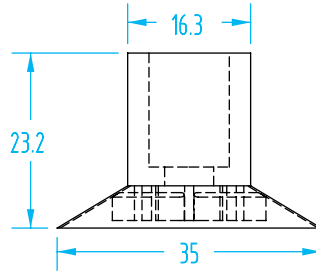
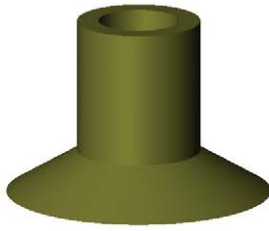

Pad øD	Part#	Quick#	Price
35mm	GSV-PFP-35NR	254	\$10.05
Nipples - Order Separately			
Female	GSF-PFN3-G4F	1606	\$6.95

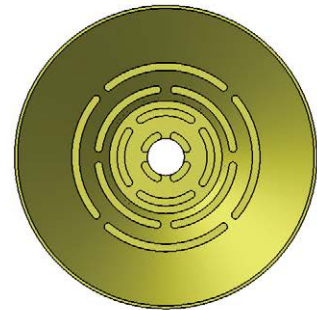
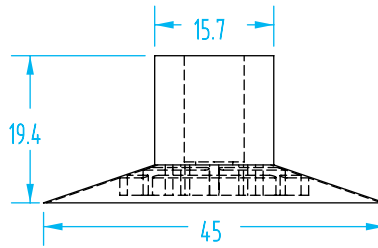
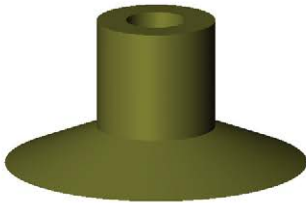

Pad øD	Part#	Quick#	Price
40mm	GSV-PFP-40NR	255	\$10.70
Nipples - Order Separately			
Female	GSF-PFN4-G4F	1607	\$6.42

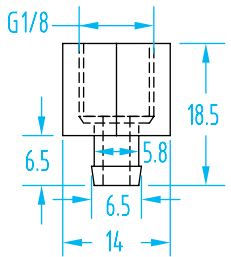

#1603

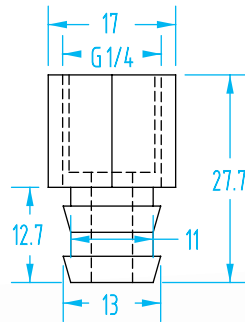

#1605

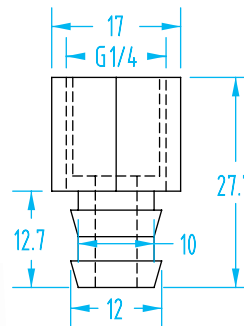

#1606

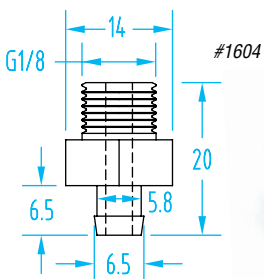

#1604

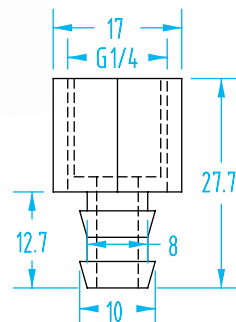

#1607



ACLA® - Polyurethane 1.5 Bellows

(Shown Actual Size)



ACLA Polyurethane

These polyurethane hybrid cups are an excellent value. These cups get 6X more life than silicone and 2X more life than other polyurethane cups. Yet the price premium is only about 1.3X more than other polyurethane cups.

The maximum temperature threshold is slightly higher than other PU cups. They are non-marking and contain no silicone so they are suitable to be used with parts that will be painted.

With a shore rating of 72°, ACLA-PU is a little stiffer than silicone and some other polyurethanes, so keep this in mind if your part is textured or deeply contoured.

ACLA Polyurethane Properties

Material	Color	Max Temp.	Durometer
ACLA-PU	Semi-translucent gold	212°F	72°

Vacuum Cups

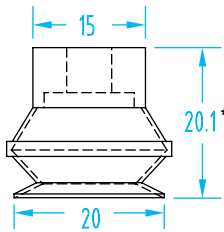

* 13mm Compressed



Quick#	Part#	Pad øD	Price	Male Nipple	Female Nipple
1764	GSV-BAPU-20	20mm	\$14.00	3292	5180

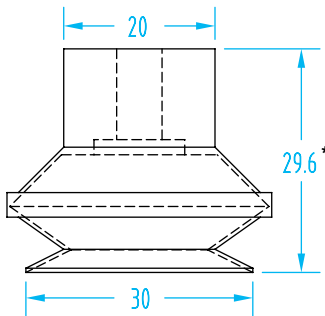
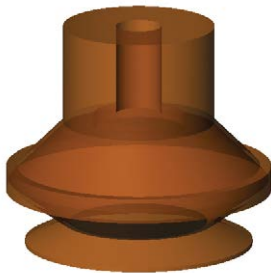

* 21mm Compressed



Quick#	Part#	Pad øD	Price	Male Nipple	Female Nipple
1765	GSV-BAPU-30	30mm	\$17.00	3292	5180

ACLA® - Polyurethane 1.5 Bellows

(Shown Actual Size)

* 28mm Compressed

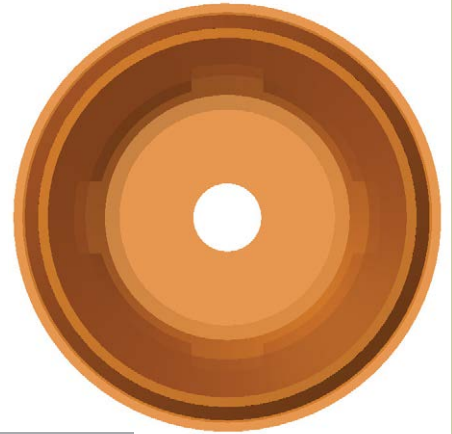
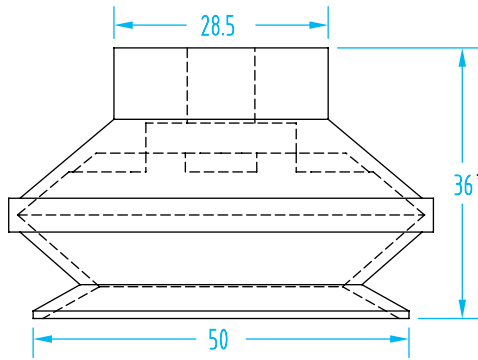
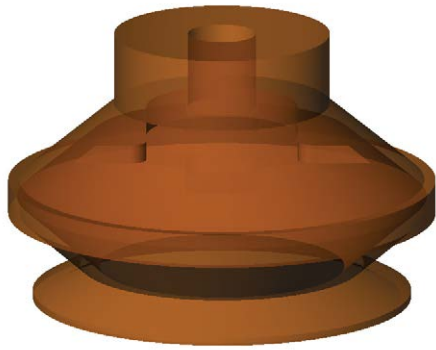

Quick#	Part#	Pad øD	Price	Male Nipple	Female Nipple
1767	GSV-BAPU-50	50mm	\$26.00	415	1841

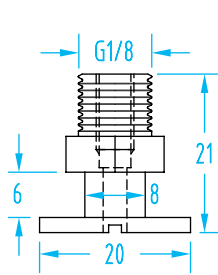

#415

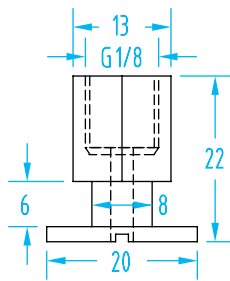
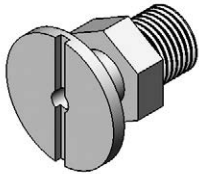

#1841

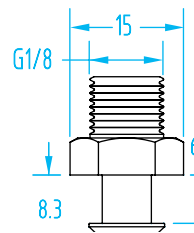
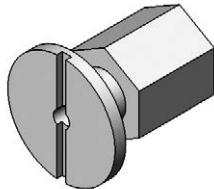

#3292

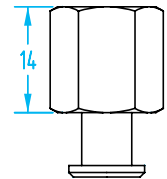

#5180

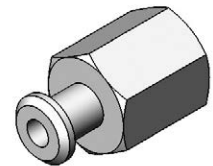

Nipples

Quick#	Part#	Nipple	Thread	Pad øD	Price
3292	VSA60	Male	G1/8"	20-30mm	\$3.17
5180	VSA60F	Female	G1/8"	20-30mm	\$3.33
415	GSF-NF4-G8	Male	G1/8"	50mm	\$7.92
1841	GSF-NM4-G8	Female	G1/8"	50mm	\$8.25

Fittings Available on page 935



ACLA® - Polyurethane 2.5 Bellows

(Shown Actual Size)



ACLA Polyurethane Properties

Material	Color	Max Temp.	Durometer
ACLA-PU	Semi-translucent gold	212°F	72°

Vacuum Cups

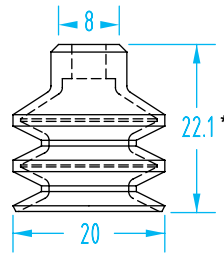

* 13mm Compressed

Quick#	Part#	Pad øD	Price
1768	GSV-2BAPU-20	20mm	\$14.50
Nipples - Order Separately			
408	GSF-N16-M5M	Male	\$3.35
666	GSF-NF6-G8F	Female	\$2.26
1604	GSF-PFN-G8M	Male	\$3.80

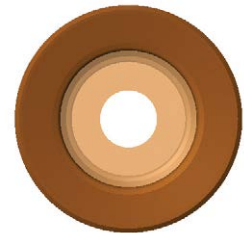
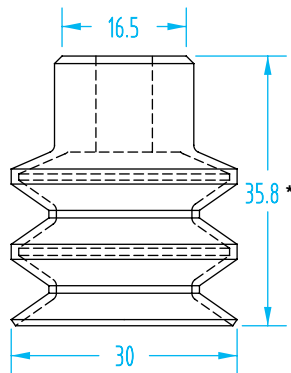
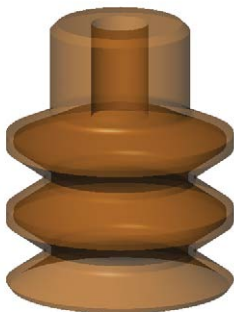

* 23mm Compressed

Quick#	Part#	Pad øD	Price
1769	GSV-2BAPU-30	30mm	\$16.00
Nipples - Order Separately			
327	GSF-VPN-53	Male	\$6.19
1842	GSF-VPN-F53	Female	\$7.35

ACLA® - Polyurethane 2.5 Bellows

(Shown Actual Size)

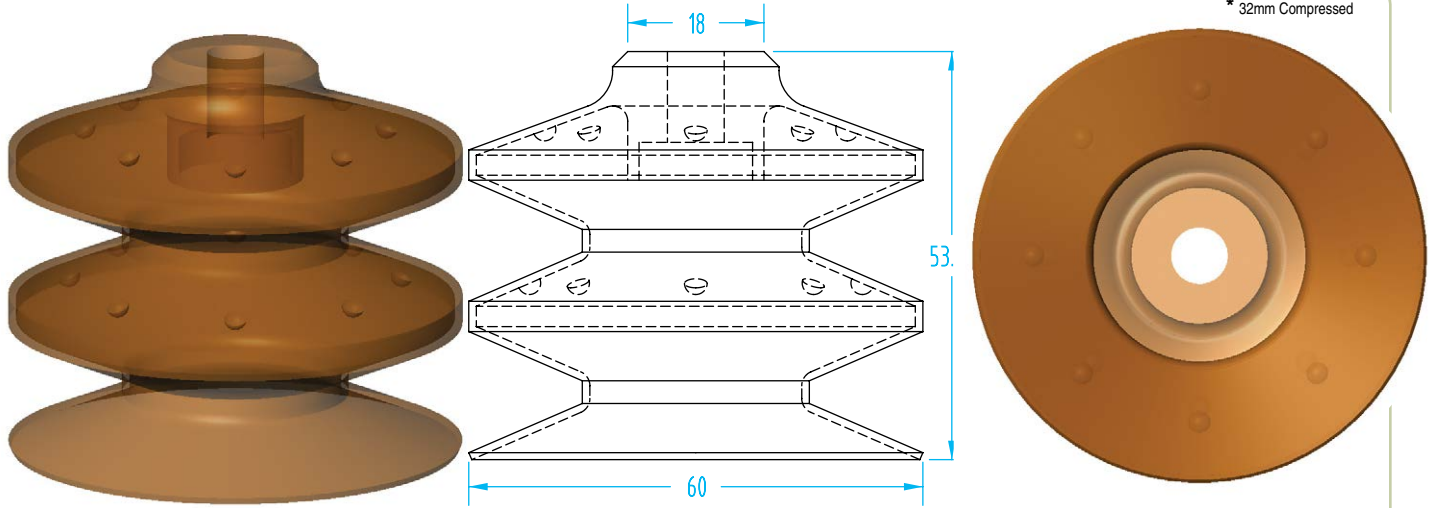

Quick#	Part#	Pad øD	Price
1770	GSV-2BAPU-60	60mm	\$33.00
Nipples - Order Separately			
327	GSF-VPN-53	Male	\$6.19
1842	GSF-VPN-F53	Female	\$7.35

Vacuum Cups

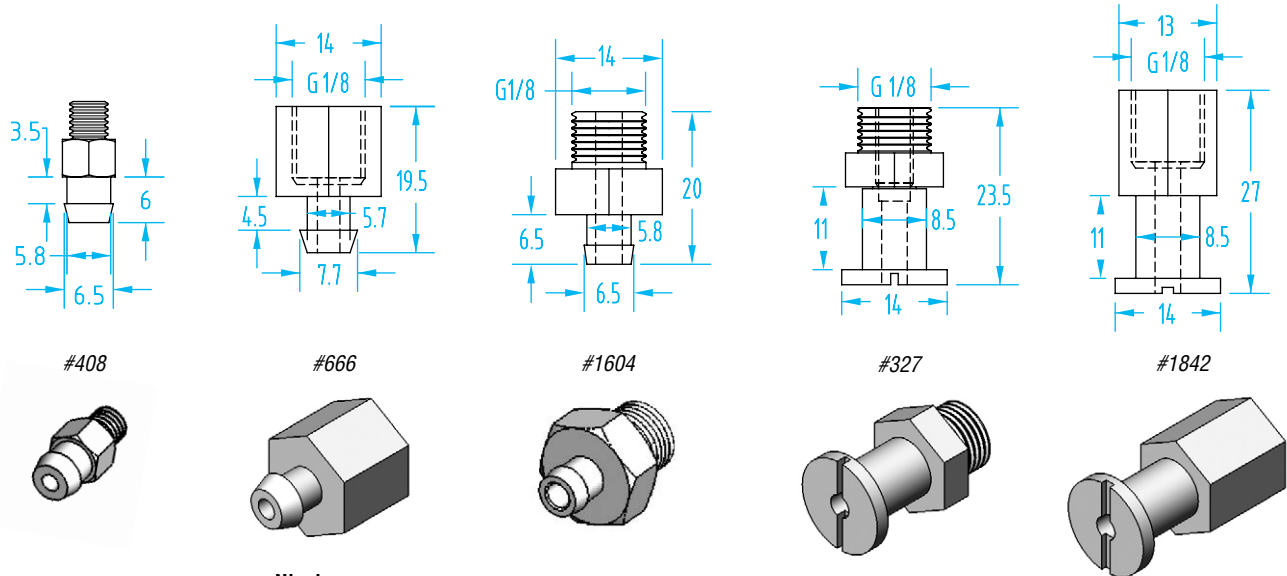

Nipples

Quick#	Part#	Nipple	Thread	Pad øD	Price
408	GSF-N16-M5M	Male	M5	20mm	\$3.35
666	GSF-NF6-G8F	Female	G1/8"	20mm	\$2.26
1604	GSF-PFN-G8M	Male	G1/8"	20mm	\$3.80
327	GSF-VPN-53	Male	G1/8"	30-60mm	\$6.19
1842	GSF-VPN-F53	Female	G1/8"	30-60mm	\$7.35

4.5 Bellows - Silicone

(Shown Actual Size)

4.5 Bellows Vacuum Cup Properties

Material	Color	Max Temp.	Durometer
Silicone	Semi-translucent white	392°F	50°

Use 4.5 bellows cups for significantly curved or angled parts. Remember, 4.5 bellows cups have a significant volume of air to evacuate before vacuum can be generated to grip the part, so attach and release times are greater.

* 12mm Compressed

Pad øD	Part#	Quick#	Price
20mm	GSV-4BS-20	1390	\$9.17
Nipples - Order Separately			
412	GSF-NF2-G8M5	Male/Female	\$5.00

* 14mm Compressed

Pad øD	Part#	Quick#	Price
30mm	GSV-4BS-30	1391	\$12.97
Nipples - Order Separately			
413	GSF-NF3-G8	Female	\$6.25

* 22mm Compressed

Pad øD	Part#	Quick#	Price
40mm	GSV-4BS-40	1392	\$16.67
Nipples - Order Separately			
413	GSF-NF3-G8	Female	\$6.25

4.5 Bellows - Silicone

(Shown Actual Size)

Pad øD	Part#	Quick#	Price
50mm	GSV-4BS-50	1393	\$23.75
Nipples - Order Separately			
Female	GSF-NF5-G8F	646	\$5.50

Vacuum Cups

Nipples for 4.5 Bellow Cups

Quick#	Part#	Nipple	Thread	Price
412	GSF-NF2-G8M5	Male / Female	G1/8" / M5	\$5.00
413	GSF-NF3-G8	Female	G1/8"	\$6.25
646	GSF-NF5-G8F	Female	G1/8"	\$5.50