

Suction cups / NBR-HNBR with ring in silicone foam

VG.LB16 bellows suction cups in NBR-HNBR with silicone foam ring

- Suitable for handling plastic parts
- Suitable for objects with flat or slightly curved surfaces
- They enable to compensate for differences in height
- Ideal for leafing through and picking up thin metal sheets, glass sheets, chipboard or pressed wood panels, plastic laminates
- The HNBR version enables to work at high temperatures, whereas silicone or other mixtures may release traces of material. Ideal for applications where contamination of the material must be avoided (PWIS)
- The HNBR compound is robust and wear resistant, suitable for the removal of hot plastic parts from the relevant moulds
- Ring in mark-free silicone foam

Application example

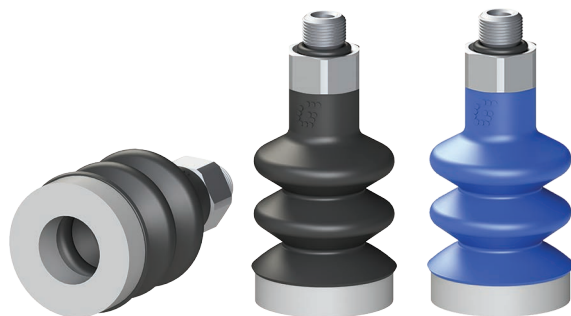
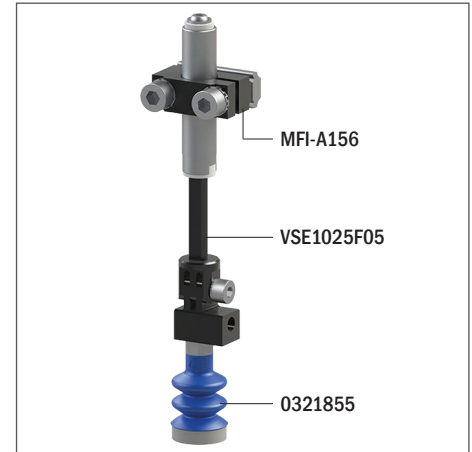

Technical features

Material	Colour	Hardness	Temperature range
NBR	Black	50 Shore	-40 ÷ +100 °C
HNBR	Blue	60 Shore	-25 ÷ +150 °C

Identification codes

Drawing	Alphanumeric code	Suction cups with fitting	Order code
A	VG.LB16N.50.M5F.E8.SFO	VG.LB16 suction cup, NBR, 50 Shore, M5 female, 8 mm hex with silicone foam ring	0321848
B	VG.LB16N.50.M5M.E8.SFO	VG.LB16 suction cup, NBR, 50 Shore, M5 male, 8 mm hex with silicone foam ring	0321850
C	VG.LB16N.50.G18F.E13.SFO	VG.LB16 suction cup, NBR, 50 Shore, G1/8" female, 13 mm hex with silicone foam ring	0321851
D	VG.LB16N.50.G18M.E13.SFO	VG.LB16 suction cup, NBR, 50 Shore, G1/8" male, 13 mm hex with silicone foam ring	0321852
A	VG.LB16H.60.M5F.E8.SFO	VG.LB16 suction cup, HNBR, 60 Shore, M5 female, 8 mm hex with silicone foam ring	0321853
B	VG.LB16H.60.M5M.E8.SFO	VG.LB16 suction cup, HNBR, 60 Shore, M5 male, 8 mm hex with silicone foam ring	0321855
C	VG.LB16H.60.G18F.E13.SFO	VG.LB16 suction cup, HNBR, 60 Shore, G1/8" female, 13 mm hex with silicone foam ring	0321856
D	VG.LB16H.60.G18M.E13.SFO	VG.LB16 suction cup, HNBR, 60 Shore, G1/8" male, 13 mm hex with silicone foam ring	0321857

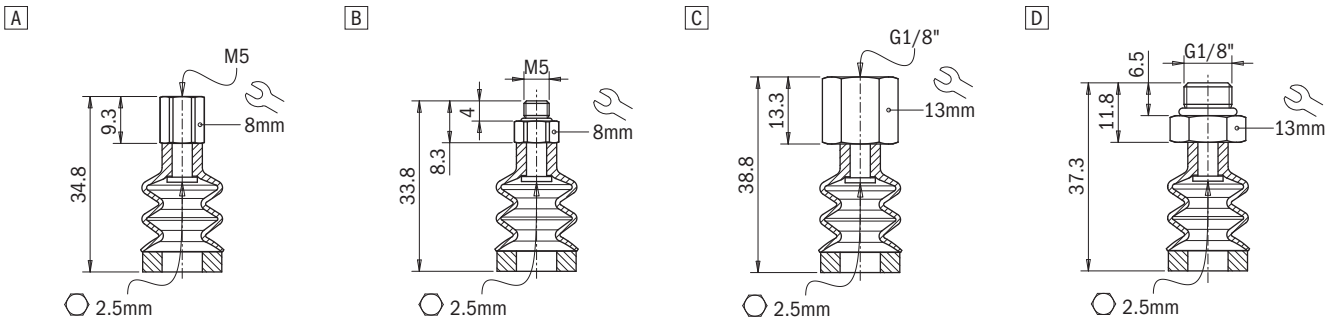

Identification codes

Drawing	Alphanumeric code	Suction cups	Order code
A	VG.LB16N.50.SFO	VG.LB16 suction cup, NBR, 50 Shore, with silicone foam ring	0321849
A	VG.LB16H.60.SFO	VG.LB16 suction cup, HNBR, 60 Shore, with silicone foam ring	0321854

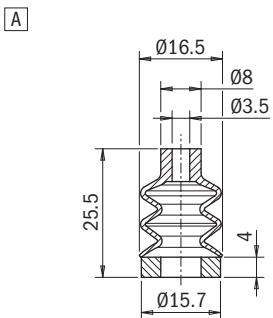

Identification codes

Drawing	Alphanumeric code	Fittings	Order code
A	FT.M5F.E8	M5 female fitting, 8 mm hex	2321408
B	FT.M5M.E8	M5 male fitting, 8 mm hex	2321410
C	FT.G18F.E13	G1/8" female fitting, 13 mm hex	2321412
D	FT.G18M.E13	G1/8" male fitting, 13 mm hex	2321414

