

Suction cups / NBR-HNBR with ring in silicone foam

VG.LB53 bellows suction cups in NBR-HNBR with silicone foam ring

- Suitable for handling plastic parts
- Suitable for objects with flat or slightly curved surfaces
- They enable to compensate for differences in height
- Ideal for leafing through and picking up thin metal sheets, glass sheets, chipboard or pressed wood panels, plastic laminates
- The HNBR version enables to work at high temperatures, whereas silicone or other mixtures may release traces of material. Ideal for applications where contamination of the material must be avoided (PWIS)
- The HNBR compound is robust and wear resistant, suitable for the removal of hot plastic parts from the relevant moulds
- Ring in mark-free silicone foam

Application example



Technical features

Material	Colour	Hardness	Temperature range
NBR	Black	50 Shore	-40 ÷ +100 °C
HNBR	Blue	60 Shore	-25 ÷ +150 °C

Identification codes

Drawing	Alphanumeric code	Suction cups with fitting	Order code
A	VG.LB53N.50.G18F.E12.SFO	VG.LB53 suction cup, NBR, 50 Shore, G1/8" female, 12 mm hex with silicone foam ring	0321900
B	VG.LB53N.50.G18M.E12.SFO	VG.LB53 suction cup, NBR, 50 Shore, G1/8" male, 12 mm hex with silicone foam ring	0321902
C	VG.LB53N.50.G18F.E16.SFO	VG.LB53 suction cup, NBR, 50 Shore, G1/8" female, 16 mm hex with silicone foam ring	0321903
D	VG.LB53N.50.G18M.E16.SFO	VG.LB53 suction cup, NBR, 50 Shore, G1/8" male, 16 mm hex with silicone foam ring	0321904
E	VG.LB53N.50.G14F.E16.SFO	VG.LB53 suction cup, NBR, 50 Shore, G1/4" female, 16 mm hex with silicone foam ring	0321905
F	VG.LB53N.50.G14M.E17.SFO	VG.LB53 suction cup, NBR, 50 Shore, G1/4" male, 17 mm hex with silicone foam ring	0321906
A	VG.LB53H.60.G18F.E12.SFO	VG.LB53 suction cup, HNBR, 60 Shore, G1/8" female, 12 mm hex with silicone foam ring	0321907
B	VG.LB53H.60.G18M.E12.SFO	VG.LB53 suction cup, HNBR, 60 Shore, G1/8" male, 12 mm hex with silicone foam ring	0321909
C	VG.LB53H.60.G18F.E16.SFO	VG.LB53 suction cup, HNBR, 60 Shore, G1/8" female, 16 mm hex with silicone foam ring	0321910
D	VG.LB53H.60.G18M.E16.SFO	VG.LB53 suction cup, HNBR, 60 Shore, G1/8" male, 16 mm hex with silicone foam ring	0321911
E	VG.LB53H.60.G14F.E16.SFO	VG.LB53 suction cup, HNBR, 60 Shore, G1/4" female, 16 mm hex with silicone foam ring	0321912
F	VG.LB53H.60.G14M.E17.SFO	VG.LB53 suction cup, HNBR, 60 Shore, G1/4" male, 17 mm hex with silicone foam ring	0321913

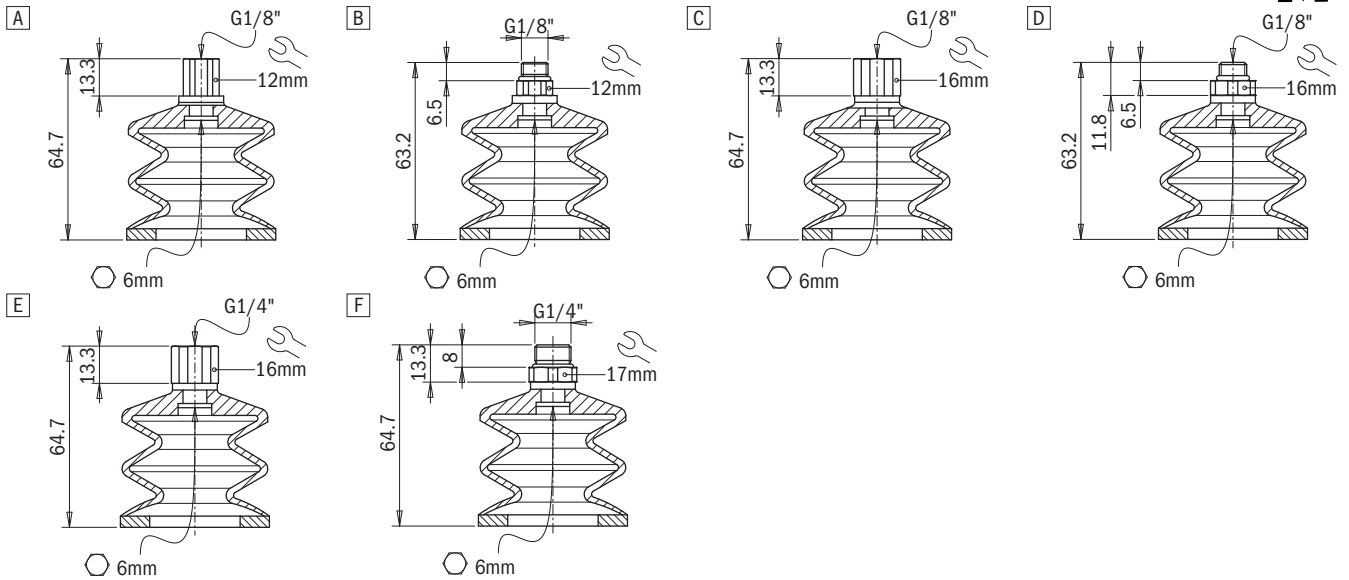

Identification codes

Drawing	Alphanumeric code	Suction cups	Order code
A	VG.LB53N.50.SFO	VG.LB53 suction cup, NBR, 50 Shore, with silicone foam ring	0321901
A	VG.LB53H.60.SFO	VG.LB53 suction cup, HNBR, 60 Shore, with silicone foam ring	0321908

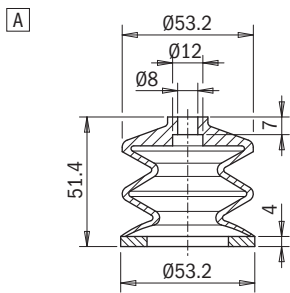

Identification codes

Drawing	Alphanumeric code	Fittings	Order code
A	FT.G18F.E12	G1/8" female fitting, 12 mm hex	2321422
B	FT.G18M.E12	G1/8" male fitting, 12 mm hex	2321424
C	FT.G18F.E16	G1/8" female fitting, 16 mm hex	2321426
D	FT.G18M.E16	G1/8" male fitting, 16 mm hex	2321428
E	FT.G14F.E16	G1/4" female fitting, 16 mm hex	2321430
F	FT.G14M.E17	G1/4" male fitting, 17 mm hex	2321432

