

Non-Rotating Suspensions – VSNTG

(Dimensioned drawings shown full scale)

- Body and rod are made of anodized aluminum.
- High-load capability
- Threaded body
- FDA-H1 food-grade lubricant.
- We recommend using an appropriately sized lock washer with threaded suspensions, see page 238.

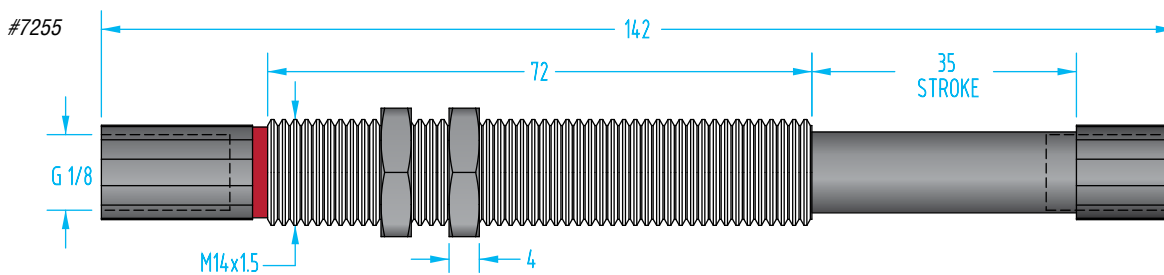
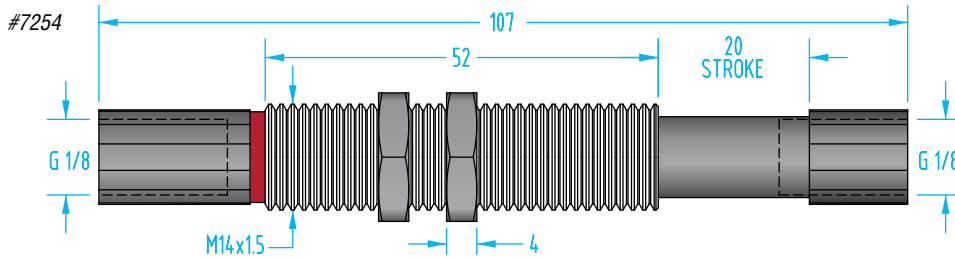
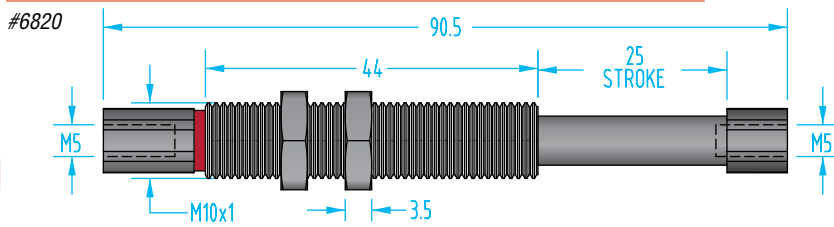
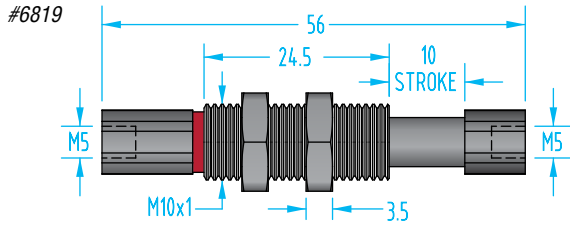

| Quick# | Part# | Price | Air Port | ØD | Stroke | Wt. |
|--------|----------------|---------|----------|---------|--------|------|
| 6819 | VSNTG-1010 | \$27.60 | M5 | M10x1 | 10mm | 7g |
| 6820 | VSNTG-1025 | \$30.10 | M5 | M10x1 | 25mm | 11g |
| 7254 | VSNTG-1420 | \$38.80 | G1/8" | M14x1.5 | 20mm | 22g |
| 7255 | VSNTG-1435 | \$44.00 | G1/8" | M14x1.5 | 35mm | 33g |
| 7202 | VSNTG-1620 | \$38.80 | G1/8" | M16x1 | 20mm | 35g |
| 7203 | VSNTG-1635 | \$44.00 | G1/8" | M16x1 | 35mm | 45g |
| 7256 | VSNTG-2025-F18 | \$46.40 | G1/8" | M20x1.5 | 25mm | 54g |
| 7257 | VSNTG-2050-F18 | \$49.00 | G1/8" | M20x1.5 | 50mm | 80g |
| 7204 | VSNTG-2025 | \$46.40 | G1/4" | M20x1.5 | 25mm | 65g |
| 7205 | VSNTG-2050 | \$49.00 | G1/4" | M20x1.5 | 50mm | 90g |
| 7206 | VSNTG-2540* | \$70.00 | G3/8" | M25x1.5 | 40mm | 170g |
| 7207 | VSNTG-2580* | \$89.00 | G3/8" | M25x1.5 | 80mm | 235g |

*Dimensional information available online.

Mounting Brackets
Available on
page 194



Non-Rotating Suspensions – VSNTG

(Dimensioned drawings shown full scale)



#7202

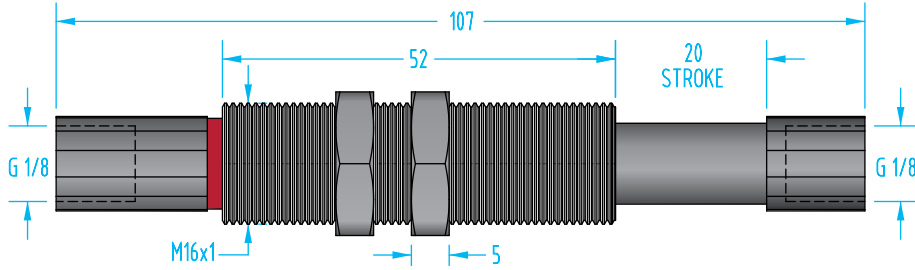

#7203

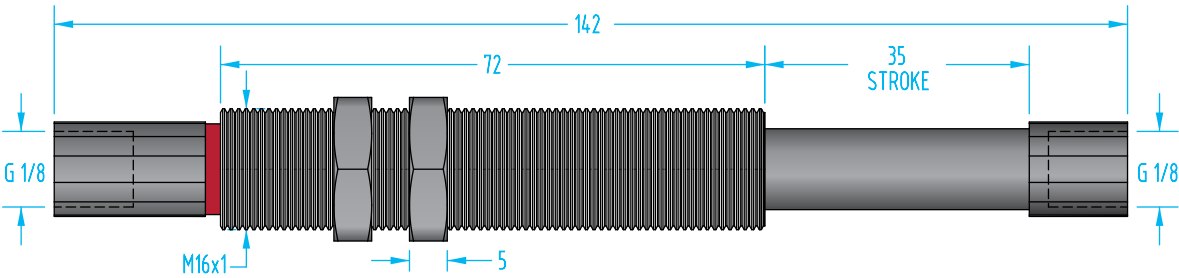

#7256

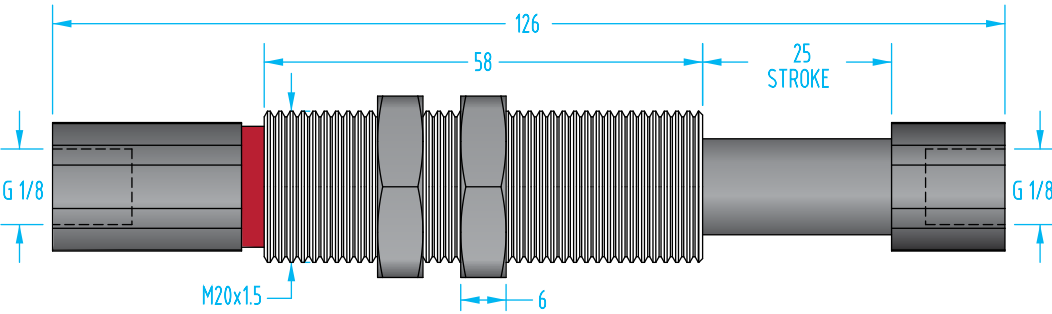

Note: Quick #7204 has the same dimensions except with G1/4" air ports

#7257

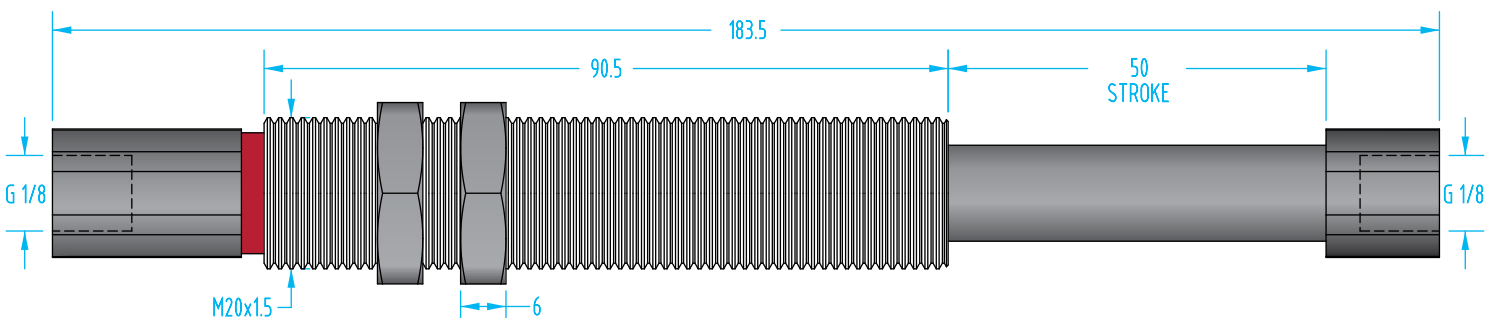

Note: Quick #7205 has the same dimensions except with G1/4" air ports