

Star® – Nipples and Suspensions

(Shown Actual Size)

“Mini” Suspensions

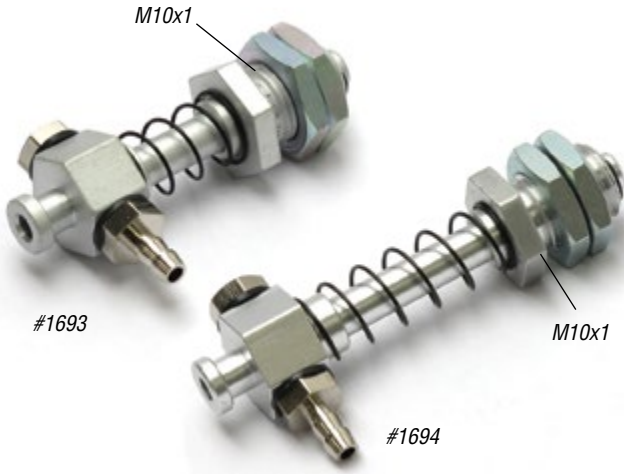

See EMIcorp.com for dimensional drawings

“Small” Suspensions



Lightweight Aluminum Suspensions

Quick#	Part#	Size	Stroke	Weight	Price
5399	GSV-VFIL-SS-5	Mini	5mm	14g	\$11.86
1693	GSV-VFIL-SS10	Mini	10mm	14g	\$12.55
1694	GSV-VFIL-SS20	Mini	20mm	16g	\$13.43
5275	GSV-VFIL-SS30	Mini	30mm	20g	\$13.69
5500	GSV-VFIL-S	Small	5mm	20g	\$7.80
1695	GSV-VFIL-S10	Small	10mm	20g	\$13.55
1696	GSV-VFIL-S20	Small	20mm	24g	\$10.26
5276	GSV-VFIL-S30	Small	30mm	30g	\$13.43

See EMIcorp.com for dimensional drawings

“Mini”

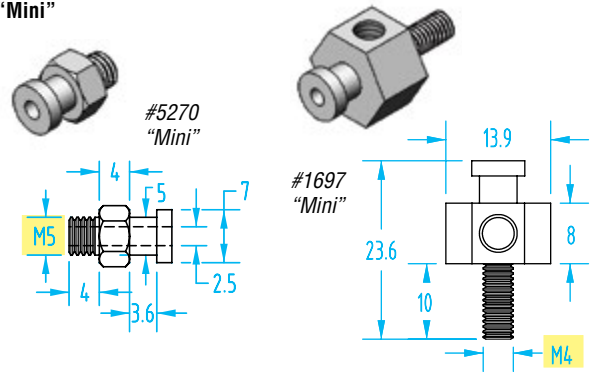

“Small”

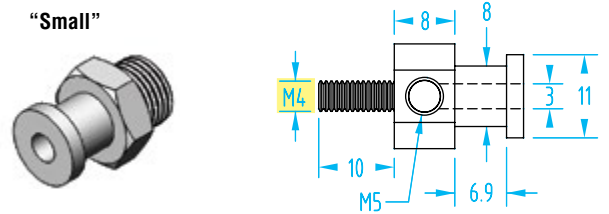

#5271
“Small”

#1698
“Small”

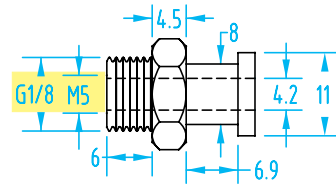

Threaded Stem Nipples

Quick#	Part#	Size	Price	Thread	Wt.
1697	GSV-CP-063	Mini	\$7.20	M4 Male	8g
5270	GSV-CP-063-M5	Mini	\$1.20	M5 Male	3g
1698	GSV-CP-064	Small	\$7.20	M4 Male	10g
5271	GSV-CP-064-G8	Small	\$5.80	G1/8”-M5	4g



#1700



#1704

Extension Mounts for Suspensions

Quick#	Part#	Size	Threaded Extension	Thread	Price
1701	GSV-CP-023AL	Mini	20mm	M10x1	\$9.21
1702	GSV-CP-024AL	Mini	40mm	M10x1	\$9.58
1699	GSV-CP-021AL	Small	20mm	M12x1	\$9.21
1700	GSV-CP-022AL	Small	40mm	M12x1	\$9.58

Lock nuts for extension mounts (order separately 2@)

1704	GSV-M10nut	Mini		M10x1	\$0.36
1703	GSV-M12nut	Small		M12x1	\$0.36