

MG – Blades



Two blade styles are offered, standard and offset. These blades can only be installed in the nippers one way (these MG-type nippers differ from the ME-type in this manner).

Note, the FG_ and FG_K blades are for use only with MG style nippers.

Standard Blades



Blades for MG Nippers

Quick#	Part#	Nipper Body	Blade Style	Price
1611	GSN-FG10	MG-3	Standard	\$91.00
1612	GSN-FG10K		Offset	\$91.00
1613	GSN-FG3	MG-10	Standard	\$96.00
1614	GSN-FG3K		Offset	\$96.00
1615	GSN-FG5	MG-20	Standard	\$84.50
1616	GSN-FG5K		Offset	\$84.50

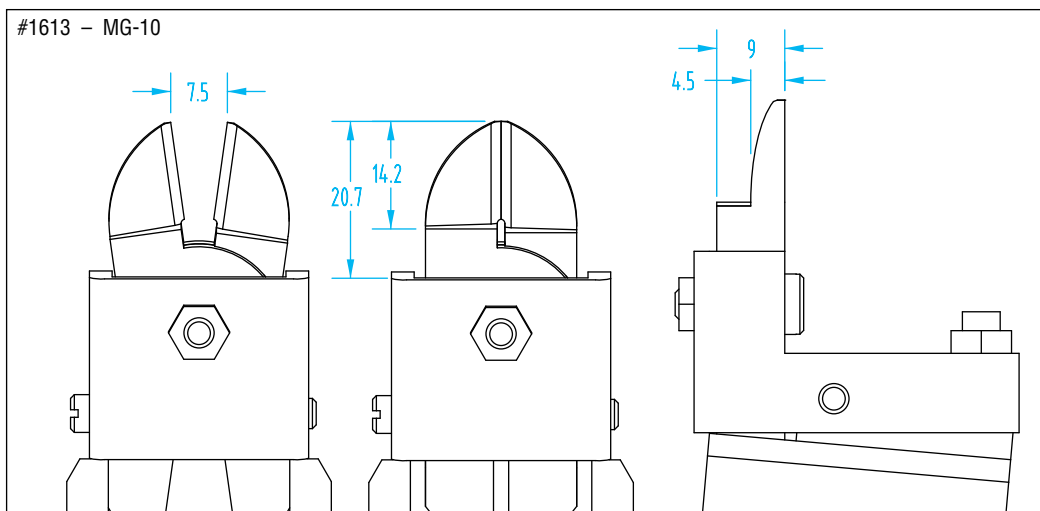
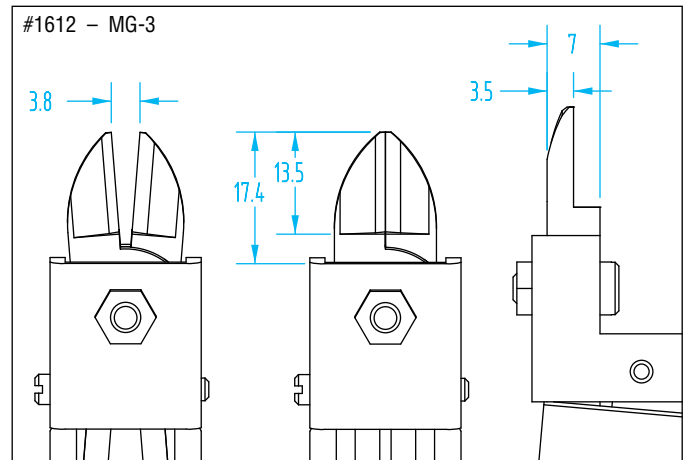
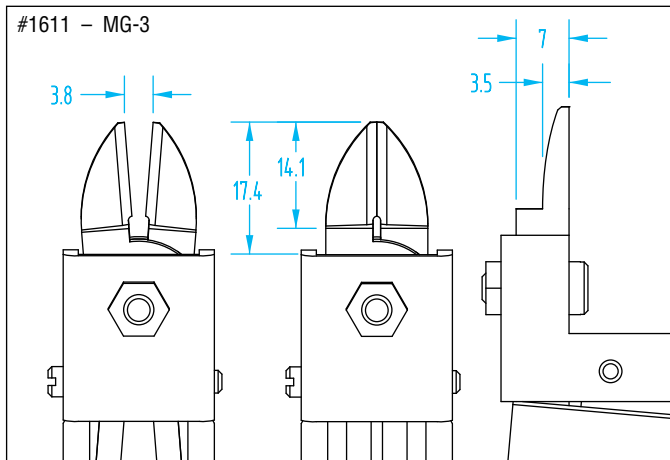

MG – Blades

